

SAMSUNG

VRF

Technical Data Book

**DVM S2 for Europe
(R410A, 50Hz, HP)**



Model : Premium energy efficiency / Standard Type

History

Version	Modification	Date	Remark
Ver.1.0	Release DVM S2 (R410A, 50Hz, HP) for Europe TDB	20.12.02	
Ver.2.0	Updated all contents (Final Specification)	21.02.05	
Ver.3.0	Updated the Non-ducted spec in Specification page	21.07.05	

Nomenclature

Outdoor Unit

Model Name

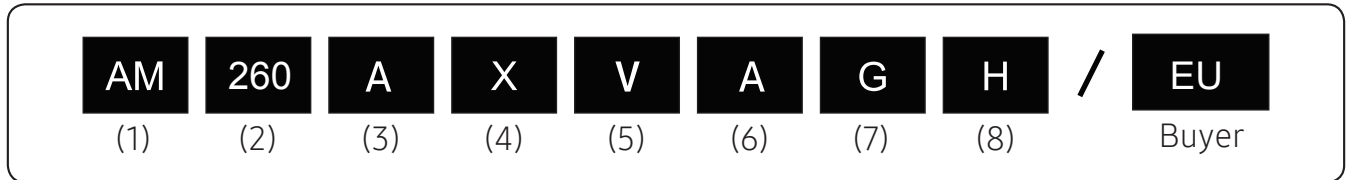

(1) Classification

AM	DVM
-----------	-----

(5) Feature 1

V	Inverter
----------	----------

(2) Capacity

x 1/10 HP (3 digits)

(6) Feature 2

A	Standard + General Temp. + Module
H	High EER + Low Temp. + Module
G	High EER + General Temp. + Module
D	Standard + General Temp. + Non-Module

(3) Version

A	2021
----------	------

(7) Rating Voltage

E	1Ø, 220~240V, 50Hz
G	3Ø, 380~415V, 50Hz
N	3Ø, 380~415V, 50/60Hz

(4) Product Type

X	Outdoor Unit
N	Indoor Unit

(8) Mode

H	Heat Pump
R	Heat Recovery

Features & Benefits

Rebuilt on all new innovations

Rethink your approach to air conditioning with the Samsung DVM S2. It delivers outstanding comfort and energy efficiency, even in extreme climates. Its intelligent features make installation and maintenance easier and more cost-effective.



Perfectly compatible with WindFree™

Active Frequency Drive 10Hz

Enjoy continuous comfort and avoid wasting energy. Active Frequency Drive 10Hz technology enables the compressor to precisely control a small amount of refrigerant. So it maintains a more consistent temperature and is compatible with Samsung's WindFree™ Cooling.

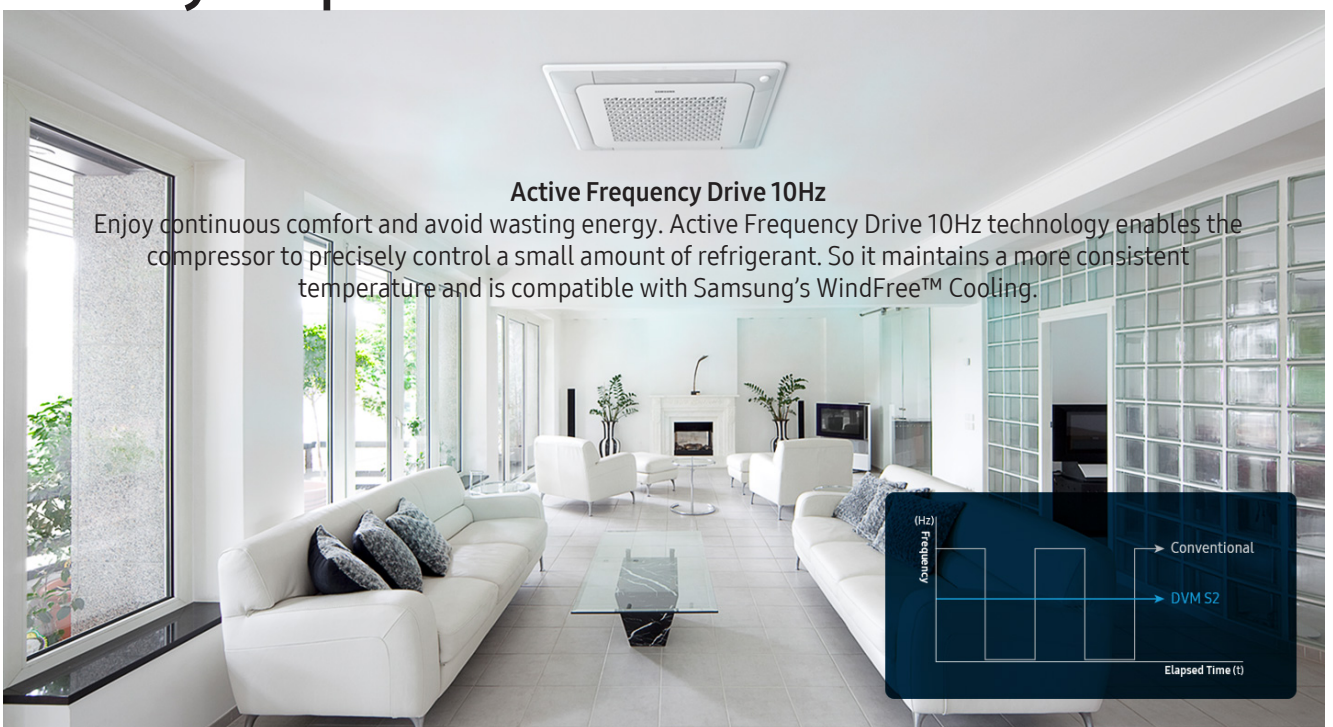

Features & Benefits

Enabling a new era of consistent comfort

Advanced Flash Injection Compressor

Enter a new era of non-stop comfort and efficiency. The Advanced Flash Injection Compressor provides the world's largest capacity*. It combines Flash Injection technology with a strengthened Triple Profile Scroll and efficient Optimal Discharge Superheat (DSH) Control technology.

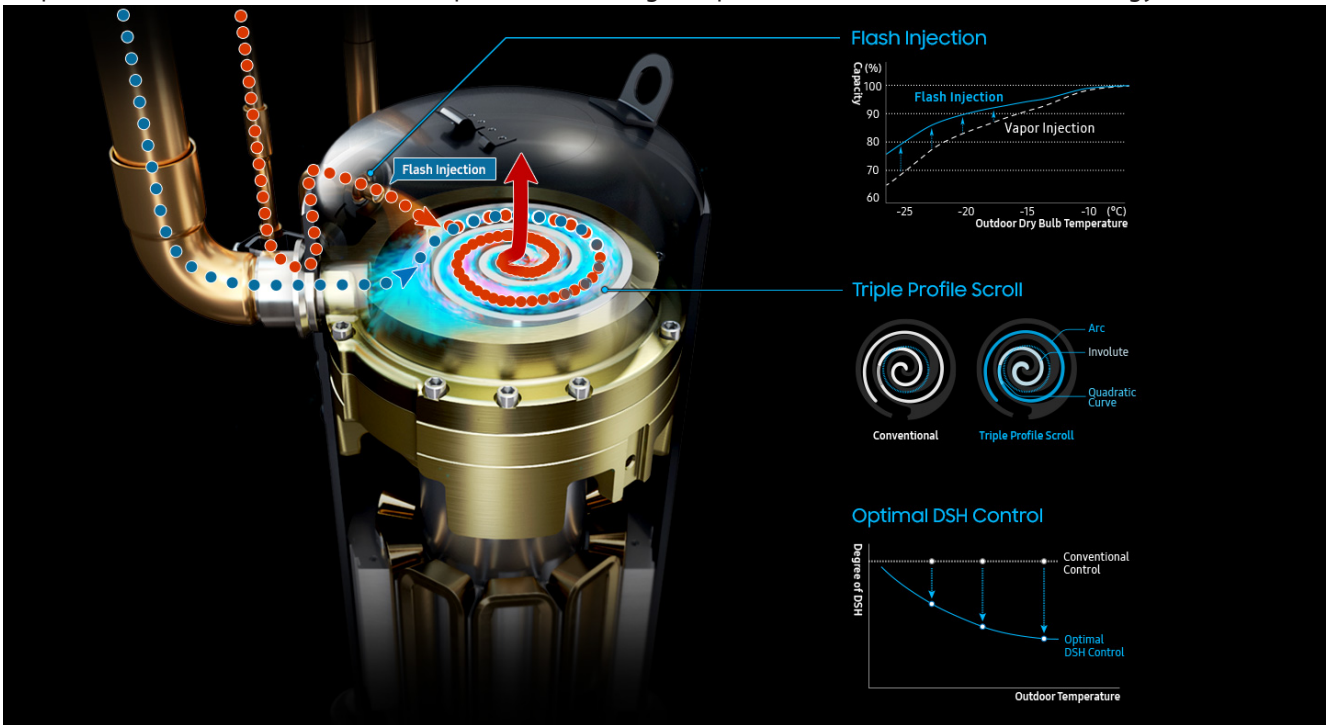

* Samsung circulates 14,400cc/sec refrigerant (= 90cc (displacement volume) x 160rps (revolutions per second)), while Company A circulates 12,480cc/sec (= 96cc x 130rps), Company B circulates 14,080cc/sec (= 88cc x 160rps) and Company C circulates 12,320cc/sec (= 88cc x 140rps).

More powerful performance, less space

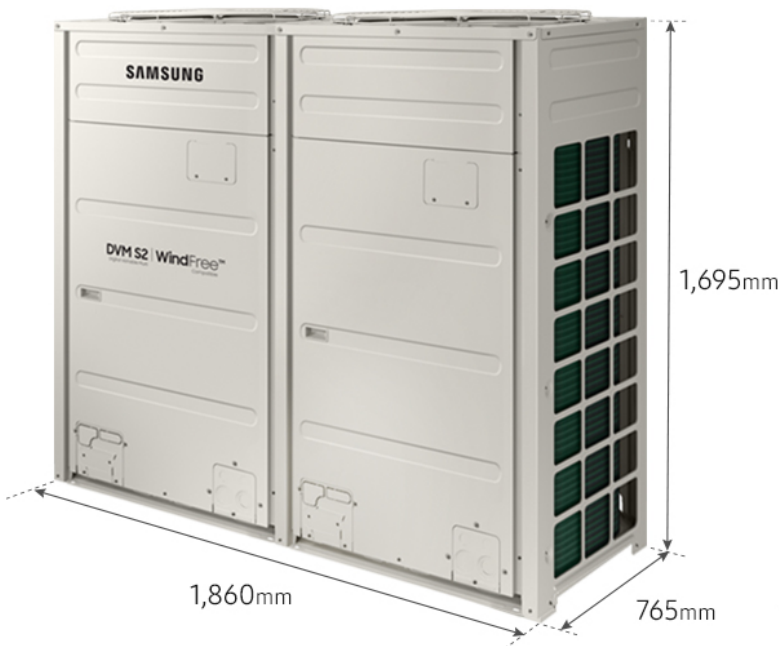

34HP Super Capacity with a Compact Design

Enjoy an exceptionally powerful performance and use less space. It's the first outdoor unit to offer super capacities of 32HP and 34HP in a single unit. Their compact design saves up to 18% space* and helps reduce the cost and effort of installation.

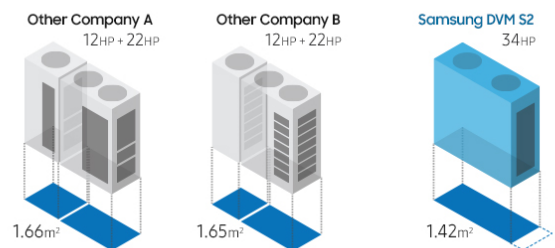

* Based on internal testing compared to both Samsung conventional outdoor units and those of other brands.

Contents

1. Combination Table / Design Procedure & Combination Ratio	7
2. Specification	15
3. Electric Characteristics	79
4. Dimensional Drawing	81
5. Center of Gravity	84
6. Electrical Wiring Diagrams	87
7. Sound Data	92
8. Operation Range	105
9. Piping Diagram	107
10. Installation	113

1. Combination Table

Premium energy efficiency

System Model			Capacity (HP)									
Capa	Model Name	Number of individual outdoor units	8	10	12	14	16	18	20	22	24	26
8HP	AM080AXVGGH/EU	1	1									
10HP	AM100AXVGGH/EU	1		1								
12HP	AM120AXVGGH/EU	1			1							
14HP	AM140AXVGGH/EU	1				1						
16HP	AM160AXVGGH/EU	1					1					
18HP	AM180AXVGGH/EU	1						1				
20HP	AM200AXVGGH/EU	1							1			
22HP	AM220AXVGGH/EU	1								1		
24HP	AM240AXVGGH/EU	1									1	
26HP	AM260AXVGGH/EU	1										1
28HP	AM280AXVGGH1EU	2		1				1				
30HP	AM300AXVGGH1EU	2			1			1				
32HP	AM320AXVGGH1EU	2			1				1			
34HP	AM340AXVGGH1EU	2					1	1				
36HP	AM360AXVGGH1EU	2						2				
38HP	AM380AXVGGH1EU	2						1	1			
40HP	AM400AXVGGH1EU	2							2			
42HP	AM420AXVGGH1EU	2							1	1		
44HP	AM440AXVGGH1EU	2						1				1
46HP	AM460AXVGGH1EU	2							1			1
48HP	AM480AXVGGH1EU	2								1		1
50HP	AM500AXVGGH1EU	2									1	1
52HP	AM520AXVGGH1EU	2										2
54HP	AM540AXVGGH1EU	3		1				1				1
56HP	AM560AXVGGH1EU	3			1			1				1
58HP	AM580AXVGGH1EU	3			1				1			1
60HP	AM600AXVGGH1EU	3			1					1		1
62HP	AM620AXVGGH1EU	3		1								2
64HP	AM640AXVGGH1EU	3			1							2
66HP	AM660AXVGGH1EU	3							2			1
68HP	AM680AXVGGH1EU	3							1	1		1
70HP	AM700AXVGGH1EU	3						1				2
72HP	AM720AXVGGH1EU	3							1			2
74HP	AM740AXVGGH1EU	3								1		2
76HP	AM760AXVGGH1EU	3									1	2
78HP	AM780AXVGGH1EU	3										3
80HP	AM800AXVGGH1EU	4				1			2			1
82HP	AM820AXVGGH1EU	4					1		2			1
84HP	AM840AXVGGH1EU	4						1	2			1
86HP	AM860AXVGGH1EU	4							3			1
88HP	AM880AXVGGH1EU	4						2				2
90HP	AM900AXVGGH1EU	4						1	1			2
92HP	AM920AXVGGH1EU	4							2			2
94HP	AM940AXVGGH1EU	4							1	1		2
96HP	AM960AXVGGH1EU	4						1				3
98HP	AM980AXVGGH1EU	4							1			3

NOTE

- Make sure to use an indoor unit that is compatible with DVM S.
- Indoor units can be connected within the range indicated in following table.
- If the total capacity of the connected indoor units exceeds the indicated maximum capacity, cooling and heating capacity of the indoor unit may decrease.
- Total capacity of the connected indoor units can be allowed from 50% to 130% of the total outdoor unit capacity.
 $0.5 \times \Sigma(\text{Outdoor unit capacity}) \leq \text{Total capacity of the connected indoor units} \leq 1.3 \times \Sigma(\text{Outdoor unit capacity})$
 - ※ You can connect maximum 64 indoor units to the outdoor unit. Maximum quantity of connectable indoor unit is set to 64 since outdoor unit only support up to 64 communication address. Indoor unit address can be assigned from 0~63. If the indoor unit address was assigned from 64~79, E201 error will occur.
 - ※ Maximum 32 Wall-mount type indoor units with EEV (AM***XNQDEH***, AM***XJNVDKH***) can be connected.

1. Combination Table

Standard

System Model			Capacity (HP)									
Capa	Model Name	Number of individual outdoor units	8	10	12	14	16	18	20	22	24	26
8HP	AM080AXVAGH/EU	1	1									
10HP	AM100AXVAGH/EU	1		1								
12HP	AM120AXVAGH/EU	1			1							
14HP	AM140AXVAGH/EU	1				1						
16HP	AM160AXVAGH/EU	1					1					
18HP	AM180AXVAGH/EU	1						1				
20HP	AM200AXVAGH/EU	1							1			
22HP	AM220AXVAGH/EU	1								1		
24HP	AM240AXVAGH/EU	1									1	
26HP	AM260AXVAGH/EU	1										1
28HP	AM280AXVAGH1EU	2	1						1			
30HP	AM300AXVAGH1EU	2			1			1				
32HP	AM320AXVAGH1EU	2	1								1	
34HP	AM340AXVAGH1EU	2		1							1	
36HP	AM360AXVAGH1EU	2			1						1	
38HP	AM380AXVAGH1EU	2				1					1	
40HP	AM400AXVAGH1EU	2					1				1	
42HP	AM420AXVAGH1EU	2						1			1	
44HP	AM440AXVAGH1EU	2							1		1	
46HP	AM460AXVAGH1EU	2								1	1	
48HP	AM480AXVAGH1EU	2									2	
50HP	AM500AXVAGH1EU	2									1	1
52HP	AM520AXVAGH1EU	2										2
54HP	AM540AXVAGH1EU	3			1			1			1	
56HP	AM560AXVAGH1EU	3	1								2	
58HP	AM580AXVAGH1EU	3		1							2	
60HP	AM600AXVAGH1EU	3			1						2	
62HP	AM620AXVAGH1EU	3				1					2	
64HP	AM640AXVAGH1EU	3					1				2	
66HP	AM660AXVAGH1EU	3						1			2	
68HP	AM680AXVAGH1EU	3							1		2	
70HP	AM700AXVAGH1EU	3								1	2	
72HP	AM720AXVAGH1EU	3									3	
74HP	AM740AXVAGH1EU	3									2	1
76HP	AM760AXVAGH1EU	3									1	2
78HP	AM780AXVAGH1EU	3										3
80HP	AM800AXVAGH1EU	4	1								3	
82HP	AM820AXVAGH1EU	4		1							3	
84HP	AM840AXVAGH1EU	4			1						3	
86HP	AM860AXVAGH1EU	4				1					3	
88HP	AM880AXVAGH1EU	4					1				3	
90HP	AM900AXVAGH1EU	4						1			3	
92HP	AM920AXVAGH1EU	4							1		3	
94HP	AM940AXVAGH1EU	4								1	3	
96HP	AM960AXVAGH1EU	4									4	
98HP	AM980AXVAGH1EU	4									3	1



NOTE

- Make sure to use an indoor unit that is compatible with DVM S.
- Indoor units can be connected within the range indicated in following table.
- If the total capacity of the connected indoor units exceeds the indicated maximum capacity, cooling and heating capacity of the indoor unit may decrease.
- Total capacity of the connected indoor units can be allowed from 50% to 130% of the total outdoor unit capacity.
 $0.5 \times \Sigma(\text{Outdoor unit capacity}) \leq \text{Total capacity of the connected indoor units} \leq 1.3 \times \Sigma(\text{Outdoor unit capacity})$
 - ※ You can connect maximum 64 indoor units to the outdoor unit. Maximum quantity of connectable indoor unit is set to 64 since outdoor unit only support up to 64 communication address. Indoor unit address can be assigned from 0~63. If the indoor unit address was assigned from 64~79, E201 error will occur.
 - ※ Maximum 32 Wall-mount type indoor units with EEV (AM***NQE***, AM***JNVK***) can be connected.

1. Combination Table

External Appearance

Premium energy efficiency

Capa [HP]	Model Name	Model	Capa [HP]	Model Name	Model
8 10 12	AM080AXVGGH/EU AM100AXVGGH/EU AM120AXVGGH/EU		54 56 58 60 62 64	AM540AXVGGH1EU AM560AXVGGH1EU AM580AXVGGH1EU AM600AXVGGH1EU AM620AXVGGH1EU AM640AXVGGH1EU	
14 16 18 20 22 24 26	AM140AXVGGH/EU AM160AXVGGH/EU AM180AXVGGH/EU AM200AXVGGH/EU AM220AXVGGH/EU AM240AXVGGH/EU AM260AXVGGH/EU		66 68 70 72 74 76 78	AM660AXVGGH1EU AM680AXVGGH1EU AM700AXVGGH1EU AM720AXVGGH1EU AM740AXVGGH1EU AM760AXVGGH1EU AM780AXVGGH1EU	
28 30 32	AM280AXVGGH1EU AM300AXVGGH1EU AM320AXVGGH1EU		80 82 84 86 88 90 92 94 96 98	AM800AXVGGH1EU AM820AXVGGH1EU AM840AXVGGH1EU AM860AXVGGH1EU AM880AXVGGH1EU AM900AXVGGH1EU AM920AXVGGH1EU AM940AXVGGH1EU AM960AXVGGH1EU AM980AXVGGH1EU	
34 36 38 40 42 44 46 48 50 52	AM340AXVGGH1EU AM360AXVGGH1EU AM380AXVGGH1EU AM400AXVGGH1EU AM420AXVGGH1EU AM440AXVGGH1EU AM460AXVGGH1EU AM480AXVGGH1EU AM500AXVGGH1EU AM520AXVGGH1EU				

1. Combination Table

External Appearance

Standard

Capa [HP]	Model Name	Model	Capa [HP]	Model Name	Model
8 10 12 14	AM080AXVAGH/EU AM100AXVAGH/EU AM120AXVAGH/EU AM140AXVAGH/EU		64 66 68 70 72 74 76 78	AM640AXVAGH1EU AM660AXVAGH1EU AM680AXVAGH1EU AM700AXVAGH1EU AM720AXVAGH1EU AM740AXVAGH1EU AM760AXVAGH1EU AM780AXVAGH1EU	
16 18 20 22 24 26	AM160AXVAGH/EU AM180AXVAGH/EU AM200AXVAGH/EU AM220AXVAGH/EU AM240AXVAGH/EU AM260AXVAGH/EU		80 82 84 86	AM800AXVAGH1EU AM820AXVAGH1EU AM840AXVAGH1EU AM860AXVAGH1EU	
28 30 32 34 36 38	AM280AXVAGH1EU AM300AXVAGH1EU AM320AXVAGH1EU AM340AXVAGH1EU AM360AXVAGH1EU AM380AXVAGH1EU				
40 42 44 46 48 50 52	AM400AXVAGH1EU AM420AXVAGH1EU AM440AXVAGH1EU AM460AXVAGH1EU AM480AXVAGH1EU AM500AXVAGH1EU AM520AXVAGH1EU		88 90 92 94 96 98	AM880AXVAGH1EU AM900AXVAGH1EU AM920AXVAGH1EU AM940AXVAGH1EU AM960AXVAGH1EU AM980AXVAGH1EU	
54 56 58 60 62	AM540AXVAGH1EU AM560AXVAGH1EU AM580AXVAGH1EU AM600AXVAGH1EU AM620AXVAGH1EU				

1. Design Procedure & Combination Ratio

Combination Ratio (Connection Ratio)

Definition of Combination Ratio, CR

$$CR = \frac{\text{Sum of Nominal Cooling Capacity of Indoor units}}{\text{Nominal Cooling Capacity of Outdoor unit}} * 100\%$$

Constraints of Allowable Combination Ratio

DVM S systems are normally designed to utilize a CR 50% to 130% to ensure effective load balancing between indoor units and outdoor unit. As buildings have become more insulated, and usage and occupancy of buildings are highly variable, more buildings can realize a higher load balancing between IDUs and ODU, thus higher CR (>130%) is often required. If a system design exceeds 130%, risks associated to increased indoor sound level and reduced comfort levels should be considered. Therefore, when it is necessary to design a combination ratio exceeding 130%, the following conditions must be complied with: -

Design & Selection Procedure

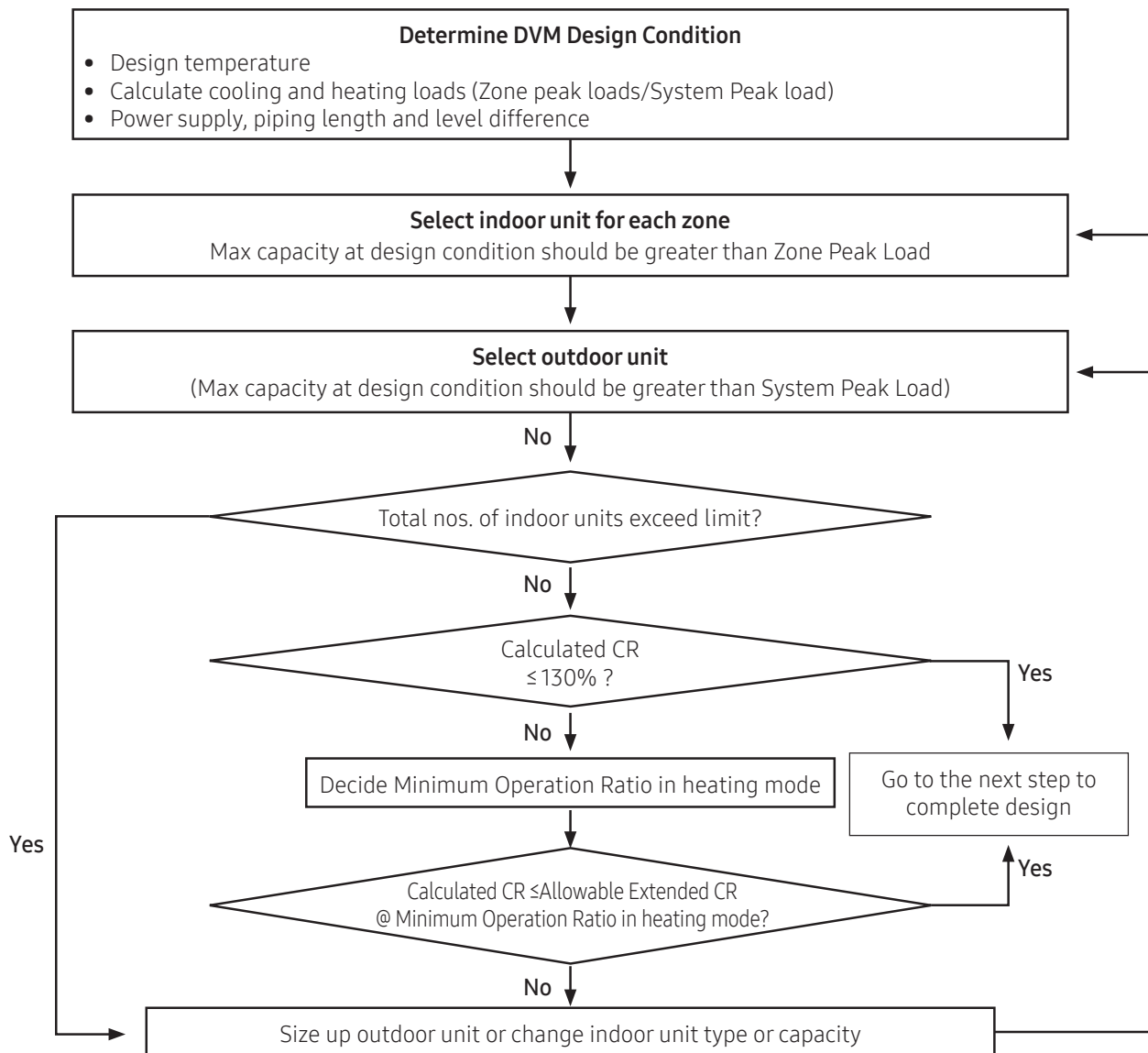

Fig. 1 Design & Selection Procedure for Extended Combination Ratio

1. Design Procedure & Combination Ratio

Combination Ratio (Connection Ratio)

Satisfying cooling & heating comfort

The Maximum Capacity of outdoor unit at design condition calculated from Samsung capacity data table or design tool (DVM Pro) should always be the same or greater than System Peak Load (Block Load) defined in table 1.

Time	Room A	Room B	Room C	Room D	Room E	Room F	Total
	Music Room	Class room	Class room	Class room	Class room	Class room	
09:00	8.4	8.0	8.4	8.0	8.4	8.6	49.8
12:00	9.2	8.8	10.8	8.6	10.8	9.8	58.0
14:00	10.0	9.6	9.6	9.6	11.4	10.8	61.0
16:00	11.0	10.6	8.8	10.8	9.6	9.6	60.4
18:00	9.4	9.0	8.8	9.0	9.0	8.4	53.6

Table 1. Example of System Peak loads

- ▶ Zone Peak Loads (■): To satisfy the demand for each room any time
 - Sum of Zone peak Loads = 65.4kW (11.0 + 10.6 + 10.8 + 10.8 + 11.4 + 10.8)
- ▶ Block load (■): Total peak load at a given time of day.
 - Sum of Zone Peak Loads at 14:00 = 61.0kW



- When a system combination ratio is over 130%, a max system capacity is the same as the published capacity in TDB capacity table at the combination ratio of 130%

Cooling Operation Only

When only cooling operation is used, CR is allowed up to 180% if the Max Capacity of outdoor unit is greater than System Peak Load (Block load) as shown table 2.

Outdoor unit	All capacities of H/P & H/R model
Indoor unit	All indoor unit types
Operation Condition	Cooling mode only
Allowable CR	180%

Table 2. Allowable CR in only cooling operation



- Table 2 shows a standard for allowable CR of cooling only model. Samsung Electronics is not responsible for any problem caused by using a heating mode at the site with a system designed by table 2. If heating operation is required, extended CR design must follow section "Allowable CR limit to avoid abnormal sound level risks in heating operation."

1. Design Procedure & Combination Ratio

Combination Ratio (Connection Ratio)

Allowable CR limit to avoid abnormal sound level risks in heating operation

- ▶ If the CR exceeds 130%, in a specific case of heating operation, an indoor unit may have higher sound level than the level specified in the technical documents.
- ▶ In order to minimize the sound level, the system minimum operation ratio needs to be verified and considered as follows:

※ Operation Ratio(%), OR

- Heat Pump system, H/P

$$OR_{(H/P)} (\%) = \frac{\text{Sum of nominal capacity of indoor units running in heating mode}}{\text{Sum of nominal capacity of indoor units}} * 100\%$$

- Heat Recovery system, H/R

$$OR_{(H/R)} (\%) = \frac{\text{Sum of nominal capacity of indoor units running in both cooling & heating mode}}{\text{Sum of nominal capacity of indoor units}} * 100\%$$

The Minimum Operation Ratio should be determined during the project design stage using Fig. 2.

Outdoor unit	All capacities of H/P & H/R (Single, Dual and Triple Module Systems)		
Indoor unit	All indoor unit types *)except Wall-Mounted		Wall-Mounted
Operation Ratio	Nominal Capacity ≤ 4.5kW	Nominal capacity > 4.5kW	All capacities
10%	131%	145%	135%
20%	137%	153%	141%
30%	149%	162%	151%

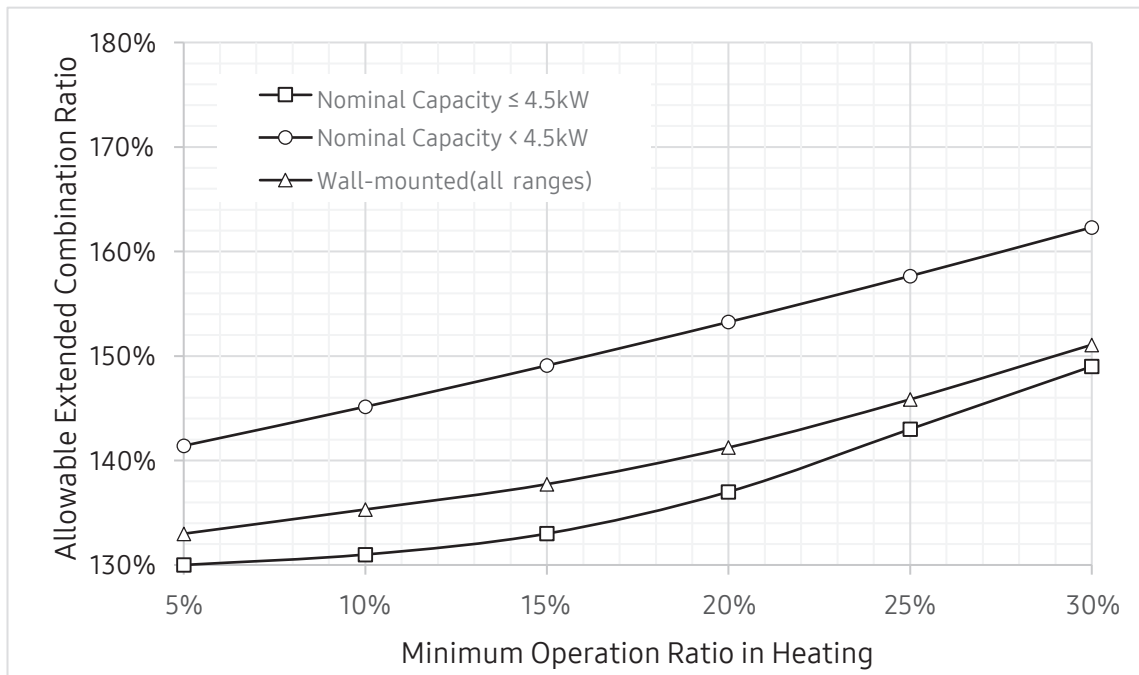

Fig. 2 Allowable CR with respect to indoor unit type as operation ratio increases

1. Design Procedure & Combination Ratio

Combination Ratio (Connection Ratio)

- The minimum operation ratio should be considered during the design stage.
- If a system has a mix of unit types or capacity, the lowest extended connection ratio curve must be utilized.
- In case that a designed Minimum Operation Ratio is less than 5% or more than 30%, the Allowable Extended CR must be considered as the value at 5% and 30%, respectively.
- *If one of following indoor unit types is included in a system, the CR cannot be extended beyond 130%.

Type of indoor unit	Limited by CR130%
1Way Cassette / 4Way Cassette (600 x 600)	2.8kW or below
360 Cassette / Slim Duct (LSP duct)	3.6kW or below
4Way Cassette	5.6kW or below
Floor Standing (Exposed or Concealed)	5.6kW only
Ceiling Suspended	14.0kW only
Hydro unit (HE/HT)	All capacities



NOTE

- Samsung is not responsible for any issue, including abnormal noise that arises during heating operation due solely to the operation rate being lower than the designated combination ratio shown in Fig. 2. Please contact your local Samsung representative for further details if the project requires you to design the project with a connection ratio greater than 130%.

2. Specification

Premium energy efficiency

Model Name				AM080AXVGGH/EU	AM100AXVGGH/EU	AM120AXVGGH/EU
		Outdoor unit module 1		-	-	-
		Outdoor unit module 2		-	-	-
		Outdoor unit module 3		-	-	-
		Outdoor unit module 4		-	-	-
Power Supply			Ø, #, V, Hz	3, 4, 380-415, 50	3, 4, 380-415, 50	3, 4, 380-415, 50
Mode			-	HEAT PUMP	HEAT PUMP	HEAT PUMP
Performance	HP		HP	8	10	12
	Capacity	Cooling(Rated)	kW	22.4	28.0	33.6
		Heating(Rated)	kW	22.4	28.0	33.6
		Heating(Max)	kW	25.2	31.5	37.8
Maximum number of connectable indoor units			EA	14	18	21
Total capacity of the connected Indoor Units		Min.	kW	11.2	14.0	16.8
		Max.	kW	29.1	36.4	43.7
Current	Current Input (Ducted)	Cooling(Rated)	A	11.44	15.97	19.25
		Heating(Rated)	A	9.09	11.41	14.37
	Current Input (Non-Ducted)	Cooling(Rated)	A	9.99	13.84	17.74
		Heating(Rated)	A	8.05	10.83	14.25
	Current	Minimum Ssc	MVA	3.0	3.4	4.0
		MCA	A	18.0	21.2	25.0
MFA		A	25	32	32	
Efficiency	SEER	Ducted	W/W	7.20	6.90	6.90
	SCOP		W/W	4.50	4.40	4.56
	ηs.c		%	285	273	273
	ηs.h		%	177	173	179.4
	SEER	Non_Ducted	W/W	7.78	7.22	7.22
	SCOP		W/W	4.53	4.39	4.41
	ηs.c		%	308.2	285.8	285.8
	ηs.h		%	178.2	172.6	173.4
Pdesignh			kW	14	16.9	19.7
Casing	Material	Body	-	GI Steel Plate	GI Steel Plate	GI Steel Plate
		Base	-	GI Steel Plate	GI Steel Plate	GI Steel Plate
Heat Exchanger	Type		-	Fin & Tube	Fin & Tube	Fin & Tube
	Material	Fin	-	Al	Al	Al
		Tube	-	Cu	Cu	Cu
	Fin Treatment		-	Anti-corrosion	Anti-corrosion	Anti-corrosion
Compressor	Type		-	Inverter Scroll x 1	Inverter Scroll x 1	Inverter Scroll x 1
	Output		kW x n	4.60 x 1	6.67 x 1	6.67 x 1
	Model Name		-	DS2GR7046FV* x 1	DS4GR7066FV* x 1	DS4GR7066FV* x 1
	Oil	Type	-	PVE	PVE	PVE
		Initial charge	cc x n	900 x 1	1,100 x 1	1,100 x 1
Fan	Type		-	Propeller	Propeller	Propeller
	Discharge direction		-	Top	Top	Top
	Quantity		EA	1	1	1
	Air Flow Rate		m³/min	164	181	196
			l/s	2,738	3,019	3,260
	External Static Pressure	Max.	mmAq	11	11	11
			Pa	110	110	110
Fan Motor	Type		-	BLDC Motor	BLDC Motor	BLDC Motor
	Output		W x n	630 x 1	630 x 1	630 x 1
Piping Connections	Liquid Pipe		Type	Braze connection	Braze connection	Braze connection
			Φ, mm (inch)	9.52 (3/8)	9.52 (3/8)	12.70 (1/2)
	Gas Pipe		Type	Braze connection	Braze connection	Braze connection
			Φ, mm (inch)	19.05 (3/4)	22.22 (7/8)	28.58 (1-1/8)
Heat Insulation		-	Both liquid and gas pipes	Both liquid and gas pipes	Both liquid and gas pipes	

2. Specification

Premium energy efficiency

Model Name				AM080AXVGGH/EU	AM100AXVGGH/EU	AM120AXVGGH/EU
Outdoor unit module 1				-	-	-
Outdoor unit module 2				-	-	-
Outdoor unit module 3				-	-	-
Outdoor unit module 4				-	-	-
Piping Connections	Piping length (ODU-IDU)	Max. [Equiv.]	m	200[220]	200[220]	200[220]
	Piping length (1st Branch-IDU)	Max.	m	90	90	90
	Total piping length (System)	Max.	m	1,000	1,000	1,000
	Level difference (ODU in highest position)	Max.	m	110	110	110
	Level difference (IDU in highest position)	Max.	m	110	110	110
	Level difference (IDU-IDU)	Max.	m	50	50	50
Wiring connections	Transmission Cable	Min.	mm ²	0.75	0.75	0.75
		Remark	-	F1, F2	F1, F2	F1, F2
	Power supply intake		-	Both indoor and outdoor unit	Both indoor and outdoor unit	Both indoor and outdoor unit
Refrigerant	Type		-	R410A	R410A	R410A
	Factory Charging		kg	7.0	7.0	7.0
			tCO ₂ e		14.62	14.62
Sound	Sound Pressure	Cooling	dB(A)	53	56	61
		Heating	dB(A)	58	60	63
	Sound Power		dB(A)	75	78	81
External Dimension	Net Weight		kg	194	205	205
	Shipping Weight		kg	208	219	219
	Net Dimensions (WxHxD)		mm	930 x 1,695 x 765	930 x 1,695 x 765	930 x 1,695 x 765
	Shipping Dimensions (WxHxD)		mm	998 x 1,887 x 829	998 x 1,887 x 829	998 x 1,887 x 829
Operating Temp. Range	Cooling		°C	-5 ~ 50	-5 ~ 50	-5 ~ 50
	Heating		°C	-25 ~ 24	-25 ~ 24	-25 ~ 24

NOTE

- Specification may be subject to change without prior notice.
- Specification comply with EN14825 and Eurovent test condition
- 1) Performances are based on the following test conditions.
 - Cooling : Indoor temperature 27°CDB, 19°CWB, Outdoor temperature 35°CDB, 24°CWB
 - Heating : Indoor temperature 20°CDB, 15°CWB, Outdoor temperature 7°CDB, 6°CWB
 - Equivalent refrigerant pipe length 5m, Level differences 0m
 - Refer to EUROVENT website(www.eurovent-certification.com) for other indoor unit combination and more detail test conditions.
- 2) Performance of Multiple Module Outdoor unit is weighted average of Single Module outdoor units.
- 3) Allowed combination ratio of the total rated indoor unit capacity over the rated outdoor unit capacity is 50~130%.
- 4) Sound pressure level is obtained in an anechoic room.
 - Sound pressure level is a relative value, depending on the distance and acoustic environment.
 - Sound pressure level may differ depending on operation condition.
 - dBA = A-weighted sound pressure level
 - Reference acoustic pressure 0 dB = 20uPa
- 5) Sound power level is an absolute value that a sound source generates.
 - dBA = A-weighted sound power level
 - Reference power : 1pW
 - Measured according to ISO 3741
- 6) Sound values of multi combination are theoretical values based on sound results of individual installed units.
- 7) These products contain R410A (GWP=2,088) which is fluorinated greenhouse gas.
- 8) If outdoor unit is located in a higher position than indoor unit, level difference is 110m or under.
 - (If the level difference is higher than 50m, make a decision by PDM kit installation Guide software whether the PDM kit should be installed or not.)
 - PDM kit: Pressure Drop Modulation kit
 - When the outdoor unit is below the indoor unit & the level differences are 40m or more, contact your local dealer for more information.
- 9) In case you want to know more information regarding capacity and correction, please refer to capacity table TDB on pvi.samsung.com site.
- 10) Recommended combination

* Ducted

Capacity	Indoor Units	Capacity	Indoor Units
8HP	AM056ANHPKH×4	18HP	AM056ANHPKH×4 + AM071ANHPKH×4
10HP	AM071ANHPKH×4	20HP	AM071ANHPKH×8
12HP	AM056ANHPKH×6	22HP	AM071ANHPKH×4 + AM090ANHPKH×4
14HP	AM056ANHPKH×1 + AM071ANHPKH×5	24HP	AM071ANHPKH×1 + AM090ANLDKH×7
16HP	AM056ANHPKH×2 + AM090ANHPKH×4	26HP	AM090ANLDKH×6 + AM112ANLDKH×2

* Non-ducted

Capacity	Indoor Units	Capacity	Indoor Units
8HP	AM028AN4PKH + AM056AN4PKH×2 + AM090AN4PKH	18HP	AM028AN4PKH + AM056AN4PKH + AM056AN4PKH + AM056AN4PKH×2 + AM090AN4PKH×2 + AM120AN4PKH
10HP	AM056AN4PKH×2 + AM090AN4PKH×2	20HP	AM028AN4PKH + AM056AN4PKH×2 + AM090AN4PKH×2 + AM120AN4PKH
12HP	AM028AN4PKH×2 + AM056AN4PKH×2 + AM090AN4PKH×2	22HP	AM028AN4PKH + AM056AN4PKH + AM056AN4PKH + AM090AN4PKH×2 + AM120AN4PKH
14HP	AM028AN4PKH + AM056AN4PKH + AM056AN4PKH + AM071AN4PKH + AM090AN4PKH + AM120AN4PKH	24HP	AM028AN4PKH + AM120AN4PKH×2 + AM120AN4PKH×2
16HP	AM028AN4PKH + AM056AN4PKH + AM090AN4PKH×2 + AM120AN4PKH	26HP	AM071AN4PKH + AM120AN4PKH + AM120AN4PKH×2

2. Specification

Premium energy efficiency

Model Name				AM140AXVGGH/EU	AM160AXVGGH/EU	AM180AXVGGH/EU	
Outdoor unit module 1				-	-	-	
Outdoor unit module 2				-	-	-	
Outdoor unit module 3				-	-	-	
Outdoor unit module 4				-	-	-	
Power Supply			Ø, #, V, Hz	3, 4, 380-415, 50	3, 4, 380-415, 50	3, 4, 380-415, 50	
Mode			-	HEAT PUMP	HEAT PUMP	HEAT PUMP	
Performance	HP		HP	14	16	18	
	Capacity	Cooling(Rated)	kW	40.0	45.0	50.4	
		Heating(Rated)	kW	40.0	45.0	50.4	
		Heating(Max)	kW	45.0	50.4	56.7	
Maximum number of connectable indoor units			EA	26	29	32	
Total capacity of the connected Indoor Units			Min.	kW	20.0	22.5	25.2
			Max.	kW	52.0	58.5	65.5
Current	Current Input (Ducted)	Cooling(Rated)	A	25.44	26.96	26.79	
		Heating(Rated)	A	17.06	19.35	21.14	
	Current Input (Non-Ducted)	Cooling(Rated)	A	24.44	24.77	29.19	
		Heating(Rated)	A	17.58	18.98	21.85	
	Current	Minimum Ssc	MVA	4.4	5.2	6.4	
		MCA	A	27.0	32.0	39.2	
MFA		A	32	40	50		
Efficiency	SEER	Ducted	W/W	6.70	6.90	7.50	
			W/W	4.25	4.30	4.80	
			%	265	273	297	
			%	167	169	189	
	SEER	Non_Ducted	W/W	6.94	7.25	7.05	
			W/W	4.35	4.35	4.45	
			%	274.6	287	279	
			%	171	171	175	
	Pdesignh			kW	22.6	25	28.3
Casing	Material	Body	-	GI Steel Plate	GI Steel Plate	GI Steel Plate	
		Base	-	GI Steel Plate	GI Steel Plate	GI Steel Plate	
Heat Exchanger	Type		-	Fin & Tube	Fin & Tube	Fin & Tube	
	Material	Fin	-	Al	Al	Al	
		Tube	-	Cu	Cu	Cu	
	Fin Treatment			-	Anti-corrosion	Anti-corrosion	Anti-corrosion
Compressor	Type		-	Inverter Scroll x 1	Inverter Scroll x 1	Inverter Scroll x 1	
	Output		kW x n	6.67 x 1	8.93 x 1	8.93 x 1	
	Model Name		-	DS4GR7066FV* x 1	DS4GM7090FV* x 1	DS4GM7090FV* x 1	
	Oil	Type	-	PVE	PVE	PVE	
		Initial charge	cc x n	1,100 x 1	1,400 x 1	1,400 x 1	
Fan	Type		-	Propeller	Propeller	Propeller	
	Discharge direction		-	Top	Top	Top	
	Quantity		EA	2	2	2	
	Air Flow Rate		m³/min	291	292	313	
			l/s	4,852	4,866	5,209	
	External Static Pressure	Max.	mmAq	11	11	11	
			Pa	110	110	110	
Fan Motor	Type		-	BLDC Motor	BLDC Motor	BLDC Motor	
	Output		W x n	620 x 2	620 x 2	620 x 2	
Piping Connections	Liquid Pipe		Type	Braze connection	Braze connection	Braze connection	
			Φ, mm (inch)	12.70 (1/2)	12.70 (1/2)	15.88 (5/8)	
	Gas Pipe		Type	Braze connection	Braze connection	Braze connection	
			Φ, mm (inch)	28.58 (1-1/8)	28.58 (1-1/8)	28.58 (1-1/8)	
	Heat Insulation			-	Both liquid and gas pipes	Both liquid and gas pipes	Both liquid and gas pipes

2. Specification

Premium energy efficiency

Model Name				AM140AXVGGH/EU	AM160AXVGGH/EU	AM180AXVGGH/EU
	Outdoor unit module 1			-	-	-
	Outdoor unit module 2			-	-	-
	Outdoor unit module 3			-	-	-
	Outdoor unit module 4			-	-	-
Piping Connections	Piping length (ODU-IDU)	Max. [Equiv.]	m	200[220]	200[220]	200[220]
	Piping length (1st Branch-IDU)	Max.	m	90	90	90
	Total piping length (System)	Max.	m	1,000	1,000	1,000
	Level difference (ODU in highest position)	Max.	m	110	110	110
	Level difference (IDU in highest position)	Max.	m	110	110	110
	Level difference (IDU-IDU)	Max.	m	50	50	50
Wiring connections	Transmission Cable	Min.	mm ²	0.75	0.75	0.75
		Remark	-	F1, F2	F1, F2	F1, F2
	Power supply intake		-	Both indoor and outdoor unit	Both indoor and outdoor unit	Both indoor and outdoor unit
Refrigerant	Type		-	R410A	R410A	R410A
	Factory Charging		kg	8.0	10.5	10.5
				tCO ₂ e	16.70	21.92
Sound	Sound Pressure	Cooling	dB(A)	58	58	59
		Heating	dB(A)	61	61	63
	Sound Power		dB(A)	81	81	81
External Dimension	Net Weight		kg	233	262	268
	Shipping Weight		kg	250	279	285
	Net Dimensions (WxHxD)		mm	1,295 x 1,695 x 765	1,295 x 1,695 x 765	1,295 x 1,695 x 765
	Shipping Dimensions (WxHxD)		mm	1,363 x 1,887 x 829	1,363 x 1,887 x 829	1,363 x 1,887 x 829
Operating Temp. Range	Cooling		°C	-5 ~ 50	-5 ~ 50	-5 ~ 50
	Heating		°C	-25 ~ 24	-25 ~ 24	-25 ~ 24

NOTE

- Specification may be subject to change without prior notice.
 - Specification comply with EN14825 and Eurovent test condition
- 1) Performances are based on the following test conditions.
 - Cooling : Indoor temperature 27°CDB, 19°CWB, Outdoor temperature 35°CDB, 24°CWB
 - Heating : Indoor temperature 20°CDB, 15°CWB, Outdoor temperature 7°CDB, 6°CWB
 - Equivalent refrigerant pipe length 5m, Level differences 0m
 - Refer to EUROVENT website(www.eurovent-certification.com) for other indoor unit combination and more detail test conditions.
 - 2) Performance of Multiple Module Outdoor unit is weighted average of Single Module outdoor units.
 - 3) Allowed combination ratio of the total rated indoor unit capacity over the rated outdoor unit capacity is 50~130%.
 - 4) Sound pressure level is obtained in an anechoic room.
 - Sound pressure level is a relative value, depending on the distance and acoustic environment.
 - Sound pressure level may differ depending on operation condition.
 - dBA = A-weighted sound pressure level
 - Reference acoustic pressure 0 dB = 20uPa
 - 5) Sound power level is an absolute value that a sound source generates.
 - dBA = A-weighted sound power level
 - Reference power : 1pW
 - Measured according to ISO 3741
 - 6) Sound values of multi combination are theoretical values based on sound results of individual installed units.
 - 7) These products contain R410A (GWP=2,088) which is fluorinated greenhouse gas.
 - 8) If outdoor unit is located in a higher position than indoor unit, level difference is 110m or under.
 - (If the level difference is higher than 50m, make a decision by PDM kit installation Guide software whether the PDM kit should be installed or not.)
 - PDM kit: Pressure Drop Modulation kit
 - When the outdoor unit is below the indoor unit & the level differences are 40m or more, contact your local dealer for more information.
 - 9) In case you want to know more information regarding capacity and correction, please refer to capacity table TDB on pvi.samsung.com site.
 - 10) Recommended combination

* Ducted

Capacity	Indoor Units	Capacity	Indoor Units
8HP	AM056ANHPKH×4	18HP	AM056ANHPKH×4 + AM071ANHPKH×4
10HP	AM071ANHPKH×4	20HP	AM071ANHPKH×8
12HP	AM056ANHPKH×6	22HP	AM071ANHPKH×4 + AM090ANHPKH×4
14HP	AM056ANHPKH×1 + AM071ANHPKH×5	24HP	AM071ANHPKH×1 + AM090ANLDKH×7
16HP	AM056ANHPKH×2 + AM090ANHPKH×4	26HP	AM090ANLDKH×6 + AM112ANLDKH×2

* Non-ducted

Capacity	Indoor Units	Capacity	Indoor Units
8HP	AM028AN4PKH + AM056AN4PKH×2 + AM090AN4PKH	18HP	AM028AN4PKH + AM056AN4PKH + AM056AN4PKH + AM056AN4PKH×2 + AM090AN4PKH×2 + AM071AN4PKH
10HP	AM056AN4PKH×2 + AM090AN4PKH×2	20HP	AM028AN4PKH + AM056AN4PKH×2 + AM090AN4PKH×2 + AM090AN4PKH×2 + AM071AN4PKH
12HP	AM028AN4PKH×2 + AM056AN4PKH×2 + AM090AN4PKH×2	22HP	AM028AN4PKH + AM056AN4PKH + AM056AN4PKH + AM090AN4PKH + AM071AN4PKH + AM071AN4PKH + AM071AN4PKH
14HP	AM028AN4PKH + AM056AN4PKH + AM056AN4PKH + AM090AN4PKH + AM071AN4PKH	24HP	AM028AN4PKH + AM056AN4PKH + AM056AN4PKH + AM090AN4PKH×3 + AM071AN4PKH×3
16HP	AM028AN4PKH + AM056AN4PKH + AM090AN4PKH×3 + AM071AN4PKH	26HP	AM071AN4PKH + AM112AN4PKH×2 + AM128AN4PKH×4

2. Specification

Premium energy efficiency

Model Name				AM200AXVGGH/EU	AM220AXVGGH/EU	AM240AXVGGH/EU
Outdoor unit module 1				-	-	-
Outdoor unit module 2				-	-	-
Outdoor unit module 3				-	-	-
Outdoor unit module 4				-	-	-
Power Supply			Ø, #, V, Hz	3, 4, 380-415, 50	3, 4, 380-415, 50	3, 4, 380-415, 50
Mode			-	HEAT PUMP	HEAT PUMP	HEAT PUMP
Performance	HP		HP	20	22	24
	Capacity	Cooling(Rated)	kW	56.0	61.6	67.2
		Heating(Rated)	kW	56.0	61.6	67.2
		Heating(Max)	kW	63.0	69.3	75.6
Maximum number of connectable indoor units			EA	36	40	43
Total capacity of the connected Indoor Units			Min.	kW	28.0	30.8
			Max.	kW	72.8	80.1
Current	Current Input (Ducted)	Cooling(Rated)	A	38.63	44.15	48.62
		Heating(Rated)	A	25.72	27.29	44.20
	Current Input (Non-Ducted)	Cooling(Rated)	A	36.21	38.67	47.27
		Heating(Rated)	A	25.11	26.51	44.20
	Current	Minimum Ssc	MVA	7.0	7.4	9.3
		MCA	A	43.0	46.0	55.0
MFA		A	63	63	63	
Efficiency	SEER	Ducted	W/W	6.50	6.20	5.90
			W/W	4.50	4.30	3.90
			%	257	245	233
			%	177	169	153
	SEER	Non_Ducted	W/W	6.81	7.04	5.94
			W/W	4.27	4.39	3.90
			%	269.4	278.6	234.6
			%	167.8	172.6	153
Pdesignh			kW	31.1	31.8	32.4
Casing	Material	Body	-	GI Steel Plate	GI Steel Plate	GI Steel Plate
		Base	-	GI Steel Plate	GI Steel Plate	GI Steel Plate
Heat Exchanger	Type		-	Fin & Tube	Fin & Tube	Fin & Tube
	Material	Fin	-	Al	Al	Al
		Tube	-	Cu	Cu	Cu
	Fin Treatment		-	Anti-corrosion	Anti-corrosion	Anti-corrosion
Compressor	Type		-	Inverter Scroll x 1	Inverter Scroll x 2	Inverter Scroll x 2
	Output		kW x n	8.93 x 1	6.67 x 2	6.67 x 2
	Model Name		-	DS4GM7090FV* x 1	DS4GR7066FV* x 2	DS4GR7066FV* x 2
	Oil	Type	-	PVE	PVE	PVE
		Initial charge	cc x n	1,400 x 1	1,100 x 2	1,100 x 2
Fan	Type		-	Propeller	Propeller	Propeller
	Discharge direction		-	Top	Top	Top
	Quantity		EA	2	2	2
	Air Flow Rate		m³/min	313	342	365
			l/s	5,209	5,698	6,089
	External Static Pressure	Max.	mmAq	11	11	8
			Pa	110	110	80
Fan Motor	Type		-	BLDC Motor	BLDC Motor	BLDC Motor
	Output		W x n	620 x 2	620 x 2	620 x 2
Piping Connections	Liquid Pipe		Type	Braze connection	Braze connection	Braze connection
			Φ, mm (inch)	15.88 (5/8)	15.88 (5/8)	15.88 (5/8)
	Gas Pipe		Type	Braze connection	Braze connection	Braze connection
			Φ, mm (inch)	28.58 (1-1/8)	28.58 (1-1/8)	34.92 (1-3/8)
	Heat Insulation		-	Both liquid and gas pipes	Both liquid and gas pipes	Both liquid and gas pipes

2. Specification

Premium energy efficiency

Model Name				AM200AXVGGH/EU	AM220AXVGGH/EU	AM240AXVGGH/EU
Outdoor unit module	Outdoor unit module 1			-	-	-
	Outdoor unit module 2			-	-	-
	Outdoor unit module 3			-	-	-
	Outdoor unit module 4			-	-	-
Piping Connections	Piping length (ODU-IDU)	Max. [Equiv.]	m	200[220]	200[220]	200[220]
	Piping length (1st Branch-IDU)	Max.	m	90	90	90
	Total piping length (System)	Max.	m	1,000	1,000	1,000
	Level difference (ODU in highest position)	Max.	m	110	110	110
	Level difference (IDU in highest position)	Max.	m	110	110	110
	Level difference (IDU-IDU)	Max.	m	50	50	50
Wiring connections	Transmission Cable	Min.	mm ²	0.75	0.75	0.75
		Remark	-	F1, F2	F1, F2	F1, F2
	Power supply intake		-	Both indoor and outdoor unit	Both indoor and outdoor unit	Both indoor and outdoor unit
Refrigerant	Type		-	R410A	R410A	R410A
	Factory Charging		kg	10.5	10.5	14.0
			tCO ₂ e		21.92	21.92
Sound	Sound Pressure	Cooling	dB(A)	61	64	65
		Heating	dB(A)	63	65	67
	Sound Power		dB(A)	84	86	87
External Dimension	Net Weight		kg	268	301	325
	Shipping Weight		kg	285	318	342
	Net Dimensions (WxHxD)		mm	1,295 x 1,695 x 765	1,295 x 1,695 x 765	1,295 x 1,695 x 765
	Shipping Dimensions (WxHxD)		mm	1,363 x 1,887 x 829	1,363 x 1,887 x 829	1,363 x 1,887 x 829
Operating Temp. Range	Cooling		°C	-5 ~ 50	-5 ~ 50	-5 ~ 50
	Heating		°C	-25 ~ 24	-25 ~ 24	-25 ~ 24

NOTE

- Specification may be subject to change without prior notice.
- Specification comply with EN14825 and Eurovent test condition
- 1) Performances are based on the following test conditions.
 - Cooling : Indoor temperature 27°CDB, 19°CWB, Outdoor temperature 35°CDB, 24°CWB
 - Heating : Indoor temperature 20°CDB, 15°CWB, Outdoor temperature 7°CDB, 6°CWB
 - Equivalent refrigerant pipe length 5m, Level differences 0m
 - Refer to EUROVENT website(www.eurovent-certification.com) for other indoor unit combination and more detail test conditions.
- 2) Performance of Multiple Module Outdoor unit is weighted average of Single Module outdoor units.
- 3) Allowed combination ratio of the total rated indoor unit capacity over the rated outdoor unit capacity is 50~130%.
- 4) Sound pressure level is obtained in an anechoic room.
 - Sound pressure level is a relative value, depending on the distance and acoustic environment.
 - Sound pressure level may differ depending on operation condition.
 - dBA = A-weighted sound pressure level
 - Reference acoustic pressure 0 dB = 20uPa
- 5) Sound power level is an absolute value that a sound source generates.
 - dBA = A-weighted sound power level
 - Reference power : 1pW
 - Measured according to ISO 3741
- 6) Sound values of multi combination are theoretical values based on sound results of individual installed units.
- 7) These products contain R410A (GWP=2,088) which is fluorinated greenhouse gas.
- 8) If outdoor unit is located in a higher position than indoor unit, level difference is 110m or under.
 - (If the level difference is higher than 50m, make a decision by PDM kit installation Guide software whether the PDM kit should be installed or not.)
 - PDM kit: Pressure Drop Modulation kit
 - When the outdoor unit is below the indoor unit & the level differences are 40m or more, contact your local dealer for more information.
- 9) In case you want to know more information regarding capacity and correction, please refer to capacity table TDB on pvi.samsung.com site.
- 10) Recommended combination

* Ducted

Capacity	Indoor Units	Capacity	Indoor Units
8HP	AM056ANHPKH×4	18HP	AM056ANHPKH×4 + AM071ANHPKH×4
10HP	AM071ANHPKH×4	20HP	AM071ANHPKH×8
12HP	AM056ANHPKH×6	22HP	AM071ANHPKH×4 + AM090ANHPKH×4
14HP	AM056ANHPKH×1 + AM071ANHPKH×5	24HP	AM071ANHPKH×1 + AM090ANLDKH×7
16HP	AM056ANHPKH×2 + AM090ANHPKH×4	26HP	AM090ANLDKH×6 + AM112ANLDKH×2

* Non-ducted

Capacity	Indoor Units	Capacity	Indoor Units
8HP	AM028AN4PKH + AM056AN4PKH×2 + AM090AN4PKH	18HP	AM028AN4PKH + AM056AN4PKH + AM056AN4PKH + AM056AN4PKH×2 + AM090AN4PKH×2 + AM128AN4PKH
10HP	AM056AN4PKH×2 + AM090AN4PKH×2	20HP	AM028AN4PKH + AM056AN4PKH×2 + AM090AN4PKH×2 + AM128AN4PKH
12HP	AM028AN4PKH×2 + AM056AN4PKH×2 + AM090AN4PKH×2	22HP	AM028AN4PKH + AM056AN4PKH + AM056AN4PKH + AM090AN4PKH + AM128AN4PKH
14HP	AM028AN4PKH + AM056AN4PKH + AM056AN4PKH + AM090AN4PKH + AM128AN4PKH	24HP	AM071AN4PKH + AM128AN4PKH×2 + AM128AN4PKH×3
16HP	AM028AN4PKH + AM056AN4PKH + AM090AN4PKH×3 + AM128AN4PKH	26HP	AM071AN4PKH + AM128AN4PKH + AM128AN4PKH×4

2. Specification

Premium energy efficiency

Model Name				AM260AXVGGH/EU	AM280AXVGGH1EU	AM300AXVGGH1EU
Outdoor unit module 1				-	AM100AXVGGH/EU	AM120AXVGGH/EU
Outdoor unit module 2				-	AM180AXVGGH/EU	AM180AXVGGH/EU
Outdoor unit module 3				-	-	-
Outdoor unit module 4				-	-	-
Power Supply			Ø, #, V, Hz	3, 4, 380-415, 50	3, 4, 380-415, 50	3, 4, 380-415, 50
Mode			-	HEAT PUMP	HEAT PUMP	HEAT PUMP
Performance	HP		HP	26	28	30
	Capacity	Cooling(Rated)	kW	72.8	78.4	84.0
		Heating(Rated)	kW	68.0	78.4	84.0
		Heating(Max)	kW	81.9	88.2	94.5
Maximum number of connectable indoor units			EA	47	51	54
Total capacity of the connected Indoor Units			Min.	kW	36.4	42.0
			Max.	kW	94.6	101.9
Current	Current Input (Ducted)	Cooling(Rated)	A	57.61	42.76	46.04
		Heating(Rated)	A	45.11	32.55	35.51
	Current Input (Non-Ducted)	Cooling(Rated)	A	57.61	43.03	50.05
		Heating(Rated)	A	45.11	32.68	35.94
	Current	Minimum Ssc	MVA	10.2	9.8	10.4
		MCA	A	60.0	60.4	64.2
MFA		A	75	75	75	
Efficiency	SEER	Ducted	W/W	5.40	-	-
	SCOP		W/W	3.90	-	-
	igs.c		%	213	-	-
	igs.h		%	153	-	-
	SEER	Non_Ducted	W/W	5.45	-	-
	SCOP		W/W	3.90	-	-
	igs.c		%	215	-	-
	igs.h		%	153	-	-
Pdesignh			kW	33	45.2	48
Casing	Material	Body	-	GI Steel Plate	GI Steel Plate	GI Steel Plate
		Base	-	GI Steel Plate	GI Steel Plate	GI Steel Plate
Heat Exchanger	Type		-	Fin & Tube	Fin & Tube	Fin & Tube
	Material	Fin	-	Al	Al	Al
		Tube	-	Cu	Cu	Cu
	Fin Treatment		-	Anti-corrosion	Anti-corrosion	Anti-corrosion
Compressor	Type		-	Inverter Scroll x 2	Inverter Scroll x 2	Inverter Scroll x 2
	Output		kW x n	6.67 x 2	(6.67 x 1) x 1 + (8.93 x 1) x 1	(6.67 x 1) x 1 + (8.93 x 1) x 1
	Model Name		-	DS4GR7066FV* x 2	(DS4GR7066FV* x 1) x 1 + (DS4GM7090FV* x 1) x 1	(DS4GR7066FV* x 1) x 1 + (DS4GM7090FV* x 1) x 1
	Oil	Type	-	PVE	PVE	PVE
		Initial charge	cc x n	1,100 x 2	(1,100 x 1) x 1 + (1,400 x 1) x 1	(1,100 x 1) x 1 + (1,400 x 1) x 1
Fan	Type		-	Propeller	Propeller	Propeller
	Discharge direction		-	Top	Top	Top
	Quantity		EA	2	3	3
	Air Flow Rate		m³/min	365	181 x 1 + 313 x 1	196 x 1 + 313 x 1
			l/s	6,089	3,019 x 1 + 5,209 x 1	3,260 x 1 + 5,209 x 1
	External Static Pressure	Max.	mmAq	8	11	11
			Pa	80	110	110
Fan Motor	Type		-	BLDC Motor	BLDC Motor	BLDC Motor
	Output		W x n	620 x 2	(630 x 1) x 1 + (620 x 2) x 1	(630 x 1) x 1 + (620 x 2) x 1
Piping Connections	Liquid Pipe		Type	Braze connection	Braze connection	Braze connection
			Φ, mm (inch)	19.05 (3/4)	19.05 (3/4)	19.05 (3/4)
	Gas Pipe		Type	Braze connection	Braze connection	Braze connection
			Φ, mm (inch)	34.92 (1-3/8)	34.92 (1-3/8)	34.92 (1-3/8)
	Heat Insulation		-	Both liquid and gas pipes	Both liquid and gas pipes	Both liquid and gas pipes

2. Specification

Premium energy efficiency

Model Name				AM260AXVGGH/EU	AM280AXVGGH1EU	AM300AXVGGH1EU
Outdoor unit module 1				-	AM100AXVGGH/EU	AM120AXVGGH/EU
Outdoor unit module 2				-	AM180AXVGGH/EU	AM180AXVGGH/EU
Outdoor unit module 3				-	-	-
Outdoor unit module 4				-	-	-
Piping Connections	Piping length (ODU-IDU)	Max. [Equiv.]	m	200[220]	200[220]	200[220]
	Piping length (1st Branch-IDU)	Max.	m	90	90	90
	Total piping length (System)	Max.	m	1,000	1,000	1,000
	Level difference (ODU in highest position)	Max.	m	110	110	110
	Level difference (IDU in highest position)	Max.	m	110	110	110
	Level difference (IDU-IDU)	Max.	m	50	50	50
Wiring connections	Transmission Cable	Min.	mm ²	0.75	0.75	0.75
		Remark	-	F1, F2	F1, F2	F1, F2
	Power supply intake		-	Both indoor and outdoor unit	Both indoor and outdoor unit	Both indoor and outdoor unit
Refrigerant	Type		-	R410A	R410A	R410A
	Factory Charging		kg	14.0	7.0 x 1 + 10.5 x 1	7.0 x 1 + 10.5 x 1
			tCO ₂ e		29.23	36.54
Sound [□]	Sound Pressure	Cooling	dB(A)	65	61	63
		Heating	dB(A)	67	65	66
	Sound Power		dB(A)	87	83	84
External Dimension	Net Weight		kg	325	205 x 1 + 268 x 1	205 x 1 + 268 x 1
	Shipping Weight		kg	342	219 x 1 + 285 x 1	219 x 1 + 285 x 1
	Net Dimensions (WxHxD)		mm	1,295 x 1,695 x 765	(930 x 1,695 x 765) x 1 + (1,295 x 1,695 x 765) x 1	(930 x 1,695 x 765) x 1 + (1,295 x 1,695 x 765) x 1
	Shipping Dimensions (WxHxD)		mm	1,363 x 1,887 x 829	(998 x 1,887 x 829) x 1 + (1,363 x 1,887 x 829) x 1	(998 x 1,887 x 829) x 1 + (1,363 x 1,887 x 829) x 1
Operating Temp. Range	Cooling		°C	-5 ~ 50	-5 ~ 50	-5 ~ 50
	Heating		°C	-25 ~ 24	-25 ~ 24	-25 ~ 24

NOTE

- Specification may be subject to change without prior notice.
- Specification comply with EN14825 and Eurovent test condition
- 1) Performances are based on the following test conditions.
 - Cooling : Indoor temperature 27°CDB, 19°CWB, Outdoor temperature 35°CDB, 24°CWB
 - Heating : Indoor temperature 20°CDB, 15°CWB, Outdoor temperature 7°CDB, 6°CWB
 - Equivalent refrigerant pipe length 5m, Level differences 0m
 - Refer to EUROVENT website(www.eurovent-certification.com) for other indoor unit combination and more detail test conditions.
- 2) Performance of Multiple Module Outdoor unit is weighted average of Single Module outdoor units.
- 3) Allowed combination ratio of the total rated indoor unit capacity over the rated outdoor unit capacity is 50~130%.
- 4) Sound pressure level is obtained in an anechoic room.
 - Sound pressure level is a relative value, depending on the distance and acoustic environment.
 - Sound pressure level may differ depending on operation condition.
 - dBA = A-weighted sound pressure level
 - Reference acoustic pressure 0 dB = 20uPa
- 5) Sound power level is an absolute value that a sound source generates.
 - dBA = A-weighted sound power level
 - Reference power : 1pW
 - Measured according to ISO 3741
- 6) Sound values of multi combination are theoretical values based on sound results of individual installed units.
- 7) These products contain R410A (GWP=2,088) which is fluorinated greenhouse gas.
- 8) If outdoor unit is located in a higher position than indoor unit, level difference is 110m or under.
 - (If the level difference is higher than 50m, make a decision by PDM kit installation Guide software whether the PDM kit should be installed or not.)
 - PDM kit: Pressure Drop Modulation kit
 - When the outdoor unit is below the indoor unit & the level differences are 40m or more, contact your local dealer for more information.
- 9) In case you want to know more information regarding capacity and correction, please refer to capacity table TDB on pvi.samsung.com site.
- 10) Recommended combination

* Ducted

Capacity	Indoor Units	Capacity	Indoor Units
8HP	AM056ANHPKH×4	18HP	AM056ANHPKH×4 + AM071ANHPKH×4
10HP	AM071ANHPKH×4	20HP	AM071ANHPKH×8
12HP	AM056ANHPKH×6	22HP	AM071ANHPKH×4 + AM090ANHPKH×4
14HP	AM056ANHPKH×1 + AM071ANHPKH×5	24HP	AM071ANHPKH×1 + AM090ANLDKH×7
16HP	AM056ANHPKH×2 + AM090ANHPKH×4	26HP	AM090ANLDKH×6 + AM112ANLDKH×2

* Non-ducted

Capacity	Indoor Units	Capacity	Indoor Units
8HP	AM028AN4PKH + AM056AN4PKH×2 + AM090AN4PKH	18HP	AM028AN4PKH + AM056AN4PKH + AM056AN4PKH + AM056AN4PKH×2 + AM090AN4PKH×2 + AM128AN4PKH
10HP	AM056AN4PKH×2 + AM090AN4PKH×2	20HP	AM028AN4PKH + AM056AN4PKH×2 + AM090AN4PKH×2 + AM128AN4PKH
12HP	AM028AN4PKH×2 + AM056AN4PKH×2 + AM090AN4PKH×2	22HP	AM028AN4PKH + AM056AN4PKH + AM056AN4PKH + AM090AN4PKH×2 + AM128AN4PKH×2
14HP	AM028AN4PKH + AM056AN4PKH + AM056AN4PKH + AM071AN4PKH + AM090AN4PKH + AM128AN4PKH	24HP	AM071AN4PKH + AM128AN4PKH×2 + AM128AN4PKH×3
16HP	AM028AN4PKH + AM056AN4PKH + AM090AN4PKH×2 + AM128AN4PKH	26HP	AM071AN4PKH + AM128AN4PKH + AM128AN4PKH×4

2. Specification

Premium energy efficiency

Model Name				AM320AXVGGH1EU	AM340AXVGGH1EU	AM360AXVGGH1EU
			Outdoor unit module 1	AM120AXVGGH/EU	AM160AXVGGH/EU	AM180AXVGGH/EU
			Outdoor unit module 2	AM200AXVGGH/EU	AM180AXVGGH/EU	AM180AXVGGH/EU
			Outdoor unit module 3	-	-	-
Outdoor unit module 4			-	-	-	-
Power Supply			Ø, #, V, Hz	3, 4, 380-415, 50	3, 4, 380-415, 50	3, 4, 380-415, 50
Mode			-	HEAT PUMP	HEAT PUMP	HEAT PUMP
Performance	HP		HP	32	34	36
	Capacity	Cooling(Rated)	kW	89.6	95.4	100.8
		Heating(Rated)	kW	89.6	95.4	100.8
		Heating(Max)	kW	100.8	107.1	113.4
Maximum number of connectable indoor units			EA	58	61	64
Total capacity of the connected Indoor Units			Min.	kW	44.8	47.7
			Max.	kW	116.5	124.0
Current	Current Input (Ducted)	Cooling(Rated)	A	57.88	53.75	53.58
		Heating(Rated)	A	40.09	40.49	42.28
	Current Input (Non-Ducted)	Cooling(Rated)	A	57.26	61.11	71.45
		Heating(Rated)	A	52.25	55.03	55.94
	Current	Minimum Ssc	MVA	11.0	11.6	12.8
		MCA	A	68.0	71.2	78.4
MFA		A	75	80	90	
Efficiency	SEER	Ducted	W/W	-	-	-
	SCOP		W/W	-	-	-
	igs.c		%	-	-	-
	igs.h		%	-	-	-
	SEER	Non_Ducted	W/W	-	-	-
	SCOP		W/W	-	-	-
	igs.c		%	-	-	-
	igs.h		%	-	-	-
Pdesignh			kW	50.8	53.3	56.6
Casing	Material	Body	-	GI Steel Plate	GI Steel Plate	GI Steel Plate
		Base	-	GI Steel Plate	GI Steel Plate	GI Steel Plate
Heat Exchanger	Type		-	Fin & Tube	Fin & Tube	Fin & Tube
	Material	Fin	-	Al	Al	Al
		Tube	-	Cu	Cu	Cu
	Fin Treatment		-	Anti-corrosion	Anti-corrosion	Anti-corrosion
Compressor	Type		-	Inverter Scroll x 2	Inverter Scroll x 2	Inverter Scroll x 2
	Output		kW x n	(6.67 x 1) x 1 + (8.93 x 1) x 1	(8.93 x 1) x 2	(8.93 x 1) x 2
	Model Name		-	(DS4GR7066FV* x 1) x 1 + (DS4GM7090FV* x 1) x 1	(DS4GM7090FV* x 1) x 2	(DS4GM7090FV* x 1) x 2
	Oil	Type	-	PVE	PVE	PVE
Initial charge		cc x n	(1,100 x 1) x 1 + (1,400 x 1) x 1	(1,400 x 1) x 2	(1,400 x 1) x 2	
Fan	Type		-	Propeller	Propeller	Propeller
	Discharge direction		-	Top	Top	Top
	Quantity		EA	3	4	4
	Air Flow Rate		m ³ /min	196 x 1 + 313 x 1	292 x 1 + 313 x 1	313 x 2
			l/s	3,260 x 1 + 5,209 x 1	4,866 x 1 + 5,209 x 1	5,209 x 2
	External Static Pressure	Max.	mmAq	11	11	11
Pa			110	110	110	
Fan Motor	Type		-	BLDC Motor	BLDC Motor	BLDC Motor
	Output		W x n	(630 x 1) x 1 + (620 x 2) x 1	(620 x 2) x 2	(620 x 2) x 2
Piping Connections	Liquid Pipe		Type	Braze connection	Braze connection	Braze connection
			Φ, mm (inch)	19.05 (3/4)	19.05 (3/4)	19.05 (3/4)
	Gas Pipe		Type	Braze connection	Braze connection	Braze connection
			Φ, mm (inch)	34.92 (1-3/8)	34.92 (1-3/8)	41.28 (1-5/8)
Heat Insulation		-	Both liquid and gas pipes	Both liquid and gas pipes	Both liquid and gas pipes	

2. Specification

Premium energy efficiency

Model Name				AM320AXVGGH1EU	AM340AXVGGH1EU	AM360AXVGGH1EU
	Outdoor unit module 1			AM120AXVGGH/EU	AM160AXVGGH/EU	AM180AXVGGH/EU
	Outdoor unit module 2			AM200AXVGGH/EU	AM180AXVGGH/EU	AM180AXVGGH/EU
	Outdoor unit module 3			-	-	-
Outdoor unit module 4			-	-	-	
Piping Connections	Piping length (ODU-IDU)	Max. [Equiv.]	m	200[220]	200[220]	200[220]
	Piping length (1st Branch-IDU)	Max.	m	90	90	90
	Total piping length (System)	Max.	m	1,000	1,000	1,000
	Level difference (ODU in highest position)	Max.	m	110	110	110
	Level difference (IDU in highest position)	Max.	m	110	110	110
	Level difference (IDU-IDU)	Max.	m	50	50	50
Wiring connections	Transmission Cable	Min.	mm ²	0.75	0.75	0.75
		Remark	-	F1, F2	F1, F2	F1, F2
	Power supply intake		-	Both indoor and outdoor unit	Both indoor and outdoor unit	Both indoor and outdoor unit
Refrigerant	Type		-	R410A	R410A	R410A
	Factory Charging		kg	7.0 x 1 + 10.5 x 1	10.5 x 2	10.5 x 2
			tCO ₂ e		36.54	43.85
Sound [□]	Sound Pressure	Cooling	dB(A)	64	62	62
		Heating	dB(A)	66	65	66
	Sound Power		dB(A)	86	84	84
External Dimension	Net Weight		kg	205 x 1 + 268 x 1	262 x 1 + 268 x 1	268 x 2
	Shipping Weight		kg	219 x 1 + 285 x 1	279 x 1 + 285 x 1	285 x 2
	Net Dimensions (WxHxD)		mm	(930 x 1,695 x 765) x 1 + (1,295 x 1,695 x 765) x 1	(1,295 x 1,695 x 765) x 2	(1,295 x 1,695 x 765) x 2
	Shipping Dimensions (WxHxD)		mm	(998 x 1,887 x 829) x 1 + (1,363 x 1,887 x 829) x 1	(1,363 x 1,887 x 829) x 2	(1,363 x 1,887 x 829) x 2
Operating Temp. Range	Cooling		°C	-5 ~ 50	-5 ~ 50	-5 ~ 50
	Heating		°C	-25 ~ 24	-25 ~ 24	-25 ~ 24

NOTE

- Specification may be subject to change without prior notice.
- Specification comply with EN14825 and Eurovent test condition
- 1) Performances are based on the following test conditions.
 - Cooling : Indoor temperature 27°CDB, 19°CWB, Outdoor temperature 35°CDB, 24°CWB
 - Heating : Indoor temperature 20°CDB, 15°CWB, Outdoor temperature 7°CDB, 6°CWB
 - Equivalent refrigerant pipe length 5m, Level differences 0m
 - Refer to EUROVENT website(www.eurovent-certification.com) for other indoor unit combination and more detail test conditions.
- 2) Performance of Multiple Module Outdoor unit is weighted average of Single Module outdoor units.
- 3) Allowed combination ratio of the total rated indoor unit capacity over the rated outdoor unit capacity is 50~130%.
- 4) Sound pressure level is obtained in an anechoic room.
 - Sound pressure level is a relative value, depending on the distance and acoustic environment.
 - Sound pressure level may differ depending on operation condition.
 - dBA = A-weighted sound pressure level
 - Reference acoustic pressure 0 dB = 20uPa
- 5) Sound power level is an absolute value that a sound source generates.
 - dBA = A-weighted sound power level
 - Reference power : 1pW
 - Measured according to ISO 3741
- 6) Sound values of multi combination are theoretical values based on sound results of individual installed units.
- 7) These products contain R410A (GWP=2,088) which is fluorinated greenhouse gas.
- 8) If outdoor unit is located in a higher position than indoor unit, level difference is 110m or under.
 - (If the level difference is higher than 50m, make a decision by PDM kit installation Guide software whether the PDM kit should be installed or not.)
 - PDM kit: Pressure Drop Modulation kit
 - When the outdoor unit is below the indoor unit & the level differences are 40m or more, contact your local dealer for more information.
- 9) In case you want to know more information regarding capacity and correction, please refer to capacity table TDB on pvi.samsung.com site.
- 10) Recommended combination

* Ducted

Capacity	Indoor Units	Capacity	Indoor Units
8HP	AM056ANHPKH×4	18HP	AM056ANHPKH×4 + AM071ANHPKH×4
10HP	AM071ANHPKH×4	20HP	AM071ANHPKH×8
12HP	AM056ANHPKH×6	22HP	AM071ANHPKH×4 + AM090ANHPKH×4
14HP	AM056ANHPKH×1 + AM071ANHPKH×5	24HP	AM071ANHPKH×1 + AM090ANLDKH×7
16HP	AM056ANHPKH×2 + AM090ANHPKH×4	26HP	AM090ANLDKH×6 + AM112ANLDKH×2

* Non-ducted

Capacity	Indoor Units	Capacity	Indoor Units
8HP	AM028AN4PKH + AM056AN4PKH×2 + AM090AN4PKH	18HP	AM028AN4PKH + AM056AN4PKH + AM056AN4PKH + AM056AN4PKH×2 + AM090AN4PKH×2 + AM128AN4PKH
10HP	AM056AN4PKH×2 + AM090AN4PKH×2	20HP	AM028AN4PKH + AM056AN4PKH + AM056AN4PKH + AM056AN4PKH×2 + AM090AN4PKH×2 + AM128AN4PKH
12HP	AM028AN4PKH×2 + AM056AN4PKH×2 + AM090AN4PKH×2	22HP	AM028AN4PKH + AM056AN4PKH + AM056AN4PKH + AM056AN4PKH×2 + AM090AN4PKH×2 + AM128AN4PKH
14HP	AM028AN4PKH + AM056AN4PKH + AM056AN4PKH + AM071AN4PKH + AM090AN4PKH + AM128AN4PKH	24HP	AM028AN4PKH + AM128AN4PKH×2 + AM128AN4PKH×3
16HP	AM028AN4PKH + AM056AN4PKH + AM090AN4PKH×3 + AM128AN4PKH	26HP	AM071AN4PKH + AM128AN4PKH + AM128AN4PKH×4

2. Specification

Premium energy efficiency

Model Name				AM380AXVGGH1EU	AM400AXVGGH1EU	AM420AXVGGH1EU
			Outdoor unit module 1	AM180AXVGGH/EU	AM200AXVGGH/EU	AM200AXVGGH/EU
			Outdoor unit module 2	AM200AXVGGH/EU	AM200AXVGGH/EU	AM220AXVGGH/EU
			Outdoor unit module 3	-	-	-
Outdoor unit module 4			-	-	-	-
Power Supply			Ø, #, V, Hz	3, 4, 380-415, 50	3, 4, 380-415, 50	3, 4, 380-415, 50
Mode			-	HEAT PUMP	HEAT PUMP	HEAT PUMP
Performance	HP		HP	38	40	42
	Capacity	Cooling(Rated)	kW	106.4	112.0	117.6
		Heating(Rated)	kW	106.4	112.0	117.6
		Heating(Max)	kW	119.7	126.0	132.3
Maximum number of connectable indoor units			EA	64	64	64
Total capacity of the connected Indoor Units			Min.	kW	53.2	56.0
			Max.	kW	138.3	145.6
Current	Current Input (Ducted)	Cooling(Rated)	A	65.42	77.26	82.78
		Heating(Rated)	A	46.86	51.44	53.01
	Current Input (Non-Ducted)	Cooling(Rated)	A	75.35	72.42	76.46
		Heating(Rated)	A	59.36	50.22	66.05
	Current	Minimum Ssc	MVA	13.4	14.0	14.4
		MCA	A	82.2	86.0	89.0
MFA		A	90	100	100	
Efficiency	SEER	Ducted	W/W	-	-	-
	SCOP		W/W	-	-	-
	ηs.c		%	-	-	-
	ηs.h		%	-	-	-
	SEER	Non_Ducted	W/W	-	-	-
	SCOP		W/W	-	-	-
	ηs.c		%	-	-	-
	ηs.h		%	-	-	-
	Pdesignh		kW	59.4	62.2	62.9
Casing	Material	Body	-	GI Steel Plate	GI Steel Plate	GI Steel Plate
		Base	-	GI Steel Plate	GI Steel Plate	GI Steel Plate
Heat Exchanger	Type		-	Fin & Tube	Fin & Tube	Fin & Tube
	Material	Fin	-	Al	Al	Al
		Tube	-	Cu	Cu	Cu
	Fin Treatment		-	Anti-corrosion	Anti-corrosion	Anti-corrosion
Compressor	Type		-	Inverter Scroll x 2	Inverter Scroll x 2	Inverter Scroll x 3
	Output		kW x n	(8.93 x 1) x 2	(8.93 x 1) x 2	(8.93 x 1) x 1 + (6.67 x 2) x 1
	Model Name		-	(DS4GM7090FV* x 1) x 2	(DS4GM7090FV* x 1) x 2	(DS4GM7090FV* x 1) x 1 + (DS4GR7066FV* x 2) x 1
	Oil	Type	-	PVE	PVE	PVE
		Initial charge	cc x n	(1,400 x 1) x 2	(1,400 x 1) x 2	(1,400 x 1) x 1 + (1,100 x 2) x 1
Fan	Type		-	Propeller	Propeller	Propeller
	Discharge direction		-	Top	Top	Top
	Quantity		EA	4	4	4
	Air Flow Rate		m³/min	313 x 2	313 x 2	313 x 1 + 342 x 1
			l/s	5,209 x 2	5,209 x 2	5,209 x 1 + 5,698 x 1
	External Static Pressure	Max.	mmAq	11	11	11
			Pa	110	110	110
Fan Motor	Type		-	BLDC Motor	BLDC Motor	BLDC Motor
	Output		W x n	(620 x 2) x 2	(620 x 2) x 2	(620 x 2) x 2
Piping Connections	Liquid Pipe		Type	Braze connection	Braze connection	Braze connection
			Φ, mm (inch)	19.05 (3/4)	19.05 (3/4)	19.05 (3/4)
	Gas Pipe		Type	Braze connection	Braze connection	Braze connection
			Φ, mm (inch)	41.28 (1-5/8)	41.28 (1-5/8)	41.28 (1-5/8)
Heat Insulation		-	Both liquid and gas pipes	Both liquid and gas pipes	Both liquid and gas pipes	

2. Specification

Premium energy efficiency

Model Name				AM380AXVGGH1EU	AM400AXVGGH1EU	AM420AXVGGH1EU
	Outdoor unit module 1			AM180AXVGGH/EU	AM200AXVGGH/EU	AM200AXVGGH/EU
	Outdoor unit module 2			AM200AXVGGH/EU	AM200AXVGGH/EU	AM220AXVGGH/EU
	Outdoor unit module 3			-	-	-
Outdoor unit module 4			-	-	-	
Piping Connections	Piping length (ODU-IDU)	Max. [Equiv.]	m	200[220]	200[220]	200[220]
	Piping length (1st Branch-IDU)	Max.	m	90	90	90
	Total piping length (System)	Max.	m	1,000	1,000	1,000
	Level difference (ODU in highest position)	Max.	m	110	110	110
	Level difference (IDU in highest position)	Max.	m	110	110	110
	Level difference (IDU-IDU)	Max.	m	50	50	50
Wiring connections	Transmission Cable	Min.	mm ²	0.75	0.75	0.75
		Remark	-	F1, F2	F1, F2	F1, F2
	Power supply intake		-	Both indoor and outdoor unit	Both indoor and outdoor unit	Both indoor and outdoor unit
Refrigerant	Type		-	R410A	R410A	R410A
	Factory Charging		kg	10.5 x 2	10.5 x 2	10.5 x 2
			tCO ₂ e		43.85	43.85
Sound	Sound Pressure	Cooling	dB(A)	63	64	66
		Heating	dB(A)	66	66	67
	Sound Power		dB(A)	86	87	88
External Dimension	Net Weight		kg	268 x 2	268 x 2	268 x 1 + 301 x 1
	Shipping Weight		kg	285 x 2	285 x 2	285 x 1 + 318 x 1
	Net Dimensions (WxHxD)		mm	(1,295 x 1,695 x 765) x 2	(1,295 x 1,695 x 765) x 2	(1,295 x 1,695 x 765) x 2
	Shipping Dimensions (WxHxD)		mm	(1,363 x 1,887 x 829) x 2	(1,363 x 1,887 x 829) x 2	(1,363 x 1,887 x 829) x 2
Operating Temp. Range	Cooling		°C	-5 ~ 50	-5 ~ 50	-5 ~ 50
	Heating		°C	-25 ~ 24	-25 ~ 24	-25 ~ 24

NOTE

- Specification may be subject to change without prior notice.
 - Specification comply with EN14825 and Eurovent test condition
- 1) Performances are based on the following test conditions.
 - Cooling : Indoor temperature 27°CDB, 19°CWB, Outdoor temperature 35°CDB, 24°CWB
 - Heating : Indoor temperature 20°CDB, 15°CWB, Outdoor temperature 7°CDB, 6°CWB
 - Equivalent refrigerant pipe length 5m, Level differences 0m
 - Refer to EUROVENT website(www.eurovent-certification.com) for other indoor unit combination and more detail test conditions.
 - 2) Performance of Multiple Module Outdoor unit is weighted average of Single Module outdoor units.
 - 3) Allowed combination ratio of the total rated indoor unit capacity over the rated outdoor unit capacity is 50~130%.
 - 4) Sound pressure level is obtained in an anechoic room.
 - Sound pressure level is a relative value, depending on the distance and acoustic environment.
 - Sound pressure level may differ depending on operation condition.
 - dBA = A-weighted sound pressure level
 - Reference acoustic pressure 0 dB = 20uPa
 - 5) Sound power level is an absolute value that a sound source generates.
 - dBA = A-weighted sound power level
 - Reference power : 1pW
 - Measured according to ISO 3741
 - 6) Sound values of multi combination are theoretical values based on sound results of individual installed units.
 - 7) These products contain R410A (GWP=2,088) which is fluorinated greenhouse gas.
 - 8) If outdoor unit is located in a higher position than indoor unit, level difference is 110m or under.
 - (If the level difference is higher than 50m, make a decision by PDM kit installation Guide software whether the PDM kit should be installed or not.)
 - PDM kit: Pressure Drop Modulation kit
 - When the outdoor unit is below the indoor unit & the level differences are 40m or more, contact your local dealer for more information.
 - 9) In case you want to know more information regarding capacity and correction, please refer to capacity table TDB on pvi.samsung.com site.
 - 10) Recommended combination

* Ducted

Capacity	Indoor Units	Capacity	Indoor Units
8HP	AM056ANHPKH×4	18HP	AM056ANHPKH×4 + AM071ANHPKH×4
10HP	AM071ANHPKH×4	20HP	AM071ANHPKH×8
12HP	AM056ANHPKH×6	22HP	AM071ANHPKH×4 + AM090ANHPKH×4
14HP	AM056ANHPKH×1 + AM071ANHPKH×5	24HP	AM071ANHPKH×1 + AM090ANLDKH×7
16HP	AM056ANHPKH×2 + AM090ANHPKH×4	26HP	AM090ANLDKH×6 + AM112ANLDKH×2

* Non-ducted

Capacity	Indoor Units	Capacity	Indoor Units
8HP	AM028AN4PKH + AM056AN4PKH×2 + AM090AN4PKH	18HP	AM028AN4PKH + AM056AN4PKH + AM056AN4PKH + AM056AN4PKH×2 + AM090AN4PKH×2 + AM128AN4PKH
10HP	AM056AN4PKH×2 + AM090AN4PKH×2	20HP	AM028AN4PKH + AM056AN4PKH×2 + AM090AN4PKH×2 + AM128AN4PKH
12HP	AM028AN4PKH×2 + AM056AN4PKH×2 + AM090AN4PKH×2	22HP	AM028AN4PKH + AM056AN4PKH + AM056AN4PKH + AM090AN4PKH×2 + AM128AN4PKH
14HP	AM028AN4PKH + AM056AN4PKH + AM056AN4PKH + AM071AN4PKH + AM090AN4PKH + AM128AN4PKH	24HP	AM071AN4PKH + AM128AN4PKH×2 + AM128AN4PKH×3
16HP	AM028AN4PKH + AM056AN4PKH + AM090AN4PKH×3 + AM128AN4PKH	26HP	AM071AN4PKH + AM128AN4PKH + AM128AN4PKH×4

2. Specification

Premium energy efficiency

Model Name				AM440AXVGGH1EU	AM460AXVGGH1EU	AM480AXVGGH1EU
			Outdoor unit module 1	AM180AXVGGH/EU	AM200AXVGGH/EU	AM220AXVGGH/EU
			Outdoor unit module 2	AM260AXVGGH/EU	AM260AXVGGH/EU	AM260AXVGGH/EU
			Outdoor unit module 3	-	-	-
Outdoor unit module 4			-	-	-	-
Power Supply			Ø, #, V, Hz	3, 4, 380-415, 50	3, 4, 380-415, 50	3, 4, 380-415, 50
Mode			-	HEAT PUMP	HEAT PUMP	HEAT PUMP
Performance	HP		HP	44	46	48
	Capacity	Cooling(Rated)	kW	123.2	128.8	134.4
		Heating(Rated)	kW	118.4	124.0	129.6
		Heating(Max)	kW	138.6	144.9	151.2
Maximum number of connectable indoor units			EA	64	64	64
Total capacity of the connected Indoor Units			Min.	kW	61.6	64.4
			Max.	kW	160.2	167.4
Current	Current Input (Ducted)	Cooling(Rated)	A	84.40	96.24	101.76
		Heating(Rated)	A	66.25	70.83	72.40
	Current Input (Non-Ducted)	Cooling(Rated)	A	83.48	93.82	94.54
		Heating(Rated)	A	69.31	70.22	88.40
	Current	Minimum Ssc	MVA	16.6	17.2	17.6
		MCA	A	99.2	103.0	106.0
MFA		A	125	125	125	
Efficiency	SEER	Ducted	W/W	-	-	-
	SCOP		W/W	-	-	-
	igs.c		%	-	-	-
	igs.h		%	-	-	-
	SEER	Non_Ducted	W/W	-	-	-
	SCOP		W/W	-	-	-
	igs.c		%	-	-	-
	igs.h		%	-	-	-
Pdesignh			kW	61.3	64.1	64.8
Casing	Material	Body	-	GI Steel Plate	GI Steel Plate	GI Steel Plate
		Base	-	GI Steel Plate	GI Steel Plate	GI Steel Plate
Heat Exchanger	Type		-	Fin & Tube	Fin & Tube	Fin & Tube
	Material	Fin	-	Al	Al	Al
		Tube	-	Cu	Cu	Cu
	Fin Treatment		-	Anti-corrosion	Anti-corrosion	Anti-corrosion
Compressor	Type		-	Inverter Scroll x 3	Inverter Scroll x 3	Inverter Scroll x 4
	Output		kW x n	(8.93 x 1) x 1 + (6.67 x 2) x 1	(8.93 x 1) x 1 + (6.67 x 2) x 1	(6.67 x 2) x 2
	Model Name		-	(DS4GM7090FV* x 1) x 1 + (DS4GR7066FV* x 2) x 1	(DS4GM7090FV* x 1) x 1 + (DS4GR7066FV* x 2) x 1	(DS4GR7066FV* x 2) x 2
	Oil	Type	-	PVE	PVE	PVE
Initial charge		cc x n	(1,400 x 1) x 1 + (1,100 x 2) x 1	(1,400 x 1) x 1 + (1,100 x 2) x 1	(1,100 x 2) x 2	
Fan	Type		-	Propeller	Propeller	Propeller
	Discharge direction		-	Top	Top	Top
	Quantity		EA	4	4	4
	Air Flow Rate		m³/min	313 x 1 + 365 x 1	313 x 1 + 365 x 1	342 x 1 + 365 x 1
			l/s	5,209 x 1 + 6,089 x 1	5,209 x 1 + 6,089 x 1	5,698 x 1 + 6,089 x 1
	External Static Pressure	Max.	mmAq	11	11	11
Pa			110	110	110	
Fan Motor	Type		-	BLDC Motor	BLDC Motor	BLDC Motor
	Output		W x n	(620 x 2) x 2	(620 x 2) x 2	(620 x 2) x 2
Piping Connections	Liquid Pipe	Type		Braze connection	Braze connection	Braze connection
		Φ, mm (inch)		19.05 (3/4)	19.05 (3/4)	19.05 (3/4)
	Gas Pipe	Type		Braze connection	Braze connection	Braze connection
		Φ, mm (inch)		41.28 (1-5/8)	41.28 (1-5/8)	41.28 (1-5/8)
Heat Insulation		-	Both liquid and gas pipes	Both liquid and gas pipes	Both liquid and gas pipes	

2. Specification

Premium energy efficiency

Model Name				AM440AXVGGH1EU	AM460AXVGGH1EU	AM480AXVGGH1EU
	Outdoor unit module 1			AM180AXVGGH/EU	AM200AXVGGH/EU	AM220AXVGGH/EU
	Outdoor unit module 2			AM260AXVGGH/EU	AM260AXVGGH/EU	AM260AXVGGH/EU
	Outdoor unit module 3			-	-	-
Outdoor unit module 4			-	-	-	
Piping Connections	Piping length (ODU-IDU)	Max. [Equiv.]	m	200[220]	200[220]	200[220]
	Piping length (1st Branch-IDU)	Max.	m	90	90	90
	Total piping length (System)	Max.	m	1,000	1,000	1,000
	Level difference (ODU in highest position)	Max.	m	110	110	110
	Level difference (IDU in highest position)	Max.	m	110	110	110
	Level difference (IDU-IDU)	Max.	m	50	50	50
Wiring connections	Transmission Cable	Min.	mm ²	0.75	0.75	0.75
		Remark	-	F1, F2	F1, F2	F1, F2
	Power supply intake		-	Both indoor and outdoor unit	Both indoor and outdoor unit	Both indoor and outdoor unit
Refrigerant	Type		-	R410A	R410A	R410A
	Factory Charging		kg	10.5 x 1 + 14.0 x 1	10.5 x 1 + 14.0 x 1	10.5 x 1 + 14.0 x 1
			tCO ₂ e		51.16	51.16
Sound	Sound Pressure	Cooling	dB(A)	66	66	68
		Heating	dB(A)	68	68	69
	Sound Power		dB(A)	88	89	90
External Dimension	Net Weight		kg	268 x 1 + 325 x 1	268 x 1 + 325 x 1	301 x 1 + 325 x 1
	Shipping Weight		kg	285 x 1 + 342 x 1	285 x 1 + 342 x 1	318 x 1 + 342 x 1
	Net Dimensions (WxHxD)		mm	(1,295 x 1,695 x 765) x 2	(1,295 x 1,695 x 765) x 2	(1,295 x 1,695 x 765) x 2
	Shipping Dimensions (WxHxD)		mm	(1,363 x 1,887 x 829) x 2	(1,363 x 1,887 x 829) x 2	(1,363 x 1,887 x 829) x 2
Operating Temp. Range	Cooling		°C	-5 ~ 50	-5 ~ 50	-5 ~ 50
	Heating		°C	-25 ~ 24	-25 ~ 24	-25 ~ 24

NOTE

- Specification may be subject to change without prior notice.
- Specification comply with EN14825 and Eurovent test condition
- 1) Performances are based on the following test conditions.
 - Cooling : Indoor temperature 27°CDB, 19°CWB, Outdoor temperature 35°CDB, 24°CWB
 - Heating : Indoor temperature 20°CDB, 15°CWB, Outdoor temperature 7°CDB, 6°CWB
 - Equivalent refrigerant pipe length 5m, Level differences 0m
 - Refer to EUROVENT website(www.eurovent-certification.com) for other indoor unit combination and more detail test conditions.
- 2) Performance of Multiple Module Outdoor unit is weighted average of Single Module outdoor units.
- 3) Allowed combination ratio of the total rated indoor unit capacity over the rated outdoor unit capacity is 50~130%.
- 4) Sound pressure level is obtained in an anechoic room.
 - Sound pressure level is a relative value, depending on the distance and acoustic environment.
 - Sound pressure level may differ depending on operation condition.
 - dBA = A-weighted sound pressure level
 - Reference acoustic pressure 0 dB = 20uPa
- 5) Sound power level is an absolute value that a sound source generates.
 - dBA = A-weighted sound power level
 - Reference power: 1pW
 - Measured according to ISO 3741
- 6) Sound values of multi combination are theoretical values based on sound results of individual installed units.
- 7) These products contain R410A (GWP=2,088) which is fluorinated greenhouse gas.
- 8) If outdoor unit is located in a higher position than indoor unit, level difference is 110m or under.
 - (If the level difference is higher than 50m, make a decision by PDM kit installation Guide software whether the PDM kit should be installed or not.)
 - PDM kit: Pressure Drop Modulation kit
 - When the outdoor unit is below the indoor unit & the level differences are 40m or more, contact your local dealer for more information.
- 9) In case you want to know more information regarding capacity and correction, please refer to capacity table TDB on pvi.samsung.com site.
- 10) Recommended combination

* Ducted

Capacity	Indoor Units	Capacity	Indoor Units
8HP	AM056ANHPKH×4	18HP	AM056ANHPKH×4 + AM071ANHPKH×4
10HP	AM071ANHPKH×4	20HP	AM071ANHPKH×8
12HP	AM056ANHPKH×6	22HP	AM071ANHPKH×4 + AM090ANHPKH×4
14HP	AM056ANHPKH×1 + AM071ANHPKH×5	24HP	AM071ANHPKH×1 + AM090ANLDKH×7
16HP	AM056ANHPKH×2 + AM090ANHPKH×4	26HP	AM090ANLDKH×6 + AM112ANLDKH×2

* Non-ducted

Capacity	Indoor Units	Capacity	Indoor Units
8HP	AM028AN4PKH + AM056AN4PKH×2 + AM090AN4PKH	18HP	AM028AN4PKH + AM056AN4PKH + AM056AN4PKH + AM056AN4PKH×2 + AM090AN4PKH×2 + AM128AN4PKH
10HP	AM056AN4PKH×2 + AM090AN4PKH×2	20HP	AM028AN4PKH + AM056AN4PKH×2 + AM090AN4PKH×2 + AM128AN4PKH
12HP	AM028AN4PKH×2 + AM056AN4PKH×2 + AM090AN4PKH×2	22HP	AM028AN4PKH + AM056AN4PKH + AM056AN4PKH + AM090AN4PKH×2 + AM128AN4PKH
14HP	AM028AN4PKH + AM056AN4PKH + AM056AN4PKH + AM071AN4PKH + AM090AN4PKH + AM128AN4PKH	24HP	AM071AN4PKH + AM128AN4PKH×2 + AM128AN4PKH×3
16HP	AM028AN4PKH + AM056AN4PKH + AM090AN4PKH×3 + AM128AN4PKH	26HP	AM071AN4PKH + AM128AN4PKH + AM128AN4PKH×4

2. Specification

Premium energy efficiency

Model Name				AM500AXVGGH1EU	AM520AXVGGH1EU	AM540AXVGGH1EU	
			Outdoor unit module 1	AM240AXVGGH/EU	AM260AXVGGH/EU	AM100AXVGGH/EU	
			Outdoor unit module 2	AM260AXVGGH/EU	AM260AXVGGH/EU	AM180AXVGGH/EU	
			Outdoor unit module 3	-	-	AM260AXVGGH/EU	
Outdoor unit module 4			-	-	-	-	
Power Supply			Ø, #, V, Hz	3, 4, 380-415, 50	3, 4, 380-415, 50	3, 4, 380-415, 50	
Mode			-	HEAT PUMP	HEAT PUMP	HEAT PUMP	
Performance	HP		HP	50	52	54	
	Capacity	Cooling(Rated)	kW	140.0	145.6	151.2	
		Heating(Rated)	kW	135.2	136.0	146.4	
		Heating(Max)	kW	157.5	163.8	170.1	
Maximum number of connectable indoor units			EA	64	64	64	
Total capacity of the connected Indoor Units			Min.	kW	70.0	72.8	
			Max.	kW	182.0	189.3	196.6
Current	Current Input (Ducted)		Cooling(Rated)	A	106.23	115.22	100.37
			Heating(Rated)	A	89.31	90.22	77.66
	Current Input (Non-Ducted)		Cooling(Rated)	A	104.88	115.22	97.32
			Heating(Rated)	A	89.31	90.22	80.14
	Current		Minimum Ssc	MVA	19.5	20.4	20.0
			MCA	A	115.0	120.0	120.4
MFA			A	150	150	150	
Efficiency	SEER		Ducted	W/W	-	-	-
				W/W	-	-	-
				%	-	-	-
	SCOP		Ducted	W/W	-	-	-
				W/W	-	-	-
				%	-	-	-
	SEER		Non_Ducted	W/W	-	-	-
				W/W	-	-	-
				%	-	-	-
SCOP		Non_Ducted	W/W	-	-	-	
			W/W	-	-	-	
			%	-	-	-	
Pdesignh			kW	65.4	66	78.2	
Casing	Material		Body	-	GI Steel Plate	GI Steel Plate	GI Steel Plate
			Base	-	GI Steel Plate	GI Steel Plate	GI Steel Plate
Heat Exchanger	Type		-	Fin & Tube	Fin & Tube	Fin & Tube	
	Material		Fin	-	Al	Al	Al
			Tube	-	Cu	Cu	Cu
	Fin Treatment			-	Anti-corrosion	Anti-corrosion	Anti-corrosion
Compressor	Type		-	Inverter Scroll x 4	Inverter Scroll x 4	Inverter Scroll x 4	
	Output		kW x n	(6.67 x 2) x 2	(6.67 x 2) x 2	(6.67 x 1) x 1 + (8.93 x 1) x 1 + (6.67 x 2) x 1	
	Model Name		-	(DS4GR7066FV* x 2) x 2	(DS4GR7066FV* x 2) x 2	(DS4GR7066FV* x 1) x 1 + (DS4GM7090FV* x 1) x 1 + (DS4GR7066FV* x 2) x 1	
	Oil		Type	-	PVE	PVE	PVE
Initial charge			cc x n	(1,100 x 2) x 2	(1,100 x 2) x 2	(1,100 x 1) x 1 + (1,400 x 1) x 1 + (1,100 x 2) x 1	
Fan	Type		-	Propeller	Propeller	Propeller	
	Discharge direction		-	Top	Top	Top	
	Quantity		EA	4	4	5	
	Air Flow Rate		m³/min	365 x 2	365 x 2	181 x 1 + 313 x 1 + 365 x 1	
			l/s	6,089 x 2	6,089 x 2	3,019 x 1 + 5,209 x 1 + 6,089 x 1	
	External Static Pressure		Max.	mmAq	8	8	11
Pa				80	80	110	
Fan Motor	Type		-	BLDC Motor	BLDC Motor	BLDC Motor	
	Output		W x n	(620 x 2) x 2	(620 x 2) x 2	(630 x 1) x 1 + (620 x 2) x 2	
Piping Connections	Liquid Pipe		Type	Braze connection	Braze connection	Braze connection	
			Φ, mm (inch)	19.05 (3/4)	19.05 (3/4)	19.05 (3/4)	
	Gas Pipe		Type	Braze connection	Braze connection	Braze connection	
			Φ, mm (inch)	41.28 (1-5/8)	41.28 (1-5/8)	41.28 (1-5/8)	
Heat Insulation			-	Both liquid and gas pipes	Both liquid and gas pipes	Both liquid and gas pipes	

2. Specification

Premium energy efficiency

Model Name				AM500AXVGGH1EU	AM520AXVGGH1EU	AM540AXVGGH1EU
	Outdoor unit module 1			AM240AXVGGH/EU	AM260AXVGGH/EU	AM100AXVGGH/EU
	Outdoor unit module 2			AM260AXVGGH/EU	AM260AXVGGH/EU	AM180AXVGGH/EU
	Outdoor unit module 3			-	-	AM260AXVGGH/EU
Outdoor unit module 4			-	-	-	
Piping Connections	Piping length (ODU-IDU)	Max. [Equiv.]	m	200[220]	200[220]	200[220]
	Piping length (1st Branch-IDU)	Max.	m	90	90	90
	Total piping length (System)	Max.	m	1,000	1,000	1,000
	Level difference (ODU in highest position)	Max.	m	110	110	110
	Level difference (IDU in highest position)	Max.	m	110	110	110
	Level difference (IDU-IDU)	Max.	m	50	50	50
Wiring connections	Transmission Cable	Min.	mm ²	0.75	0.75	0.75
		Remark	-	F1, F2	F1, F2	F1, F2
	Power supply intake		-	Both indoor and outdoor unit	Both indoor and outdoor unit	Both indoor and outdoor unit
Refrigerant	Type		-	R410A	R410A	R410A
	Factory Charging		kg	14.0 x 2	14.0 x 2	7.0 x 1 + 10.5 x 1 + 14.0 x 1
			tCO ₂ e	58.46	58.46	65.77
Sound	Sound Pressure	Cooling	dB(A)	68	68	66
		Heating	dB(A)	70	70	69
	Sound Power			dB(A)	90	90
External Dimension	Net Weight		kg	325 x 2	325 x 2	205 x 1 + 268 x 1 + 325 x 1
	Shipping Weight		kg	342 x 2	342 x 2	219 x 1 + 285 x 1 + 342 x 1
	Net Dimensions (WxHxD)		mm	(1,295 x 1,695 x 765) x 2	(1,295 x 1,695 x 765) x 2	(930 x 1,695 x 765) x 1 + (1,295 x 1,695 x 765) x 2
	Shipping Dimensions (WxHxD)		mm	(1,363 x 1,887 x 829) x 2	(1,363 x 1,887 x 829) x 2	(998 x 1,887 x 829) x 1 + (1,363 x 1,887 x 829) x 2
Operating Temp. Range	Cooling		°C	-5 ~ 50	-5 ~ 50	-5 ~ 50
	Heating		°C	-25 ~ 24	-25 ~ 24	-25 ~ 24

NOTE

- Specification may be subject to change without prior notice.
- Specification comply with EN14825 and Eurovent test condition
- 1) Performances are based on the following test conditions.
 - Cooling : Indoor temperature 27°CDB, 19°CWB, Outdoor temperature 35°CDB, 24°CWB
 - Heating : Indoor temperature 20°CDB, 15°CWB, Outdoor temperature 7°CDB, 6°CWB
 - Equivalent refrigerant pipe length 5m, Level differences 0m
 - Refer to EUROVENT website(www.eurovent-certification.com) for other indoor unit combination and more detail test conditions.
- 2) Performance of Multiple Module Outdoor unit is weighted average of Single Module outdoor units.
- 3) Allowed combination ratio of the total rated indoor unit capacity over the rated outdoor unit capacity is 50~130%.
- 4) Sound pressure level is obtained in an anechoic room.
 - Sound pressure level is a relative value, depending on the distance and acoustic environment.
 - Sound pressure level may differ depending on operation condition.
 - dBA = A-weighted sound pressure level
 - Reference acoustic pressure 0 dB = 20uPa
- 5) Sound power level is an absolute value that a sound source generates.
 - dBA = A-weighted sound power level
 - Reference power: 1pW
 - Measured according to ISO 3741
- 6) Sound values of multi combination are theoretical values based on sound results of individual installed units.
- 7) These products contain R410A (GWP=2,088) which is fluorinated greenhouse gas.
- 8) If outdoor unit is located in a higher position than indoor unit, level difference is 110m or under.
 - (If the level difference is higher than 50m, make a decision by PDM kit installation Guide software whether the PDM kit should be installed or not.)
 - PDM kit: Pressure Drop Modulation kit
 - When the outdoor unit is below the indoor unit & the level differences are 40m or more, contact your local dealer for more information.
- 9) In case you want to know more information regarding capacity and correction, please refer to capacity table TDB on pvi.samsung.com site.
- 10) Recommended combination

* Ducted

Capacity	Indoor Units	Capacity	Indoor Units
8HP	AM056ANHPKH×4	18HP	AM056ANHPKH×4 + AM071ANHPKH×4
10HP	AM071ANHPKH×4	20HP	AM071ANHPKH×8
12HP	AM056ANHPKH×6	22HP	AM071ANHPKH×4 + AM090ANHPKH×4
14HP	AM056ANHPKH×1 + AM071ANHPKH×5	24HP	AM071ANHPKH×1 + AM090ANLDKH×7
16HP	AM056ANHPKH×2 + AM090ANHPKH×4	26HP	AM090ANLDKH×6 + AM112ANLDKH×2

* Non-ducted

Capacity	Indoor Units	Capacity	Indoor Units
8HP	AM028AN4PKH + AM056AN4PKH×2 + AM090AN4PKH	18HP	AM028AN4PKH + AM056AN4PKH + AM056AN4PKH + AM056AN4PKH×2 + AM090AN4PKH×2 + AM128AN4PKH
10HP	AM056AN4PKH×2 + AM090AN4PKH×2	20HP	AM028AN4PKH + AM056AN4PKH×2 + AM090AN4PKH×2 + AM128AN4PKH
12HP	AM028AN4PKH×2 + AM056AN4PKH×2 + AM090AN4PKH×2	22HP	AM028AN4PKH + AM056AN4PKH + AM056AN4PKH + AM090AN4PKH×2 + AM128AN4PKH
14HP	AM028AN4PKH + AM056AN4PKH + AM056AN4PKH + AM071AN4PKH + AM090AN4PKH + AM128AN4PKH	24HP	AM028AN4PKH×3 + AM128AN4PKH×2 + AM28AN4PKH×3
16HP	AM028AN4PKH + AM056AN4PKH + AM090AN4PKH×3 + AM128AN4PKH	26HP	AM071AN4PKH + AM128AN4PKH×2 + AM28AN4PKH×4

2. Specification

Premium energy efficiency

Model Name				AM560AXVGGH1EU	AM580AXVGGH1EU	AM600AXVGGH1EU	
			Outdoor unit module 1		AM120AXVGGH/EU	AM120AXVGGH/EU	AM120AXVGGH/EU
			Outdoor unit module 2		AM180AXVGGH/EU	AM200AXVGGH/EU	AM220AXVGGH/EU
			Outdoor unit module 3		AM260AXVGGH/EU	AM260AXVGGH/EU	AM260AXVGGH/EU
Outdoor unit module 4				-	-	-	
Power Supply			Ø, #, V, Hz	3, 4, 380-415, 50	3, 4, 380-415, 50	3, 4, 380-415, 50	
Mode			-	HEAT PUMP	HEAT PUMP	HEAT PUMP	
Performance	HP		HP	56	58	60	
	Capacity	Cooling(Rated)	kW	156.8	162.4	168.0	
		Heating(Rated)	kW	152.0	157.6	163.2	
		Heating(Max)	kW	176.4	182.7	189.0	
Maximum number of connectable indoor units			EA	64	64	64	
Total capacity of the connected Indoor Units			Min.	kW	78.4	81.2	
			Max.	kW	203.8	211.1	
Current	Current Input (Ducted)	Cooling(Rated)	A	103.65	115.49	121.01	
		Heating(Rated)	A	80.62	85.20	86.77	
	Current Input (Non-Ducted)	Cooling(Rated)	A	107.66	108.38	118.72	
		Heating(Rated)	A	81.05	99.23	100.14	
	Current	Minimum Ssc	MVA	20.6	21.2	21.6	
		MCA	A	124.2	128.0	131.0	
MFA		A	150	150	150		
Efficiency	SEER	Ducted	W/W	-	-	-	
			W/W	-	-	-	
			%	-	-	-	
			%	-	-	-	
	SEER	Non_Ducted	W/W	-	-	-	
			W/W	-	-	-	
			%	-	-	-	
			%	-	-	-	
Pdesignh			kW	81	83.8	84.5	
Casing	Material	Body	-	GI Steel Plate	GI Steel Plate	GI Steel Plate	
		Base	-	GI Steel Plate	GI Steel Plate	GI Steel Plate	
Heat Exchanger	Type		-	Fin & Tube	Fin & Tube	Fin & Tube	
	Material	Fin	-	Al	Al	Al	
		Tube	-	Cu	Cu	Cu	
Fin Treatment			-	Anti-corrosion	Anti-corrosion	Anti-corrosion	
Compressor	Type		-	Inverter Scroll x 4	Inverter Scroll x 4	Inverter Scroll x 5	
	Output		kW x n	(6.67 x 1) x 1 + (8.93 x 1) x 1 + (6.67 x 2) x 1	(6.67 x 1) x 1 + (8.93 x 1) x 1 + (6.67 x 2) x 1	(6.67 x 1) x 1 + (6.67 x 2) x 2	
	Model Name		-	(DS4GR7066FV* x 1) x 1 + (DS4GM7090FV* x 1) x 1 + (DS4GR7066FV* x 2) x 1	(DS4GR7066FV* x 1) x 1 + (DS4GM7090FV* x 1) x 1 + (DS4GR7066FV* x 2) x 1	(DS4GR7066FV* x 1) x 1 + (DS4GR7066FV* x 2) x 2	
	Oil	Type	-	PVE	PVE	PVE	
Initial charge		cc x n	(1,100 x 1) x 1 + (1,400 x 1) x 1 + (1,100 x 2) x 1	(1,100 x 1) x 1 + (1,400 x 1) x 1 + (1,100 x 2) x 1	(1,100 x 1) x 1 + (1,100 x 2) x 2		
Fan	Type		-	Propeller	Propeller	Propeller	
	Discharge direction		-	Top	Top	Top	
	Quantity		EA	5	5	5	
	Air Flow Rate		m³/min	196 x 1 + 313 x 1 + 365 x 1	196 x 1 + 313 x 1 + 365 x 1	196 x 1 + 342 x 1 + 365 x 1	
			l/s	3,260 x 1 + 5,209 x 1 + 6,089 x 1	3,260 x 1 + 5,209 x 1 + 6,089 x 1	3,260 x 1 + 5,698 x 1 + 6,089 x 1	
	External Static Pressure	Max.	mmAq	11	11	11	
Pa			110	110	110		
Fan Motor	Type		-	BLDC Motor	BLDC Motor	BLDC Motor	
	Output		W x n	(630 x 1) x 1 + (620 x 2) x 2	(630 x 1) x 1 + (620 x 2) x 2	(630 x 1) x 1 + (620 x 2) x 2	
Piping Connections	Liquid Pipe		Type	Braze connection	Braze connection	Braze connection	
			Φ, mm (inch)	19.05 (3/4)	19.05 (3/4)	19.05 (3/4)	
	Gas Pipe		Type	Braze connection	Braze connection	Braze connection	
			Φ, mm (inch)	41.28 (1-5/8)	41.28 (1-5/8)	41.28 (1-5/8)	
Heat Insulation			-	Both liquid and gas pipes	Both liquid and gas pipes	Both liquid and gas pipes	

2. Specification

Premium energy efficiency

Model Name				AM560AXVGGH1EU	AM580AXVGGH1EU	AM600AXVGGH1EU
	Outdoor unit module 1			AM120AXVGGH/EU	AM120AXVGGH/EU	AM120AXVGGH/EU
	Outdoor unit module 2			AM180AXVGGH/EU	AM200AXVGGH/EU	AM220AXVGGH/EU
	Outdoor unit module 3			AM260AXVGGH/EU	AM260AXVGGH/EU	AM260AXVGGH/EU
Outdoor unit module 4			-	-	-	
Piping Connections	Piping length (ODU-IDU)	Max. [Equiv.]	m	200[220]	200[220]	200[220]
	Piping length (1st Branch-IDU)	Max.	m	90	90	90
	Total piping length (System)	Max.	m	1,000	1,000	1,000
	Level difference (ODU in highest position)	Max.	m	110	110	110
	Level difference (IDU in highest position)	Max.	m	110	110	110
	Level difference (IDU-IDU)	Max.	m	50	50	50
Wiring connections	Transmission Cable	Min.	mm ²	0.75	0.75	0.75
		Remark	-	F1, F2	F1, F2	F1, F2
	Power supply intake		-	Both indoor and outdoor unit	Both indoor and outdoor unit	Both indoor and outdoor unit
Refrigerant	Type		-	R410A	R410A	R410A
	Factory Charging		kg	7.0 x 1 + 10.5 x 1 + 14.0 x 1	7.0 x 1 + 10.5 x 1 + 14.0 x 1	7.0 x 1 + 10.5 x 1 + 14.0 x 1
			tCO _{2e}	65.77	65.77	65.77
Sound	Sound Pressure	Cooling	dB(A)	67	68	68
		Heating	dB(A)	70	70	70
	Sound Power		dB(A)	89	89	90
External Dimension	Net Weight		kg	205 x 1 + 268 x 1 + 325 x 1	205 x 1 + 268 x 1 + 325 x 1	205 x 1 + 301 x 1 + 325 x 1
	Shipping Weight		kg	219 x 1 + 285 x 1 + 342 x 1	219 x 1 + 285 x 1 + 342 x 1	219 x 1 + 318 x 1 + 342 x 1
	Net Dimensions (WxHxD)		mm	(930 x 1,695 x 765) x 1 + (1,295 x 1,695 x 765) x 2	(930 x 1,695 x 765) x 1 + (1,295 x 1,695 x 765) x 2	(930 x 1,695 x 765) x 1 + (1,295 x 1,695 x 765) x 2
	Shipping Dimensions (WxHxD)		mm	(998 x 1,887 x 829) x 1 + (1,363 x 1,887 x 829) x 2	(998 x 1,887 x 829) x 1 + (1,363 x 1,887 x 829) x 2	(998 x 1,887 x 829) x 1 + (1,363 x 1,887 x 829) x 2
Operating Temp. Range	Cooling		°C	-5 ~ 50	-5 ~ 50	-5 ~ 50
	Heating		°C	-25 ~ 24	-25 ~ 24	-25 ~ 24

NOTE

- Specification may be subject to change without prior notice.
 - Specification comply with EN14825 and Eurovent test condition
- 1) Performances are based on the following test conditions.
 - Cooling : Indoor temperature 27°CDB, 19°CWB, Outdoor temperature 35°CDB, 24°CWB
 - Heating : Indoor temperature 20°CDB, 15°CWB, Outdoor temperature 7°CDB, 6°CWB
 - Equivalent refrigerant pipe length 5m, Level differences 0m
 - Refer to EUROVENT website(www.eurovent-certification.com) for other indoor unit combination and more detail test conditions.
 - 2) Performance of Multiple Module Outdoor unit is weighted average of Single Module outdoor units.
 - 3) Allowed combination ratio of the total rated indoor unit capacity over the rated outdoor unit capacity is 50~130%.
 - 4) Sound pressure level is obtained in an anechoic room.
 - Sound pressure level is a relative value, depending on the distance and acoustic environment.
 - Sound pressure level may differ depending on operation condition.
 - dBA = A-weighted sound pressure level
 - Reference acoustic pressure 0 dB = 20uPa
 - 5) Sound power level is an absolute value that a sound source generates.
 - dBA = A-weighted sound power level
 - Reference power : 1pW
 - Measured according to ISO 3741
 - 6) Sound values of multi combination are theoretical values based on sound results of individual installed units.
 - 7) These products contain R410A (GWP=2,088) which is fluorinated greenhouse gas.
 - 8) If outdoor unit is located in a higher position than indoor unit, level difference is 110m or under.
 - (If the level difference is higher than 50m, make a decision by PDM kit installation Guide software whether the PDM kit should be installed or not.)
 - PDM kit: Pressure Drop Modulation kit
 - When the outdoor unit is below the indoor unit & the level differences are 40m or more, contact your local dealer for more information.
 - 9) In case you want to know more information regarding capacity and correction, please refer to capacity table TDB on pvi.samsung.com site.
 - 10) Recommended combination

* Ducted

Capacity	Indoor Units	Capacity	Indoor Units
8HP	AM056ANHPKH×4	18HP	AM056ANHPKH×4 + AM071ANHPKH×4
10HP	AM071ANHPKH×4	20HP	AM071ANHPKH×8
12HP	AM056ANHPKH×6	22HP	AM071ANHPKH×4 + AM090ANHPKH×4
14HP	AM056ANHPKH×1 + AM071ANHPKH×5	24HP	AM071ANHPKH×1 + AM090ANLDKH×7
16HP	AM056ANHPKH×2 + AM090ANHPKH×4	26HP	AM090ANLDKH×6 + AM112ANLDKH×2

* Non-ducted

Capacity	Indoor Units	Capacity	Indoor Units
8HP	AM028AN4PKH + AM056AN4PKH×2 + AM090AN4PKH	18HP	AM028AN4PKH + AM056AN4PKH + AM056AN4PKH + AM056AN4PKH×2 + AM090AN4PKH×2 + AM128AN4PKH
10HP	AM056AN4PKH×2 + AM090AN4PKH×2	20HP	AM028AN4PKH + AM056AN4PKH×2 + AM090AN4PKH×2 + AM128AN4PKH
12HP	AM028AN4PKH×2 + AM056AN4PKH×2 + AM090AN4PKH×2	22HP	AM028AN4PKH + AM056AN4PKH + AM056AN4PKH + AM090AN4PKH + AM128AN4PKH
14HP	AM028AN4PKH + AM056AN4PKH + AM056AN4PKH + AM071AN4PKH + AM090AN4PKH + AM128AN4PKH	24HP	AM028AN4PKH×3 + AM128AN4PKH×2 + AM128AN4PKH×3
16HP	AM028AN4PKH + AM056AN4PKH + AM090AN4PKH×3 + AM128AN4PKH	26HP	AM071AN4PKH + AM128AN4PKH×2 + AM128AN4PKH×4

2. Specification

Premium energy efficiency

Model Name				AM620AXVGGH1EU	AM640AXVGGH1EU	AM660AXVGGH1EU
			Outdoor unit module 1	AM100AXVGGH/EU	AM120AXVGGH/EU	AM200AXVGGH/EU
			Outdoor unit module 2	AM260AXVGGH/EU	AM260AXVGGH/EU	AM200AXVGGH/EU
			Outdoor unit module 3	AM260AXVGGH/EU	AM260AXVGGH/EU	AM260AXVGGH/EU
Outdoor unit module 4				-	-	-
Power Supply			Ø, #, V, Hz	3, 4, 380-415, 50	3, 4, 380-415, 50	3, 4, 380-415, 50
Mode			-	HEAT PUMP	HEAT PUMP	HEAT PUMP
Performance	HP		HP	62	64	66
	Capacity	Cooling(Rated)	kW	173.6	179.2	184.8
		Heating(Rated)	kW	164.0	169.6	180.0
		Heating(Max)	kW	195.3	201.6	207.9
Maximum number of connectable indoor units			EA	64	64	64
Total capacity of the connected Indoor Units			Min.	kW	86.8	89.6
			Max.	kW	225.7	233.0
Current	Current Input (Ducted)	Cooling(Rated)	A	131.19	134.47	134.87
		Heating(Rated)	A	101.63	104.59	96.55
	Current Input (Non-Ducted)	Cooling(Rated)	A	129.06	132.96	123.73
		Heating(Rated)	A	101.05	104.47	110.25
	Current	Minimum Ssc	MVA	23.8	24.4	24.2
		MCA	A	141.2	145.0	146.0
MFA		A	175	175	175	
Efficiency	SEER	Ducted	W/W	-	-	-
	SCOP		W/W	-	-	-
	igs.c		%	-	-	-
	igs.h		%	-	-	-
	SEER	Non_Ducted	W/W	-	-	-
	SCOP		W/W	-	-	-
	igs.c		%	-	-	-
	igs.h		%	-	-	-
Pdesignh			kW	82.9	85.7	95.2
Casing	Material	Body	-	GI Steel Plate	GI Steel Plate	GI Steel Plate
		Base	-	GI Steel Plate	GI Steel Plate	GI Steel Plate
Heat Exchanger	Type		-	Fin & Tube	Fin & Tube	Fin & Tube
	Material	Fin	-	Al	Al	Al
		Tube	-	Cu	Cu	Cu
	Fin Treatment		-	Anti-corrosion	Anti-corrosion	Anti-corrosion
Compressor	Type		-	Inverter Scroll x 5	Inverter Scroll x 5	Inverter Scroll x 4
	Output		kW x n	(6.67 x 1) x 1 + (6.67 x 2) x 2	(6.67 x 1) x 1 + (6.67 x 2) x 2	(8.93 x 1) x 2 + (6.67 x 2) x 1
	Model Name		-	(DS4GR7066FV* x 1) x 1 + (DS4GR7066FV* x 2) x 2	(DS4GR7066FV* x 1) x 1 + (DS4GR7066FV* x 2) x 2	(DS4GM7090FV* x 1) x 2 + (DS4GR7066FV* x 2) x 1
	Oil	Type	-	PVE	PVE	PVE
Initial charge		cc x n	(1,100 x 1) x 1 + (1,100 x 2) x 2	(1,100 x 1) x 1 + (1,100 x 2) x 2	(1,400 x 1) x 2 + (1,100 x 2) x 1	
Fan	Type		-	Propeller	Propeller	Propeller
	Discharge direction		-	Top	Top	Top
	Quantity		EA	5	5	6
	Air Flow Rate		m³/min	181 x 1 + 365 x 2	196 x 1 + 365 x 2	313 x 2 + 365 x 1
			l/s	3,019 x 1 + 6,089 x 2	3,260 x 1 + 6,089 x 2	5,209 x 2 + 6,089 x 1
	External Static Pressure	Max.	mmAq	11	11	11
Pa			110	110	110	
Fan Motor	Type		-	BLDC Motor	BLDC Motor	BLDC Motor
	Output		W x n	(630 x 1) x 1 + (620 x 2) x 2	(630 x 1) x 1 + (620 x 2) x 2	(620 x 2) x 3
Piping Connections	Liquid Pipe	Type		Braze connection	Braze connection	Braze connection
		Φ, mm (inch)		22.22 (7/8)	22.22 (7/8)	22.22 (7/8)
	Gas Pipe	Type		Braze connection	Braze connection	Braze connection
		Φ, mm (inch)		53.98 (2-1/8)	53.98 (2-1/8)	53.98 (2-1/8)
Heat Insulation		-		Both liquid and gas pipes	Both liquid and gas pipes	Both liquid and gas pipes

2. Specification

Premium energy efficiency

Model Name				AM620AXVGGH1EU	AM640AXVGGH1EU	AM660AXVGGH1EU
	Outdoor unit module 1			AM100AXVGGH/EU	AM120AXVGGH/EU	AM200AXVGGH/EU
	Outdoor unit module 2			AM260AXVGGH/EU	AM260AXVGGH/EU	AM200AXVGGH/EU
	Outdoor unit module 3			AM260AXVGGH/EU	AM260AXVGGH/EU	AM260AXVGGH/EU
Outdoor unit module 4			-	-	-	
Piping Connections	Piping length (ODU-IDU)	Max. [Equiv.]	m	200[220]	200[220]	200[220]
	Piping length (1st Branch-IDU)	Max.	m	90	90	90
	Total piping length (System)	Max.	m	1,000	1,000	1,000
	Level difference (ODU in highest position)	Max.	m	110	110	110
	Level difference (IDU in highest position)	Max.	m	110	110	110
	Level difference (IDU-IDU)	Max.	m	50	50	50
Wiring connections	Transmission Cable	Min.	mm ²	0.75	0.75	0.75
		Remark	-	F1, F2	F1, F2	F1, F2
	Power supply intake		-	Both indoor and outdoor unit	Both indoor and outdoor unit	Both indoor and outdoor unit
Refrigerant	Type		-	R410A	R410A	R410A
	Factory Charging		kg	7.0 x 1 + 14.0 x 2	7.0 x 1 + 14.0 x 2	10.5 x 2 + 14.0 x 1
			tCO ₂ e	73.08	73.08	73.08
Sound	Sound Pressure	Cooling	dB(A)	68	69	68
		Heating	dB(A)	70	71	70
	Sound Power		dB(A)	90	91	90
External Dimension	Net Weight		kg	205 x 1 + 325 x 2	205 x 1 + 325 x 2	268 x 2 + 325 x 1
	Shipping Weight		kg	219 x 1 + 342 x 2	219 x 1 + 342 x 2	285 x 2 + 342 x 1
	Net Dimensions (WxHxD)		mm	(930 x 1,695 x 765) x 1 + (1,295 x 1,695 x 765) x 2	(930 x 1,695 x 765) x 1 + (1,295 x 1,695 x 765) x 2	(1,295 x 1,695 x 765) x 3
	Shipping Dimensions (WxHxD)		mm	(998 x 1,887 x 829) x 1 + (1,363 x 1,887 x 829) x 2	(998 x 1,887 x 829) x 1 + (1,363 x 1,887 x 829) x 2	(1,363 x 1,887 x 829) x 3
Operating Temp. Range	Cooling		°C	-5 ~ 50	-5 ~ 50	-5 ~ 50
	Heating		°C	-25 ~ 24	-25 ~ 24	-25 ~ 24

NOTE

- Specification may be subject to change without prior notice.
- Specification comply with EN14825 and Eurovent test condition
- 1) Performances are based on the following test conditions.
 - Cooling : Indoor temperature 27°CDB, 19°CWB, Outdoor temperature 35°CDB, 24°CWB
 - Heating : Indoor temperature 20°CDB, 15°CWB, Outdoor temperature 7°CDB, 6°CWB
 - Equivalent refrigerant pipe length 5m, Level differences 0m
 - Refer to EUROVENT website(www.eurovent-certification.com) for other indoor unit combination and more detail test conditions.
- 2) Performance of Multiple Module Outdoor unit is weighted average of Single Module outdoor units.
- 3) Allowed combination ratio of the total rated indoor unit capacity over the rated outdoor unit capacity is 50~130%.
- 4) Sound pressure level is obtained in an anechoic room.
 - Sound pressure level is a relative value, depending on the distance and acoustic environment.
 - Sound pressure level may differ depending on operation condition.
 - dBA = A-weighted sound pressure level
 - Reference acoustic pressure 0 dB = 20uPa
- 5) Sound power level is an absolute value that a sound source generates.
 - dBA = A-weighted sound power level
 - Reference power : 1pW
 - Measured according to ISO 3741
- 6) Sound values of multi combination are theoretical values based on sound results of individual installed units.
- 7) These products contain R410A (GWP=2,088) which is fluorinated greenhouse gas.
- 8) If outdoor unit is located in a higher position than indoor unit, level difference is 110m or under.
 - (If the level difference is higher than 50m, make a decision by PDM kit installation Guide software whether the PDM kit should be installed or not.)
 - PDM kit: Pressure Drop Modulation kit
 - When the outdoor unit is below the indoor unit & the level differences are 40m or more, contact your local dealer for more information.
- 9) In case you want to know more information regarding capacity and correction, please refer to capacity table TDB on pvi.samsung.com site.
- 10) Recommended combination

* Ducted

Capacity	Indoor Units	Capacity	Indoor Units
8HP	AM056ANHPKH×4	18HP	AM056ANHPKH×4 + AM071ANHPKH×4
10HP	AM071ANHPKH×4	20HP	AM071ANHPKH×8
12HP	AM056ANHPKH×6	22HP	AM071ANHPKH×4 + AM090ANHPKH×4
14HP	AM056ANHPKH×1 + AM071ANHPKH×5	24HP	AM071ANHPKH×1 + AM090ANLDKH×7
16HP	AM056ANHPKH×2 + AM090ANHPKH×4	26HP	AM090ANLDKH×6 + AM112ANLDKH×2

* Non-ducted

Capacity	Indoor Units	Capacity	Indoor Units
8HP	AM028AN4PKH + AM056AN4PKH×2 + AM090AN4PKH	18HP	AM028AN4PKH + AM056AN4PKH + AM056AN4PKH + AM056AN4PKH×2 + AM090AN4PKH×2 + AM128AN4PKH
10HP	AM056AN4PKH×2 + AM090AN4PKH×2	20HP	AM028AN4PKH + AM056AN4PKH×2 + AM090AN4PKH×2 + AM128AN4PKH
12HP	AM028AN4PKH×2 + AM056AN4PKH×2 + AM090AN4PKH×2	22HP	AM028AN4PKH + AM056AN4PKH + AM056AN4PKH + AM090AN4PKH + AM128AN4PKH
14HP	AM028AN4PKH + AM056AN4PKH + AM056AN4PKH + AM071AN4PKH + AM090AN4PKH + AM128AN4PKH	24HP	AM028AN4PKH×3 + AM128AN4PKH×2 + AM128AN4PKH×3
16HP	AM028AN4PKH + AM056AN4PKH + AM090AN4PKH×3 + AM128AN4PKH	26HP	AM071AN4PKH + AM128AN4PKH×2 + AM128AN4PKH×4

2. Specification

Premium energy efficiency

Model Name				AM680AXVGGH1EU	AM700AXVGGH1EU	AM720AXVGGH1EU
			Outdoor unit module 1	AM200AXVGGH/EU	AM180AXVGGH/EU	AM200AXVGGH/EU
			Outdoor unit module 2	AM220AXVGGH/EU	AM260AXVGGH/EU	AM260AXVGGH/EU
			Outdoor unit module 3	AM260AXVGGH/EU	AM260AXVGGH/EU	AM260AXVGGH/EU
Outdoor unit module 4				-	-	-
Power Supply			Ø, #, V, Hz	3, 4, 380-415, 50	3, 4, 380-415, 50	3, 4, 380-415, 50
Mode			-	HEAT PUMP	HEAT PUMP	HEAT PUMP
Performance	HP		HP	68	70	72
	Capacity	Cooling(Rated)	kW	190.4	196.0	201.6
		Heating(Rated)	kW	185.6	186.4	192.0
		Heating(Max)	kW	214.2	220.5	226.8
Maximum number of connectable indoor units			EA	64	64	64
Total capacity of the connected Indoor Units			Min.	kW	95.2	98.0
			Max.	kW	247.5	254.8
Current	Current Input (Ducted)		Cooling(Rated)	A	140.39	142.01
			Heating(Rated)	A	98.12	111.36
	Current Input (Non-Ducted)		Cooling(Rated)	A	130.75	141.09
			Heating(Rated)	A	113.51	114.42
	Current		Minimum Ssc	MVA	24.6	26.8
			MCA	A	149.0	159.2
MFA			A	175	175	
Efficiency	Ducted		SEER	W/W	-	-
			SCOP	W/W	-	-
			igs.c	%	-	-
			igs.h	%	-	-
	Non_Ducted		SEER	W/W	-	-
			SCOP	W/W	-	-
			igs.c	%	-	-
			igs.h	%	-	-
			Pdesignh	kW	95.9	94.3
Casing	Material		Body	-	GI Steel Plate	GI Steel Plate
			Base	-	GI Steel Plate	GI Steel Plate
Heat Exchanger	Type		-	Fin & Tube	Fin & Tube	Fin & Tube
	Material		Fin	-	Al	Al
			Tube	-	Cu	Cu
	Fin Treatment		-	Anti-corrosion	Anti-corrosion	Anti-corrosion
Compressor	Type		-	Inverter Scroll x 5	Inverter Scroll x 5	Inverter Scroll x 5
	Output		kW x n	(8.93 x 1) x 1 + (6.67 x 2) x 2	(8.93 x 1) x 1 + (6.67 x 2) x 2	(8.93 x 1) x 1 + (6.67 x 2) x 2
	Model Name		-	(DS4GM7090FV* x 1) x 1 + (DS4GR7066FV* x 2) x 2	(DS4GM7090FV* x 1) x 1 + (DS4GR7066FV* x 2) x 2	(DS4GM7090FV* x 1) x 1 + (DS4GR7066FV* x 2) x 2
	Oil		Type	-	PVE	PVE
			Initial charge	cc x n	(1,400 x 1) x 1 + (1,100 x 2) x 2	(1,400 x 1) x 1 + (1,100 x 2) x 2
Fan	Type		-	Propeller	Propeller	Propeller
	Discharge direction		-	Top	Top	Top
	Quantity		EA	6	6	6
	Air Flow Rate		m³/min	313 x 1 + 342 x 1 + 365 x 1	313 x 1 + 365 x 2	313 x 1 + 365 x 2
			l/s	5,209 x 1 + 5,698 x 1 + 6,089 x 1	5,209 x 1 + 6,089 x 2	5,209 x 1 + 6,089 x 2
	External Static Pressure		Max.	mmAq	11	11
			Pa	110	110	110
Fan Motor	Type		-	BLDC Motor	BLDC Motor	BLDC Motor
	Output		W x n	(620 x 2) x 3	(620 x 2) x 3	(620 x 2) x 3
Piping Connections	Liquid Pipe		Type	Braze connection	Braze connection	Braze connection
			Φ, mm (inch)	22.22 (7/8)	22.22 (7/8)	22.22 (7/8)
	Gas Pipe		Type	Braze connection	Braze connection	Braze connection
			Φ, mm (inch)	53.98 (2-1/8)	53.98 (2-1/8)	53.98 (2-1/8)
Heat Insulation		-	Both liquid and gas pipes	Both liquid and gas pipes	Both liquid and gas pipes	

2. Specification

Premium energy efficiency

Model Name				AM680AXVGGH1EU	AM700AXVGGH1EU	AM720AXVGGH1EU
	Outdoor unit module 1			AM200AXVGGH/EU	AM180AXVGGH/EU	AM200AXVGGH/EU
	Outdoor unit module 2			AM220AXVGGH/EU	AM260AXVGGH/EU	AM260AXVGGH/EU
	Outdoor unit module 3			AM260AXVGGH/EU	AM260AXVGGH/EU	AM260AXVGGH/EU
Outdoor unit module 4			-	-	-	
Piping Connections	Piping length (ODU-IDU)	Max. [Equiv.]	m	200[220]	200[220]	200[220]
	Piping length (1st Branch-IDU)	Max.	m	90	90	90
	Total piping length (System)	Max.	m	1,000	1,000	1,000
	Level difference (ODU in highest position)	Max.	m	110	110	110
	Level difference (IDU in highest position)	Max.	m	110	110	110
	Level difference (IDU-IDU)	Max.	m	50	50	50
Wiring connections	Transmission Cable	Min.	mm ²	0.75	0.75	0.75
		Remark	-	F1, F2	F1, F2	F1, F2
	Power supply intake		-	Both indoor and outdoor unit	Both indoor and outdoor unit	Both indoor and outdoor unit
Refrigerant	Type		-	R410A	R410A	R410A
	Factory Charging		kg	10.5 x 2 + 14.0 x 1	10.5 x 1 + 14.0 x 2	10.5 x 1 + 14.0 x 2
			tCO ₂ e		73.08	80.39
Sound [□]	Sound Pressure	Cooling	dB(A)	68	69	69
		Heating	dB(A)	70	71	71
	Sound Power		dB(A)	91	91	91
External Dimension	Net Weight		kg	268 x 1 + 301 x 1 + 325 x 1	268 x 1 + 325 x 2	268 x 1 + 325 x 2
	Shipping Weight		kg	285 x 1 + 318 x 1 + 342 x 1	285 x 1 + 342 x 2	285 x 1 + 342 x 2
	Net Dimensions (WxHxD)		mm	(1,295 x 1,695 x 765) x 3	(1,295 x 1,695 x 765) x 3	(1,295 x 1,695 x 765) x 3
	Shipping Dimensions (WxHxD)		mm	(1,363 x 1,887 x 829) x 3	(1,363 x 1,887 x 829) x 3	(1,363 x 1,887 x 829) x 3
Operating Temp. Range	Cooling		°C	-5 ~ 50	-5 ~ 50	-5 ~ 50
	Heating		°C	-25 ~ 24	-25 ~ 24	-25 ~ 24

NOTE

- Specification may be subject to change without prior notice.
 - Specification comply with EN14825 and Eurovent test condition
- 1) Performances are based on the following test conditions.
 - Cooling : Indoor temperature 27°CDB, 19°CWB, Outdoor temperature 35°CDB, 24°CWB
 - Heating : Indoor temperature 20°CDB, 15°CWB, Outdoor temperature 7°CDB, 6°CWB
 - Equivalent refrigerant pipe length 5m, Level differences 0m
 - Refer to EUROVENT website(www.eurovent-certification.com) for other indoor unit combination and more detail test conditions.
 - 2) Performance of Multiple Module Outdoor unit is weighted average of Single Module outdoor units.
 - 3) Allowed combination ratio of the total rated indoor unit capacity over the rated outdoor unit capacity is 50~130%.
 - 4) Sound pressure level is obtained in an anechoic room.
 - Sound pressure level is a relative value, depending on the distance and acoustic environment.
 - Sound pressure level may differ depending on operation condition.
 - dBA = A-weighted sound pressure level
 - Reference acoustic pressure 0 dB = 20uPa
 - 5) Sound power level is an absolute value that a sound source generates.
 - dBA = A-weighted sound power level
 - Reference power : 1pW
 - Measured according to ISO 3741
 - 6) Sound values of multi combination are theoretical values based on sound results of individual installed units.
 - 7) These products contain R410A (GWP=2,088) which is fluorinated greenhouse gas.
 - 8) If outdoor unit is located in a higher position than indoor unit, level difference is 110m or under.
 - (If the level difference is higher than 50m, make a decision by PDM kit installation Guide software whether the PDM kit should be installed or not.)
 - PDM kit: Pressure Drop Modulation kit
 - When the outdoor unit is below the indoor unit & the level differences are 40m or more, contact your local dealer for more information.
 - 9) In case you want to know more information regarding capacity and correction, please refer to capacity table TDB on pvi.samsung.com site.
 - 10) Recommended combination

* Ducted

Capacity	Indoor Units	Capacity	Indoor Units
8HP	AM056ANHPKH×4	18HP	AM056ANHPKH×4 + AM071ANHPKH×4
10HP	AM071ANHPKH×4	20HP	AM071ANHPKH×8
12HP	AM056ANHPKH×6	22HP	AM071ANHPKH×4 + AM090ANHPKH×4
14HP	AM056ANHPKH×1 + AM071ANHPKH×5	24HP	AM071ANHPKH×1 + AM090ANLDKH×7
16HP	AM056ANHPKH×2 + AM090ANHPKH×4	26HP	AM090ANLDKH×6 + AM112ANLDKH×2

* Non-ducted

Capacity	Indoor Units	Capacity	Indoor Units
8HP	AM028AN4PKH + AM056AN4PKH×2 + AM090AN4PKH	18HP	AM028AN4PKH + AM056AN4PKH + AM056AN4PKH + AM056AN4PKH×2 + AM090AN4PKH×2 + AM128AN4PKH
10HP	AM056AN4PKH×2 + AM090AN4PKH×2	20HP	AM028AN4PKH + AM056AN4PKH×2 + AM090AN4PKH×2 + AM128AN4PKH
12HP	AM028AN4PKH×2 + AM056AN4PKH×2 + AM090AN4PKH×2	22HP	AM028AN4PKH + AM056AN4PKH + AM056AN4PKH + AM090AN4PKH×2 + AM128AN4PKH
14HP	AM028AN4PKH + AM056AN4PKH + AM056AN4PKH + AM071AN4PKH + AM090AN4PKH + AM128AN4PKH	24HP	AM028AN4PKH + AM128AN4PKH×2 + AM128AN4PKH×3
16HP	AM028AN4PKH + AM056AN4PKH + AM090AN4PKH×3 + AM128AN4PKH	26HP	AM071AN4PKH + AM128AN4PKH + AM128AN4PKH×4

2. Specification

Premium energy efficiency

Model Name				AM740AXVGGH1EU	AM760AXVGGH1EU	AM780AXVGGH1EU
			Outdoor unit module 1	AM220AXVGGH/EU	AM240AXVGGH/EU	AM260AXVGGH/EU
			Outdoor unit module 2	AM260AXVGGH/EU	AM260AXVGGH/EU	AM260AXVGGH/EU
			Outdoor unit module 3	AM260AXVGGH/EU	AM260AXVGGH/EU	AM260AXVGGH/EU
Outdoor unit module 4			-	-	-	-
Power Supply			Ø, #, V, Hz	3, 4, 380-415, 50	3, 4, 380-415, 50	3, 4, 380-415, 50
Mode			-	HEAT PUMP	HEAT PUMP	HEAT PUMP
Performance	HP		HP	74	76	78
	Capacity	Cooling(Rated)	kW	207.2	212.8	218.4
		Heating(Rated)	kW	197.6	203.2	204.0
		Heating(Max)	kW	233.1	239.4	245.7
Maximum number of connectable indoor units			EA	64	64	64
Total capacity of the connected Indoor Units			Min.	kW	103.6	106.4
			Max.	kW	269.4	276.6
Current	Current Input (Ducted)		Cooling(Rated)	A	159.37	163.84
			Heating(Rated)	A	117.51	134.42
	Current Input (Non-Ducted)		Cooling(Rated)	A	152.15	162.49
			Heating(Rated)	A	133.51	134.42
	Current		Minimum Ssc	MVA	27.8	29.7
			MCA	A	166.0	175.0
MFA			A	200	200	
Efficiency	Ducted		SEER	W/W	-	-
			SCOP	W/W	-	-
			igs.c	%	-	-
			igs.h	%	-	-
	Non_Ducted		SEER	W/W	-	-
			SCOP	W/W	-	-
			igs.c	%	-	-
			igs.h	%	-	-
			Pdesignh	kW	97.8	98.4
Casing	Material		Body	-	GI Steel Plate	GI Steel Plate
			Base	-	GI Steel Plate	GI Steel Plate
Heat Exchanger	Type		-	Fin & Tube	Fin & Tube	Fin & Tube
	Material		Fin	-	Al	Al
			Tube	-	Cu	Cu
	Fin Treatment		-	Anti-corrosion	Anti-corrosion	Anti-corrosion
Compressor	Type		-	Inverter Scroll x 6	Inverter Scroll x 6	Inverter Scroll x 6
	Output		kW x n	(6.67 x 2) x 3	(6.67 x 2) x 3	(6.67 x 2) x 3
	Model Name		-	(DS4GR7066FV* x 2) x 3	(DS4GR7066FV* x 2) x 3	(DS4GR7066FV* x 2) x 3
	Oil		Type	-	PVE	PVE
			Initial charge	cc x n	(1,100 x 2) x 3	(1,100 x 2) x 3
Fan	Type		-	Propeller	Propeller	Propeller
	Discharge direction		-	Top	Top	Top
	Quantity		EA	6	6	6
	Air Flow Rate		m³/min	342 x 1 + 365 x 2	365 x 3	365 x 3
			l/s	5,698 x 1 + 6,089 x 2	6,089 x 3	6,089 x 3
	External Static Pressure		Max.	mmAq	11	8
				Pa	110	80
Fan Motor	Type		-	BLDC Motor	BLDC Motor	
	Output		W x n	(620 x 2) x 3	(620 x 2) x 3	
Piping Connections	Liquid Pipe		Type	Braze connection	Braze connection	
			Φ, mm (inch)	22.22 (7/8)	22.22 (7/8)	
	Gas Pipe		Type	Braze connection	Braze connection	
			Φ, mm (inch)	53.98 (2-1/8)	53.98 (2-1/8)	
Heat Insulation		-	Both liquid and gas pipes	Both liquid and gas pipes		

2. Specification

Premium energy efficiency

Model Name				AM740AXVGGH1EU	AM760AXVGGH1EU	AM780AXVGGH1EU
	Outdoor unit module 1			AM220AXVGGH/EU	AM240AXVGGH/EU	AM260AXVGGH/EU
	Outdoor unit module 2			AM260AXVGGH/EU	AM260AXVGGH/EU	AM260AXVGGH/EU
	Outdoor unit module 3			AM260AXVGGH/EU	AM260AXVGGH/EU	AM260AXVGGH/EU
Outdoor unit module 4			-	-	-	
Piping Connections	Piping length (ODU-IDU)	Max. [Equiv.]	m	200[220]	200[220]	200[220]
	Piping length (1st Branch-IDU)	Max.	m	90	90	90
	Total piping length (System)	Max.	m	1,000	1,000	1,000
	Level difference (ODU in highest position)	Max.	m	110	110	110
	Level difference (IDU in highest position)	Max.	m	110	110	110
	Level difference (IDU-IDU)	Max.	m	50	50	50
Wiring connections	Transmission Cable	Min.	mm ²	0.75	0.75	0.75
		Remark	-	F1, F2	F1, F2	F1, F2
	Power supply intake		-	Both indoor and outdoor unit	Both indoor and outdoor unit	Both indoor and outdoor unit
Refrigerant	Type		-	R410A	R410A	R410A
	Factory Charging		kg	10.5 x 1 + 14.0 x 2	14.0 x 3	14.0 x 3
			tCO ₂ e		80.39	87.70
Sound	Sound Pressure	Cooling	dB(A)	69	70	70
		Heating	dB(A)	71	72	72
	Sound Power		dB(A)	91	92	92
External Dimension	Net Weight		kg	301 x 1 + 325 x 2	325 x 3	325 x 3
	Shipping Weight		kg	318 x 1 + 342 x 2	342 x 3	342 x 3
	Net Dimensions (WxHxD)		mm	(1,295 x 1,695 x 765) x 3	(1,295 x 1,695 x 765) x 3	(1,295 x 1,695 x 765) x 3
	Shipping Dimensions (WxHxD)		mm	(1,363 x 1,887 x 829) x 3	(1,363 x 1,887 x 829) x 3	(1,363 x 1,887 x 829) x 3
Operating Temp. Range	Cooling		°C	-5 ~ 50	-5 ~ 50	-5 ~ 50
	Heating		°C	-25 ~ 24	-25 ~ 24	-25 ~ 24

NOTE

- Specification may be subject to change without prior notice.
 - Specification comply with EN14825 and Eurovent test condition
- 1) Performances are based on the following test conditions.
 - Cooling : Indoor temperature 27°CDB, 19°CWB, Outdoor temperature 35°CDB, 24°CWB
 - Heating : Indoor temperature 20°CDB, 15°CWB, Outdoor temperature 7°CDB, 6°CWB
 - Equivalent refrigerant pipe length 5m, Level differences 0m
 - Refer to EUROVENT website(www.eurovent-certification.com) for other indoor unit combination and more detail test conditions.
 - 2) Performance of Multiple Module Outdoor unit is weighted average of Single Module outdoor units.
 - 3) Allowed combination ratio of the total rated indoor unit capacity over the rated outdoor unit capacity is 50~130%.
 - 4) Sound pressure level is obtained in an anechoic room.
 - Sound pressure level is a relative value, depending on the distance and acoustic environment.
 - Sound pressure level may differ depending on operation condition.
 - dBA = A-weighted sound pressure level
 - Reference acoustic pressure 0 dB = 20uPa
 - 5) Sound power level is an absolute value that a sound source generates.
 - dBA = A-weighted sound power level
 - Reference power : 1pW
 - Measured according to ISO 3741
 - 6) Sound values of multi combination are theoretical values based on sound results of individual installed units.
 - 7) These products contain R410A (GWP=2,088) which is fluorinated greenhouse gas.
 - 8) If outdoor unit is located in a higher position than indoor unit, level difference is 110m or under.
 - (If the level difference is higher than 50m, make a decision by PDM kit installation Guide software whether the PDM kit should be installed or not.)
 - PDM kit: Pressure Drop Modulation kit
 - When the outdoor unit is below the indoor unit & the level differences are 40m or more, contact your local dealer for more information.
 - 9) In case you want to know more information regarding capacity and correction, please refer to capacity table TDB on pvi.samsung.com site.
 - 10) Recommended combination

* Ducted

Capacity	Indoor Units	Capacity	Indoor Units
8HP	AM056ANHPKH×4	18HP	AM056ANHPKH×4 + AM071ANHPKH×4
10HP	AM071ANHPKH×4	20HP	AM071ANHPKH×8
12HP	AM056ANHPKH×6	22HP	AM071ANHPKH×4 + AM090ANHPKH×4
14HP	AM056ANHPKH×1 + AM071ANHPKH×5	24HP	AM071ANHPKH×1 + AM090ANLDKH×7
16HP	AM056ANHPKH×2 + AM090ANHPKH×4	26HP	AM090ANLDKH×6 + AM112ANLDKH×2

* Non-ducted

Capacity	Indoor Units	Capacity	Indoor Units
8HP	AM028AN4PKH + AM056AN4PKH×2 + AM090AN4PKH	18HP	AM028AN4PKH + AM056AN4PKH + AM056AN4PKH + AM056AN4PKH×2 + AM090AN4PKH×2 + AM071AN4PKH
10HP	AM056AN4PKH×2 + AM090AN4PKH×2	20HP	AM028AN4PKH + AM056AN4PKH×2 + AM090AN4PKH×2 + AM071AN4PKH
12HP	AM028AN4PKH×2 + AM056AN4PKH×2 + AM090AN4PKH×2	22HP	AM028AN4PKH + AM056AN4PKH + AM056AN4PKH + AM090AN4PKH×2 + AM071AN4PKH
14HP	AM028AN4PKH + AM056AN4PKH + AM056AN4PKH + AM071AN4PKH + AM090AN4PKH + AM128AN4PKH	24HP	AM071AN4PKH + AM128AN4PKH×2 + AM128AN4PKH×3
16HP	AM028AN4PKH + AM056AN4PKH + AM090AN4PKH×3 + AM128AN4PKH	26HP	AM071AN4PKH + AM128AN4PKH + AM128AN4PKH×4

2. Specification

Premium energy efficiency

Model Name				AM800AXVGGH1EU	AM820AXVGGH1EU	AM840AXVGGH1EU	
			Outdoor unit module 1		AM140AXVGGH/EU	AM160AXVGGH/EU	AM180AXVGGH/EU
			Outdoor unit module 2		AM200AXVGGH/EU	AM200AXVGGH/EU	AM200AXVGGH/EU
			Outdoor unit module 3		AM200AXVGGH/EU	AM200AXVGGH/EU	AM200AXVGGH/EU
Outdoor unit module 4				AM260AXVGGH/EU	AM260AXVGGH/EU	AM260AXVGGH/EU	
Power Supply			Ø, #, V, Hz	3, 4, 380-415, 50	3, 4, 380-415, 50	3, 4, 380-415, 50	
Mode			-	HEAT PUMP	HEAT PUMP	HEAT PUMP	
Performance	HP		HP	80	82	84	
	Capacity	Cooling(Rated)	kW	224.8	229.8	235.2	
		Heating(Rated)	kW	220.0	225.0	230.4	
		Heating(Max)	kW	252.9	258.3	264.6	
Maximum number of connectable indoor units			EA	64	64	64	
Total capacity of the connected Indoor Units			Min.	kW	112.4	114.9	
			Max.	kW	292.2	298.7	305.8
Current	Current Input (Ducted)	Cooling(Rated)	A	160.31	161.83	161.66	
		Heating(Rated)	A	113.61	115.90	117.69	
	Current Input (Non-Ducted)	Cooling(Rated)	A	154.93	155.65	165.99	
		Heating(Rated)	A	125.25	143.43	144.34	
	Current	Minimum Ssc	MVA	28.6	29.4	30.6	
		MCA	A	173.0	178.0	185.2	
MFA		A	200	200	225		
Efficiency	SEER	Ducted	W/W	-	-	-	
	SCOP		W/W	-	-	-	
	igs.c		%	-	-	-	
	igs.h		%	-	-	-	
	SEER	Non_Ducted	W/W	-	-	-	
	SCOP		W/W	-	-	-	
	igs.c		%	-	-	-	
	igs.h		%	-	-	-	
	Pdesignh		kW	117.8	120.2	123.5	
Casing	Material	Body	-	GI Steel Plate	GI Steel Plate	GI Steel Plate	
		Base	-	GI Steel Plate	GI Steel Plate	GI Steel Plate	
Heat Exchanger	Type		-	Fin & Tube	Fin & Tube	Fin & Tube	
	Material	Fin	-	Al	Al	Al	
		Tube	-	Cu	Cu	Cu	
	Fin Treatment		-	Anti-corrosion	Anti-corrosion	Anti-corrosion	
Compressor	Type		-	Inverter Scroll x 5	Inverter Scroll x 5	Inverter Scroll x 5	
	Output		kW x n	(6.67 x 1) x 1 + (8.93 x 1) x 2 + (6.67 x 2) x 1	(8.93 x 1) x 3 + (6.67 x 2) x 1	(8.93 x 1) x 3 + (6.67 x 2) x 1	
	Model Name		-	(DS4GR7066FV* x 1) x 1 + (DS4GM7090FV* x 1) x 2 + (DS4GR7066FV* x 2) x 1	(DS4GM7090FV* x 1) x 3 + (DS4GR7066FV* x 2) x 1	(DS4GM7090FV* x 1) x 3 + (DS4GR7066FV* x 2) x 1	
	Oil	Type	-	PVE	PVE	PVE	
Initial charge		cc x n	(1,100 x 1) x 1 + (1,400 x 1) x 2 + (1,100 x 2) x 1	(1,400 x 1) x 3 + (1,100 x 2) x 1	(1,400 x 1) x 3 + (1,100 x 2) x 1		
Fan	Type		-	Propeller	Propeller	Propeller	
	Discharge direction		-	Top	Top	Top	
	Quantity		EA	8	8	8	
	Air Flow Rate		m³/min	291 x 1 + 313 x 2 + 365 x 1	292 x 1 + 313 x 2 + 365 x 1	313 x 3 + 365 x 1	
			l/s	4,852 x 1 + 5,209 x 2 + 6,089 x 1	4,866 x 1 + 5,209 x 2 + 6,089 x 1	5,209 x 3 + 6,089 x 1	
	External Static Pressure	Max.	mmAq	11	11	11	
Pa			110	110	110		
Fan Motor	Type		-	BLDC Motor	BLDC Motor	BLDC Motor	
	Output		W x n	(620 x 2) x 4	(620 x 2) x 4	(620 x 2) x 4	
Piping Connections	Liquid Pipe		Type	Braze connection	Braze connection	Braze connection	
			Φ, mm (inch)	22.22 (7/8)	22.22 (7/8)	22.22 (7/8)	
	Gas Pipe		Type	Braze connection	Braze connection	Braze connection	
			Φ, mm (inch)	53.98 (2-1/8)	53.98 (2-1/8)	53.98 (2-1/8)	
Heat Insulation		-	Both liquid and gas pipes	Both liquid and gas pipes	Both liquid and gas pipes		

2. Specification

Premium energy efficiency

Model Name	Outdoor unit module 1			AM800AXVGGH1EU	AM820AXVGGH1EU	AM840AXVGGH1EU
	Outdoor unit module 2			AM140AXVGGH/EU	AM160AXVGGH/EU	AM180AXVGGH/EU
	Outdoor unit module 3			AM200AXVGGH/EU	AM200AXVGGH/EU	AM200AXVGGH/EU
	Outdoor unit module 4			AM260AXVGGH/EU	AM260AXVGGH/EU	AM260AXVGGH/EU
Piping Connections	Piping length (ODU-IDU)	Max. [Equiv.]	m	200[220]	200[220]	200[220]
	Piping length (1st Branch-IDU)	Max.	m	90	90	90
	Total piping length (System)	Max.	m	1,000	1,000	1,000
	Level difference (ODU in highest position)	Max.	m	110	110	110
	Level difference (IDU in highest position)	Max.	m	110	110	110
	Level difference (IDU-IDU)	Max.	m	50	50	50
Wiring connections	Transmission Cable	Min.	mm ²	0.75	0.75	0.75
		Remark	-	F1, F2	F1, F2	F1, F2
	Power supply intake		-	Both indoor and outdoor unit	Both indoor and outdoor unit	Both indoor and outdoor unit
Refrigerant	Type		-	R410A	R410A	R410A
	Factory Charging		kg	8.0 x 1 + 10.5 x 2 + 14.0 x 1	10.5 x 3 + 14.0 x 1	10.5 x 3 + 14.0 x 1
			tCO ₂ e	89.78	95.00	95.00
Sound	Sound Pressure	Cooling	dB(A)	68	68	68
		Heating	dB(A)	70	70	70
	Sound Power		dB(A)	91	91	91
External Dimension	Net Weight		kg	233 x 1 + 268 x 2 + 325 x 1	262 x 1 + 268 x 2 + 325 x 1	268 x 3 + 325 x 1
	Shipping Weight		kg	250 x 1 + 285 x 2 + 342 x 1	279 x 1 + 285 x 2 + 342 x 1	285 x 3 + 342 x 1
	Net Dimensions (WxHxD)		mm	(1,295 x 1,695 x 765) x 4	(1,295 x 1,695 x 765) x 4	(1,295 x 1,695 x 765) x 4
	Shipping Dimensions (WxHxD)		mm	(1,363 x 1,887 x 829) x 4	(1,363 x 1,887 x 829) x 4	(1,363 x 1,887 x 829) x 4
Operating Temp. Range	Cooling		°C	-5 ~ 50	-5 ~ 50	-5 ~ 50
	Heating		°C	-25 ~ 24	-25 ~ 24	-25 ~ 24

NOTE

- Specification may be subject to change without prior notice.
- Specification comply with EN14825 and Eurovent test condition
- 1) Performances are based on the following test conditions.
 - Cooling : Indoor temperature 27°CDB, 19°CWB, Outdoor temperature 35°CDB, 24°CWB
 - Heating : Indoor temperature 20°CDB, 15°CWB, Outdoor temperature 7°CDB, 6°CWB
 - Equivalent refrigerant pipe length 5m, Level differences 0m
 - Refer to EUROVENT website(www.eurovent-certification.com) for other indoor unit combination and more detail test conditions.
- 2) Performance of Multiple Module Outdoor unit is weighted average of Single Module outdoor units.
- 3) Allowed combination ratio of the total rated indoor unit capacity over the rated outdoor unit capacity is 50~130%.
- 4) Sound pressure level is obtained in an anechoic room.
 - Sound pressure level is a relative value, depending on the distance and acoustic environment.
 - Sound pressure level may differ depending on operation condition.
 - dBA = A-weighted sound pressure level
 - Reference acoustic pressure 0 dB = 20uPa
- 5) Sound power level is an absolute value that a sound source generates.
 - dBA = A-weighted sound power level
 - Reference power: 1pW
 - Measured according to ISO 3741
- 6) Sound values of multi combination are theoretical values based on sound results of individual installed units.
- 7) These products contain R410A (GWP=2,088) which is fluorinated greenhouse gas.
- 8) If outdoor unit is located in a higher position than indoor unit, level difference is 110m or under.
 - (If the level difference is higher than 50m, make a decision by PDM kit installation Guide software whether the PDM kit should be installed or not.)
 - PDM kit: Pressure Drop Modulation kit
 - When the outdoor unit is below the indoor unit & the level differences are 40m or more, contact your local dealer for more information.
- 9) In case you want to know more information regarding capacity and correction, please refer to capacity table TDB on pvi.samsung.com site.
- 10) Recommended combination

* Ducted

Capacity	Indoor Units	Capacity	Indoor Units
8HP	AM056ANHPKH×4	18HP	AM056ANHPKH×4 + AM071ANHPKH×4
10HP	AM071ANHPKH×4	20HP	AM071ANHPKH×8
12HP	AM056ANHPKH×6	22HP	AM071ANHPKH×4 + AM090ANHPKH×4
14HP	AM056ANHPKH×1 + AM071ANHPKH×5	24HP	AM071ANHPKH×1 + AM090ANLDKH×7
16HP	AM056ANHPKH×2 + AM090ANHPKH×4	26HP	AM090ANLDKH×6 + AM112ANLDKH×2

* Non-ducted

Capacity	Indoor Units	Capacity	Indoor Units
8HP	AM028AN4PKH + AM056AN4PKH×2 + AM090AN4PKH	18HP	AM028AN4PKH + AM056AN4PKH + AM056AN4PKH + AM056AN4PKH×2 + AM090AN4PKH×2 + AM128AN4PKH
10HP	AM056AN4PKH×2 + AM090AN4PKH×2	20HP	AM028AN4PKH + AM056AN4PKH×2 + AM090AN4PKH×2 + AM128AN4PKH
12HP	AM028AN4PKH×2 + AM056AN4PKH×2 + AM090AN4PKH×2	22HP	AM028AN4PKH + AM056AN4PKH + AM056AN4PKH + AM090AN4PKH + AM128AN4PKH
14HP	AM028AN4PKH + AM056AN4PKH + AM056AN4PKH + AM071AN4PKH + AM090AN4PKH + AM128AN4PKH	24HP	AM028AN4PKH×3 + AM128AN4PKH×2 + AM128AN4PKH×3
16HP	AM028AN4PKH + AM056AN4PKH + AM090AN4PKH×3 + AM128AN4PKH	26HP	AM071AN4PKH + AM128AN4PKH + AM128AN4PKH×4

2. Specification

Premium energy efficiency

Model Name				AM860AXVGGH1EU	AM880AXVGGH1EU	AM900AXVGGH1EU
			Outdoor unit module 1	AM200AXVGGH/EU	AM180AXVGGH/EU	AM180AXVGGH/EU
			Outdoor unit module 2	AM200AXVGGH/EU	AM180AXVGGH/EU	AM200AXVGGH/EU
			Outdoor unit module 3	AM200AXVGGH/EU	AM260AXVGGH/EU	AM260AXVGGH/EU
Outdoor unit module 4			AM260AXVGGH/EU	AM260AXVGGH/EU	AM260AXVGGH/EU	AM260AXVGGH/EU
Power Supply			Ø, #, V, Hz	3, 4, 380-415, 50	3, 4, 380-415, 50	3, 4, 380-415, 50
Mode			-	HEAT PUMP	HEAT PUMP	HEAT PUMP
Performance	HP		HP	86	88	90
	Capacity	Cooling(Rated)	kW	240.8	246.4	252.0
		Heating(Rated)	kW	236.0	236.8	242.4
		Heating(Max)	kW	270.9	277.2	283.5
Maximum number of connectable indoor units			EA	64	64	64
Total capacity of the connected Indoor Units			Min.	kW	120.4	123.2
			Max.	kW	313.0	320.3
Current	Current Input (Ducted)		Cooling(Rated)	A	173.50	168.80
			Heating(Rated)	A	122.27	132.50
	Current Input (Non-Ducted)		Cooling(Rated)	A	176.33	186.67
			Heating(Rated)	A	145.25	146.16
	Current		Minimum Ssc	MVA	31.2	33.2
			MCA	A	189.0	198.4
MFA			A	225	225	
Efficiency	SEER		Ducted	W/W	-	-
				W/W	-	-
				%	-	-
	SCOP		Ducted	W/W	-	-
				W/W	-	-
				%	-	-
	SEER		Non_Ducted	W/W	-	-
				W/W	-	-
				%	-	-
SCOP		Non_Ducted	W/W	-	-	
			W/W	-	-	
			%	-	-	
Pdesignh			kW	126.3	122.6	125.4
Casing	Material		Body	-	GI Steel Plate	GI Steel Plate
			Base	-	GI Steel Plate	GI Steel Plate
Heat Exchanger	Type		-	Fin & Tube	Fin & Tube	Fin & Tube
	Material		Fin	-	Al	Al
			Tube	-	Cu	Cu
	Fin Treatment		-	Anti-corrosion	Anti-corrosion	Anti-corrosion
Compressor	Type		-	Inverter Scroll x 5	Inverter Scroll x 6	Inverter Scroll x 6
	Output		kW x n	(8.93 x 1) x 3 + (6.67 x 2) x 1	(8.93 x 1) x 2 + (6.67 x 2) x 2	(8.93 x 1) x 2 + (6.67 x 2) x 2
	Model Name		-	(DS4GM7090FV* x 1) x 3 + (DS4GR7066FV* x 2) x 1	(DS4GM7090FV* x 1) x 2 + (DS4GR7066FV* x 2) x 2	(DS4GM7090FV* x 1) x 2 + (DS4GR7066FV* x 2) x 2
	Oil		Type	-	PVE	PVE
Initial charge			cc x n	(1,400 x 1) x 3 + (1,100 x 2) x 1	(1,400 x 1) x 2 + (1,100 x 2) x 2	(1,400 x 1) x 2 + (1,100 x 2) x 2
Fan	Type		-	Propeller	Propeller	Propeller
	Discharge direction		-	Top	Top	Top
	Quantity		EA	8	8	8
	Air Flow Rate		m ³ /min	313 x 3 + 365 x 1	313 x 2 + 365 x 2	313 x 2 + 365 x 2
			l/s	5,209 x 3 + 6,089 x 1	5,209 x 2 + 6,089 x 2	5,209 x 2 + 6,089 x 2
	External Static Pressure		Max.	mmAq	11	11
Pa				110	110	
Fan Motor	Type		-	BLDC Motor	BLDC Motor	BLDC Motor
	Output		W x n	(620 x 2) x 4	(620 x 2) x 4	(620 x 2) x 4
Piping Connections	Liquid Pipe		Type	Braze connection	Braze connection	Braze connection
			Φ, mm (inch)	22.22 (7/8)	22.22 (7/8)	22.22 (7/8)
	Gas Pipe		Type	Braze connection	Braze connection	Braze connection
			Φ, mm (inch)	53.98 (2-1/8)	53.98 (2-1/8)	53.98 (2-1/8)
Heat Insulation		-	Both liquid and gas pipes	Both liquid and gas pipes	Both liquid and gas pipes	

2. Specification

Premium energy efficiency

Model Name				AM860AXVGGH1EU	AM880AXVGGH1EU	AM900AXVGGH1EU
	Outdoor unit module 1			AM200AXVGGH/EU	AM180AXVGGH/EU	AM180AXVGGH/EU
	Outdoor unit module 2			AM200AXVGGH/EU	AM180AXVGGH/EU	AM200AXVGGH/EU
	Outdoor unit module 3			AM200AXVGGH/EU	AM260AXVGGH/EU	AM260AXVGGH/EU
Outdoor unit module 4			AM260AXVGGH/EU	AM260AXVGGH/EU	AM260AXVGGH/EU	
Piping Connections	Piping length (ODU-IDU)	Max. [Equiv.]	m	200[220]	200[220]	200[220]
	Piping length (1st Branch-IDU)	Max.	m	90	90	90
	Total piping length (System)	Max.	m	1,000	1,000	1,000
	Level difference (ODU in highest position)	Max.	m	110	110	110
	Level difference (IDU in highest position)	Max.	m	110	110	110
	Level difference (IDU-IDU)	Max.	m	50	50	50
Wiring connections	Transmission Cable	Min.	mm ²	0.75	0.75	0.75
		Remark	-	F1, F2	F1, F2	F1, F2
	Power supply intake		-	Both indoor and outdoor unit	Both indoor and outdoor unit	Both indoor and outdoor unit
Refrigerant	Type		-	R410A	R410A	R410A
	Factory Charging		kg	10.5 x 3 + 14.0 x 1	10.5 x 2 + 14.0 x 2	10.5 x 2 + 14.0 x 2
			tCO ₂ e	95.00	102.31	102.31
Sound	Sound Pressure	Cooling	dB(A)	68	69	69
		Heating	dB(A)	70	71	71
	Sound Power			dB(A)	91	91
External Dimension	Net Weight		kg	268 x 3 + 325 x 1	268 x 2 + 325 x 2	268 x 2 + 325 x 2
	Shipping Weight		kg	285 x 3 + 342 x 1	285 x 2 + 342 x 2	285 x 2 + 342 x 2
	Net Dimensions (WxHxD)		mm	(1,295 x 1,695 x 765) x 4	(1,295 x 1,695 x 765) x 4	(1,295 x 1,695 x 765) x 4
	Shipping Dimensions (WxHxD)		mm	(1,363 x 1,887 x 829) x 4	(1,363 x 1,887 x 829) x 4	(1,363 x 1,887 x 829) x 4
Operating Temp. Range	Cooling		°C	-5 ~ 50	-5 ~ 50	-5 ~ 50
	Heating		°C	-25 ~ 24	-25 ~ 24	-25 ~ 24

NOTE

- Specification may be subject to change without prior notice.
 - Specification comply with EN14825 and Eurovent test condition
- 1) Performances are based on the following test conditions.
 - Cooling : Indoor temperature 27°CDB, 19°CWB, Outdoor temperature 35°CDB, 24°CWB
 - Heating : Indoor temperature 20°CDB, 15°CWB, Outdoor temperature 7°CDB, 6°CWB
 - Equivalent refrigerant pipe length 5m, Level differences 0m
 - Refer to EUROVENT website(www.eurovent-certification.com) for other indoor unit combination and more detail test conditions.
 - 2) Performance of Multiple Module Outdoor unit is weighted average of Single Module outdoor units.
 - 3) Allowed combination ratio of the total rated indoor unit capacity over the rated outdoor unit capacity is 50~130%.
 - 4) Sound pressure level is obtained in an anechoic room.
 - Sound pressure level is a relative value, depending on the distance and acoustic environment.
 - Sound pressure level may differ depending on operation condition.
 - dBA = A-weighted sound pressure level
 - Reference acoustic pressure 0 dB = 20uPa
 - 5) Sound power level is an absolute value that a sound source generates.
 - dBA = A-weighted sound power level
 - Reference power : 1pW
 - Measured according to ISO 3741
 - 6) Sound values of multi combination are theoretical values based on sound results of individual installed units.
 - 7) These products contain R410A (GWP=2,088) which is fluorinated greenhouse gas.
 - 8) If outdoor unit is located in a higher position than indoor unit, level difference is 110m or under.
 - (If the level difference is higher than 50m, make a decision by PDM kit installation Guide software whether the PDM kit should be installed or not.)
 - PDM kit: Pressure Drop Modulation kit
 - When the outdoor unit is below the indoor unit & the level differences are 40m or more, contact your local dealer for more information.
 - 9) In case you want to know more information regarding capacity and correction, please refer to capacity table TDB on pvi.samsung.com site.
 - 10) Recommended combination

* Ducted

Capacity	Indoor Units	Capacity	Indoor Units
8HP	AM056ANHPKH×4	18HP	AM056ANHPKH×4 + AM071ANHPKH×4
10HP	AM071ANHPKH×4	20HP	AM071ANHPKH×8
12HP	AM056ANHPKH×6	22HP	AM071ANHPKH×4 + AM090ANHPKH×4
14HP	AM056ANHPKH×1 + AM071ANHPKH×5	24HP	AM071ANHPKH×1 + AM090ANLDKH×7
16HP	AM056ANHPKH×2 + AM090ANHPKH×4	26HP	AM090ANLDKH×6 + AM112ANLDKH×2

* Non-ducted

Capacity	Indoor Units	Capacity	Indoor Units
8HP	AM028AN4PKH + AM056AN4PKH×2 + AM090AN4PKH	18HP	AM028AN4PKH + AM056AN4PKH + AM056AN4PKH + AM056AN4PKH×2 + AM090AN4PKH×2 + AM128AN4PKH
10HP	AM056AN4PKH×2 + AM090AN4PKH×2	20HP	AM028AN4PKH + AM056AN4PKH×2 + AM090AN4PKH×2 + AM128AN4PKH
12HP	AM028AN4PKH×2 + AM056AN4PKH×2 + AM090AN4PKH×2	22HP	AM028AN4PKH + AM056AN4PKH + AM056AN4PKH + AM090AN4PKH + AM128AN4PKH
14HP	AM028AN4PKH + AM056AN4PKH + AM056AN4PKH + AM071AN4PKH + AM090AN4PKH + AM128AN4PKH	24HP	AM071AN4PKH + AM128AN4PKH×2 + AM128AN4PKH×3
16HP	AM028AN4PKH + AM056AN4PKH + AM090AN4PKH×3 + AM128AN4PKH	26HP	AM071AN4PKH + AM128AN4PKH + AM128AN4PKH×4

2. Specification

Premium energy efficiency

Model Name				AM920AXVGGH1EU	AM940AXVGGH1EU	AM960AXVGGH1EU	
			Outdoor unit module 1		AM200AXVGGH/EU	AM200AXVGGH/EU	AM180AXVGGH/EU
			Outdoor unit module 2		AM200AXVGGH/EU	AM220AXVGGH/EU	AM260AXVGGH/EU
			Outdoor unit module 3		AM260AXVGGH/EU	AM260AXVGGH/EU	AM260AXVGGH/EU
Outdoor unit module 4				AM260AXVGGH/EU	AM260AXVGGH/EU	AM260AXVGGH/EU	
Power Supply			Ø, #, V, Hz	3, 4, 380-415, 50	3, 4, 380-415, 50	3, 4, 380-415, 50	
Mode			-	HEAT PUMP	HEAT PUMP	HEAT PUMP	
Performance	HP		HP	92	94	96	
	Capacity	Cooling(Rated)	kW	257.6	263.2	268.8	
		Heating(Rated)	kW	248.0	253.6	254.4	
		Heating(Max)	kW	289.8	296.1	302.4	
Maximum number of connectable indoor units			EA	64	64	64	
Total capacity of the connected Indoor Units			Min.	kW	128.8	131.6	
			Max.	kW	334.9	342.2	349.4
Current	Current Input (Ducted)	Cooling(Rated)	A	192.48	198.00	199.62	
		Heating(Rated)	A	141.66	143.23	156.47	
	Current Input (Non-Ducted)	Cooling(Rated)	A	178.02	188.36	189.08	
		Heating(Rated)	A	157.71	158.62	176.80	
	Current	Minimum Ssc	MVA	34.4	34.8	37.0	
		MCA	A	206.0	209.0	219.2	
MFA		A	250	250	250		
Efficiency	SEER	Ducted	W/W	-	-	-	
			W/W	-	-	-	
			%	-	-	-	
			%	-	-	-	
	SEER	Non_Ducted	W/W	-	-	-	
			W/W	-	-	-	
			%	-	-	-	
			%	-	-	-	
	Pdesignh			kW	128.2	128.9	127.3
Casing	Material	Body	-	GI Steel Plate	GI Steel Plate	GI Steel Plate	
		Base	-	GI Steel Plate	GI Steel Plate	GI Steel Plate	
Heat Exchanger	Type		-	Fin & Tube	Fin & Tube	Fin & Tube	
	Material	Fin	-	Al	Al	Al	
		Tube	-	Cu	Cu	Cu	
	Fin Treatment		-	Anti-corrosion	Anti-corrosion	Anti-corrosion	
Compressor	Type		-	Inverter Scroll x 6	Inverter Scroll x 7	Inverter Scroll x 7	
	Output		kW x n	(8.93 x 1) x 2 + (6.67 x 2) x 2	(8.93 x 1) x 1 + (6.67 x 2) x 3	(8.93 x 1) x 1 + (6.67 x 2) x 3	
	Model Name		-	(DS4GM7090FV* x 1) x 2 + (DS4GR7066FV* x 2) x 2	(DS4GM7090FV* x 1) x 1 + (DS4GR7066FV* x 2) x 3	(DS4GM7090FV* x 1) x 1 + (DS4GR7066FV* x 2) x 3	
	Oil	Type	-	PVE	PVE	PVE	
Initial charge		cc x n	(1,400 x 1) x 2 + (1,100 x 2) x 2	(1,400 x 1) x 1 + (1,100 x 2) x 3	(1,400 x 1) x 1 + (1,100 x 2) x 3		
Fan	Type		-	Propeller	Propeller	Propeller	
	Discharge direction		-	Top	Top	Top	
	Quantity		EA	8	8	8	
	Air Flow Rate		m³/min	313 x 2 + 365 x 2	313 x 1 + 342 x 1 + 365 x 2	313 x 1 + 365 x 3	
			l/s	5,209 x 2 + 6,089 x 2	5,209 x 1 + 5,698 x 1 + 6,089 x 2	5,209 x 1 + 6,089 x 3	
	External Static Pressure	Max.	mmAq	11	11	11	
Pa			110	110	110		
Fan Motor	Type		-	BLDC Motor	BLDC Motor	BLDC Motor	
	Output		W x n	(620 x 2) x 4	(620 x 2) x 4	(620 x 2) x 4	
Piping Connections	Liquid Pipe		Type	Braze connection	Braze connection	Braze connection	
			Φ, mm (inch)	25.40 (1)	25.40 (1)	25.40 (1)	
	Gas Pipe		Type	Braze connection	Braze connection	Braze connection	
			Φ, mm (inch)	53.98 (2-1/8)	53.98 (2-1/8)	53.98 (2-1/8)	
Heat Insulation		-	Both liquid and gas pipes	Both liquid and gas pipes	Both liquid and gas pipes		

2. Specification

Premium energy efficiency

Model Name				AM920AXVGGH1EU	AM940AXVGGH1EU	AM960AXVGGH1EU
	Outdoor unit module 1			AM200AXVGGH/EU	AM200AXVGGH/EU	AM180AXVGGH/EU
	Outdoor unit module 2			AM200AXVGGH/EU	AM220AXVGGH/EU	AM260AXVGGH/EU
	Outdoor unit module 3			AM260AXVGGH/EU	AM260AXVGGH/EU	AM260AXVGGH/EU
Outdoor unit module 4			AM260AXVGGH/EU	AM260AXVGGH/EU	AM260AXVGGH/EU	
Piping Connections	Piping length (ODU-IDU)	Max. [Equiv.]	m	200[220]	200[220]	200[220]
	Piping length (1st Branch-IDU)	Max.	m	90	90	90
	Total piping length (System)	Max.	m	1,000	1,000	1,000
	Level difference (ODU in highest position)	Max.	m	110	110	110
	Level difference (IDU in highest position)	Max.	m	110	110	110
	Level difference (IDU-IDU)	Max.	m	50	50	50
Wiring connections	Transmission Cable	Min.	mm ²	0.75	0.75	0.75
		Remark	-	F1, F2	F1, F2	F1, F2
	Power supply intake		-	Both indoor and outdoor unit	Both indoor and outdoor unit	Both indoor and outdoor unit
Refrigerant	Type		-	R410A	R410A	R410A
	Factory Charging		kg	10.5 x 2 + 14.0 x 2	10.5 x 2 + 14.0 x 2	10.5 x 1 + 14.0 x 3
			tCO ₂ e	102.31	102.31	109.62
Sound	Sound Pressure	Cooling	dB(A)	69	70	70
		Heating	dB(A)	71	72	72
	Sound Power			dB(A)	92	92
External Dimension	Net Weight		kg	268 x 2 + 325 x 2	268 x 1 + 301 x 1 + 325 x 2	268 x 1 + 325 x 3
	Shipping Weight		kg	285 x 2 + 342 x 2	285 x 1 + 318 x 1 + 342 x 2	285 x 1 + 342 x 3
	Net Dimensions (WxHxD)		mm	(1,295 x 1,695 x 765) x 4	(1,295 x 1,695 x 765) x 4	(1,295 x 1,695 x 765) x 4
	Shipping Dimensions (WxHxD)		mm	(1,363 x 1,887 x 829) x 4	(1,363 x 1,887 x 829) x 4	(1,363 x 1,887 x 829) x 4
Operating Temp. Range	Cooling		°C	-5 ~ 50	-5 ~ 50	-5 ~ 50
	Heating		°C	-25 ~ 24	-25 ~ 24	-25 ~ 24

NOTE

- Specification may be subject to change without prior notice.
 - Specification comply with EN14825 and Eurovent test condition
- 1) Performances are based on the following test conditions.
 - Cooling : Indoor temperature 27°CDB, 19°CWB, Outdoor temperature 35°CDB, 24°CWB
 - Heating : Indoor temperature 20°CDB, 15°CWB, Outdoor temperature 7°CDB, 6°CWB
 - Equivalent refrigerant pipe length 5m, Level differences 0m
 - Refer to EUROVENT website(www.eurovent-certification.com) for other indoor unit combination and more detail test conditions.
 - 2) Performance of Multiple Module Outdoor unit is weighted average of Single Module outdoor units.
 - 3) Allowed combination ratio of the total rated indoor unit capacity over the rated outdoor unit capacity is 50~130%.
 - 4) Sound pressure level is obtained in an anechoic room.
 - Sound pressure level is a relative value, depending on the distance and acoustic environment.
 - Sound pressure level may differ depending on operation condition.
 - dBA = A-weighted sound pressure level
 - Reference acoustic pressure 0 dB = 20uPa
 - 5) Sound power level is an absolute value that a sound source generates.
 - dBA = A-weighted sound power level
 - Reference power : 1pW
 - Measured according to ISO 3741
 - 6) Sound values of multi combination are theoretical values based on sound results of individual installed units.
 - 7) These products contain R410A (GWP=2,088) which is fluorinated greenhouse gas.
 - 8) If outdoor unit is located in a higher position than indoor unit, level difference is 110m or under.
 - (If the level difference is higher than 50m, make a decision by PDM kit installation Guide software whether the PDM kit should be installed or not.)
 - PDM kit: Pressure Drop Modulation kit
 - When the outdoor unit is below the indoor unit & the level differences are 40m or more, contact your local dealer for more information.
 - 9) In case you want to know more information regarding capacity and correction, please refer to capacity table TDB on pvi.samsung.com site.
 - 10) Recommended combination

* Ducted

Capacity	Indoor Units	Capacity	Indoor Units
8HP	AM056ANHPPKH×4	18HP	AM056ANHPPKH×4 + AM071ANHPPKH×4
10HP	AM071ANHPPKH×4	20HP	AM071ANHPPKH×8
12HP	AM056ANHPPKH×6	22HP	AM071ANHPPKH×4 + AM090ANHPPKH×4
14HP	AM056ANHPPKH×1 + AM071ANHPPKH×5	24HP	AM071ANHPPKH×1 + AM090ANLDKH×7
16HP	AM056ANHPPKH×2 + AM090ANHPPKH×4	26HP	AM090ANLDKH×6 + AM112ANLDKH×2

* Non-ducted

Capacity	Indoor Units	Capacity	Indoor Units
8HP	AM028AN4PKH + AM056AN4PKH×2 + AM090AN4PKH	18HP	AM028AN4PKH + AM056AN4PKH + AM056AN4PKH + AM056AN4PKH×2 + AM090AN4PKH×2 + AM128AN4PKH
10HP	AM056AN4PKH×2 + AM090AN4PKH×2	20HP	AM028AN4PKH + AM056AN4PKH×2 + AM090AN4PKH×2 + AM090AN4PKH×2 + AM128AN4PKH
12HP	AM028AN4PKH×2 + AM056AN4PKH×2 + AM090AN4PKH×2	22HP	AM028AN4PKH + AM056AN4PKH + AM056AN4PKH + AM090AN4PKH + AM128AN4PKH
14HP	AM028AN4PKH + AM056AN4PKH + AM056AN4PKH + AM071AN4PKH + AM090AN4PKH + AM128AN4PKH	24HP	AM028AN4PKH + AM128AN4PKH×2 + AM128AN4PKH×3
16HP	AM028AN4PKH + AM056AN4PKH + AM090AN4PKH×3 + AM128AN4PKH	26HP	AM071AN4PKH + AM128AN4PKH + AM128AN4PKH×4

2. Specification

Premium energy efficiency

Model Name				AM980AXVGGH1EU	
		Outdoor unit module 1		AM200AXVGGH/EU	
		Outdoor unit module 2		AM260AXVGGH/EU	
		Outdoor unit module 3		AM260AXVGGH/EU	
		Outdoor unit module 4		AM260AXVGGH/EU	
Power Supply			Ø, #, V, Hz	3, 4, 380-415, 50	
Mode			-	HEAT PUMP	
Performance	HP	HP		98	
	Capacity	Cooling(Rated)	kW	274.4	
		Heating(Rated)	kW	260.0	
		Heating(Max)	kW	308.7	
Maximum number of connectable indoor units			EA	64	
Total capacity of the connected Indoor Units		Min.	kW	137.2	
		Max.	kW	356.7	
Current	Current Input (Ducted)	Cooling(Rated)	A	211.46	
		Heating(Rated)	A	161.05	
	Current Input (Non-Ducted)	Cooling(Rated)	A	199.42	
		Heating(Rated)	A	177.71	
	Current	Minimum Ssc	MVA	37.6	
		MCA	A	223.0	
MFA		A	250		
Efficiency	SEER	Ducted	W/W	-	
	SCOP		W/W	-	
	ηs.c		%	-	
	ηs.h		%	-	
	SEER	Non_Ducted	W/W	-	
	SCOP		W/W	-	
	ηs.c		%	-	
	ηs.h		%	-	
Pdesignh		kW		130.1	
Casing	Material	Body	-	GI Steel Plate	
		Base	-	GI Steel Plate	
Heat Exchanger	Type		-	Fin & Tube	
	Material	Fin	-	Al	
		Tube	-	Cu	
	Fin Treatment		-	Anti-corrosion	
Compressor	Type		-	Inverter Scroll x 7	
	Output		kW x n	(8.93 x 1) x 1 + (6.67 x 2) x 3	
	Model Name		-	(DS4GM7090FV* x 1) x 1 + (DS4GR7066FV* x 2) x 3	
	Oil	Type	-	PVE	
Initial charge		cc x n		(1,400 x 1) x 1 + (1,100 x 2) x 3	
Fan	Type		-	Propeller	
	Discharge direction		-	Top	
	Quantity		EA	8	
	Air Flow Rate		m³/min		313 x 1 + 365 x 3
			l/s		5,209 x 1 + 6,089 x 3
	External Static Pressure	Max.	mmAq		11
Pa				110	
Fan Motor	Type		-	BLDC Motor	
	Output		W x n	(620 x 2) x 4	
Piping Connections	Liquid Pipe		Type	Braze connection	
			Φ, mm (inch)	25.40 (1)	
	Gas Pipe		Type	Braze connection	
			Φ, mm (inch)	53.98 (2-1/8)	
Heat Insulation		-		Both liquid and gas pipes	

2. Specification

Premium energy efficiency

Model Name				AM980AXVGGH1EU
	Outdoor unit module 1			AM200AXVGGH/EU
	Outdoor unit module 2			AM260AXVGGH/EU
	Outdoor unit module 3			AM260AXVGGH/EU
	Outdoor unit module 4			AM260AXVGGH/EU
Piping Connections	Piping length (ODU-IDU)	Max. [Equiv.]	m	200[220]
	Piping length (1st Branch-IDU)	Max.	m	90
	Total piping length (System)	Max.	m	1,000
	Level difference (ODU in highest position)	Max.	m	110
	Level difference (IDU in highest position)	Max.	m	110
	Level difference (IDU-IDU)	Max.	m	50
Wiring connections	Transmission Cable	Min.	mm ²	0.75
		Remark	-	F1, F2
	Power supply intake			Both indoor and outdoor unit
Refrigerant	Type			R410A
	Factory Charging			kg
				10.5 x 1 + 14.0 x 3
Sound	Sound Pressure	Cooling	dB(A)	70
		Heating	dB(A)	72
	Sound Power			dB(A)
External Dimension	Net Weight			kg
	Shipping Weight			kg
	Net Dimensions (WxHxD)			mm
	Shipping Dimensions (WxHxD)			mm
Operating Temp. Range	Cooling			°C
	Heating			°C

NOTE

- Specification may be subject to change without prior notice.
- Specification comply with EN14825 and Eurovent test condition
- 1) Performances are based on the following test conditions.
 - Cooling : Indoor temperature 27°CDB, 19°CWB, Outdoor temperature 35°CDB, 24°CWB
 - Heating : Indoor temperature 20°CDB, 15°CWB, Outdoor temperature 7°CDB, 6°CWB
 - Equivalent refrigerant pipe length 5m, Level differences 0m
 - Refer to EUROVENT website(www.eurovent-certification.com) for other indoor unit combination and more detail test conditions.
- 2) Performance of Multiple Module Outdoor unit is weighted average of Single Module outdoor units.
- 3) Allowed combination ratio of the total rated indoor unit capacity over the rated outdoor unit capacity is 50~130%.
- 4) Sound pressure level is obtained in an anechoic room.
 - Sound pressure level is a relative value, depending on the distance and acoustic environment.
 - Sound pressure level may differ depending on operation condition.
 - dBA = A-weighted sound pressure level
 - Reference acoustic pressure 0 dB = 20uPa
- 5) Sound power level is an absolute value that a sound source generates.
 - dBA = A-weighted sound power level
 - Reference power : 1pW
 - Measured according to ISO 3741
- 6) Sound values of multi combination are theoretical values based on sound results of individual installed units.
- 7) These products contain R410A (GWP=2,088) which is fluorinated greenhouse gas.
- 8) If outdoor unit is located in a higher position than indoor unit, level difference is 110m or under.
 - (If the level difference is higher than 50m, make a decision by PDM kit installation Guide software whether the PDM kit should be installed or not.)
 - PDM kit: Pressure Drop Modulation kit
 - When the outdoor unit is below the indoor unit & the level differences are 40m or more, contact your local dealer for more information.
- 9) In case you want to know more information regarding capacity and correction, please refer to capacity table TDB on pvi.samsung.com site.
- 10) Recommended combination

* Ducted

Capacity	Indoor Units	Capacity	Indoor Units
8HP	AM056ANHPKH×4	18HP	AM056ANHPKH×4 + AM071ANHPKH×4
10HP	AM071ANHPKH×4	20HP	AM071ANHPKH×8
12HP	AM056ANHPKH×6	22HP	AM071ANHPKH×4 + AM090ANHPKH×4
14HP	AM056ANHPKH×1 + AM071ANHPKH×5	24HP	AM071ANHPKH×1 + AM090ANLDKH×7
16HP	AM056ANHPKH×2 + AM090ANHPKH×4	26HP	AM090ANLDKH×6 + AM112ANLDKH×2

* Non-ducted

Capacity	Indoor Units	Capacity	Indoor Units
8HP	AM028AN4PKH + AM056AN4PKH×2 + AM090AN4PKH	18HP	AM028AN4PKH + AM056AN4PKH + AM056AN4PKH + AM056AN4PKH×2 + AM090AN4PKH×2 + AM128AN4PKH
10HP	AM056AN4PKH×2 + AM090AN4PKH×2	20HP	AM028AN4PKH + AM056AN4PKH×2 + AM090AN4PKH×2 + AM128AN4PKH
12HP	AM028AN4PKH×2 + AM056AN4PKH×2 + AM090AN4PKH×2	22HP	AM028AN4PKH + AM056AN4PKH + AM056AN4PKH + AM090AN4PKH×2 + AM128AN4PKH
14HP	AM028AN4PKH + AM056AN4PKH + AM056AN4PKH + AM071AN4PKH + AM090AN4PKH + AM128AN4PKH	24HP	AM071AN4PKH + AM128AN4PKH×2 + AM128AN4PKH×3
16HP	AM028AN4PKH + AM056AN4PKH + AM090AN4PKH×3 + AM128AN4PKH	26HP	AM071AN4PKH + AM128AN4PKH + AM128AN4PKH×4

2. Specification

Standard

Model Name				AM080AXVAGH/EU	AM100AXVAGH/EU	AM120AXVAGH/EU
Outdoor unit module 1				-	-	-
Outdoor unit module 2				-	-	-
Outdoor unit module 3				-	-	-
Outdoor unit module 4				-	-	-
Power Supply			Ø, #, V, Hz	3, 4, 380-415, 50	3, 4, 380-415, 50	3, 4, 380-415, 50
Mode			-	HEAT PUMP	HEAT PUMP	HEAT PUMP
Performance	HP		HP	8	10	12
	Capacity	Cooling(Rated)	kW	22.4	28.0	33.6
		Heating(Rated)	kW	22.4	28.0	33.6
		Heating(Max)	kW	25.2	31.5	37.8
Maximum number of connectable indoor units			EA	14	18	21
Total capacity of the connected Indoor Units		Min.	kW	11.2	14.0	16.8
		Max.	kW	29.1	36.4	43.7
Current	Current Input (Ducted)	Cooling(Rated)	A	12.60	18.41	19.83
		Heating(Rated)	A	9.50	12.90	14.82
	Current Input (Non-Ducted)	Cooling(Rated)	A	10.93	15.30	18.30
		Heating(Rated)	A	8.99	12.04	14.68
	Current	Minimum Ssc	MVA	3.0	3.7	4.0
		MCA	A	18.0	23.0	25.0
MFA		A	25	32	32	
Efficiency	SEER	Ducted	W/W	6.50	6.20	6.60
	SCOP		W/W	4.20	4.20	4.40
	ηs.c		%	257	245	261
	ηs.h		%	165	165	173
	SEER	Non_Ducted	W/W	7.58	6.93	7.00
	SCOP		W/W	4.06	4.23	4.28
	ηs.c		%	300.2	274.2	277
	ηs.h		%	159.4	166.2	168.2
Pdesignh			kW	13.7	16.3	18.8
Casing	Material	Body	-	GI Steel Plate	GI Steel Plate	GI Steel Plate
		Base	-	GI Steel Plate	GI Steel Plate	GI Steel Plate
Heat Exchanger	Type		-	Fin & Tube	Fin & Tube	Fin & Tube
	Material	Fin	-	Al	Al	Al
		Tube	-	Cu	Cu	Cu
Fin Treatment			-	Anti-corrosion	Anti-corrosion	Anti-corrosion
Compressor	Type			-	Inverter Scroll x 1	Inverter Scroll x 1
	Output			kW x n	4.60 x 1	6.67 x 1
	Model Name			-	DS2GR7046FV* x 1	DS4GR7066FV* x 1
	Oil	Type		-	PVE	PVE
Initial charge			cc x n	900 x 1	1,100 x 1	
Fan	Type			-	Propeller	Propeller
	Discharge direction			-	Top	Top
	Quantity			EA	1	1
	Air Flow Rate			m³/min	151	167
				l/s	2,515	2,779
	External Static Pressure	Max.		mmAq	11	11
			Pa	110	110	
Fan Motor	Type			-	BLDC Motor	BLDC Motor
	Output			W x n	630 x 1	630 x 1
Piping Connections	Liquid Pipe		Type		Braze connection	Braze connection
			Φ, mm (inch)		9.52 (3/8)	9.52 (3/8)
	Gas Pipe		Type		Braze connection	Braze connection
			Φ, mm (inch)		19.05 (3/4)	22.22 (7/8)
Heat Insulation			-	Both liquid and gas pipes	Both liquid and gas pipes	

2. Specification

Standard

Model Name				AM080AXVAGH/EU	AM100AXVAGH/EU	AM120AXVAGH/EU
Piping Connections	Outdoor unit module 1			-	-	-
	Outdoor unit module 2			-	-	-
	Outdoor unit module 3			-	-	-
	Outdoor unit module 4			-	-	-
Piping Connections	Piping length (ODU-IDU)	Max. [Equiv.]	m	200[220]	200[220]	200[220]
	Piping length (1st Branch-IDU)	Max.	m	90	90	90
	Total piping length (System)	Max.	m	1,000	1,000	1,000
	Level difference (ODU in highest position)	Max.	m	110	110	110
	Level difference (IDU in highest position)	Max.	m	110	110	110
Wiring connections	Transmission Cable	Min.	mm ²	0.75	0.75	0.75
		Remark	-	F1, F2	F1, F2	F1, F2
	Power supply intake		-	Both indoor and outdoor unit	Both indoor and outdoor unit	Both indoor and outdoor unit
Refrigerant	Type		-	R410A	R410A	R410A
	Factory Charging		kg	5.5	5.5	7.0
			tCO ₂ e		11.48	11.48
Sound	Sound Pressure	Cooling	dB(A)	53	56	61
		Heating	dB(A)	58	60	63
	Sound Power		dB(A)	75	78	81
External Dimension	Net Weight		kg	175	185	205
	Shipping Weight		kg	189	199	219
	Net Dimensions (WxHxD)		mm	930 x 1,695 x 765	930 x 1,695 x 765	930 x 1,695 x 765
	Shipping Dimensions (WxHxD)		mm	998 x 1,887 x 829	998 x 1,887 x 829	998 x 1,887 x 829
Operating Temp. Range	Cooling		°C	-5 ~ 50	-5 ~ 50	-5 ~ 50
	Heating		°C	-25 ~ 24	-25 ~ 24	-25 ~ 24

NOTE

- Specification may be subject to change without prior notice.
- Specification comply with EN14825 and Eurovent test condition
- 1) Performances are based on the following test conditions.
 - Cooling : Indoor temperature 27°CDB, 19°CWB, Outdoor temperature 35°CDB, 24°CWB
 - Heating : Indoor temperature 20°CDB, 15°CWB, Outdoor temperature 7°CDB, 6°CWB
 - Equivalent refrigerant pipe length 5m, Level differences 0m
 - Refer to EUROVENT website(www.eurovent-certification.com) for other indoor unit combination and more detail test conditions.
- 2) Performance of Multiple Module Outdoor unit is weighted average of Single Module outdoor units.
- 3) Allowed combination ratio of the total rated indoor unit capacity over the rated outdoor unit capacity is 50~130%.
- 4) Sound pressure level is obtained in an anechoic room.
 - Sound pressure level is a relative value, depending on the distance and acoustic environment.
 - Sound pressure level may differ depending on operation condition.
 - dBA = A-weighted sound pressure level
 - Reference acoustic pressure 0 dB = 20uPa
- 5) Sound power level is an absolute value that a sound source generates.
 - dBA = A-weighted sound power level
 - Reference power : 1pW
 - Measured according to ISO 3741
- 6) Sound values of multi combination are theoretical values based on sound results of individual installed units.
- 7) These products contain R410A (GWP=2,088) which is fluorinated greenhouse gas.
- 8) If outdoor unit is located in a higher position than indoor unit, level difference is 110m or under.
 - (If the level difference is higher than 50m, make a decision by PDM kit installation Guide software whether the PDM kit should be installed or not.)
 - PDM kit: Pressure Drop Modulation kit
 - When the outdoor unit is below the indoor unit & the level differences are 40m or more, contact your local dealer for more information.
- 9) In case you want to know more information regarding capacity and correction, please refer to capacity table TDB on pvi.samsung.com site.
- 10) Recommended combination

* Ducted

Capacity	Indoor Units	Capacity	Indoor Units
8HP	AM056ANHPKH×4	18HP	AM056ANHPKH×4 + AM071ANHPKH×4
10HP	AM071ANHPKH×4	20HP	AM071ANHPKH×8
12HP	AM056ANHPKH×6	22HP	AM071ANHPKH×4 + AM090ANHPKH×4
14HP	AM056ANHPKH×1 + AM071ANHPKH×5	24HP	AM071ANHPKH×1 + AM090ANLDKH×7
16HP	AM056ANHPKH×2 + AM090ANHPKH×4	26HP	AM090ANLDKH×6 + AM112ANLDKH×2

* Non-ducted

Capacity	Indoor Units	Capacity	Indoor Units
8HP	AM028AN4PKH + AM056AN4PKH×2 + AM090AN4PKH	18HP	AM028AN4PKH + AM056AN4PKH + AM056AN4PKH + AM056AN4PKH×2 + AM090AN4PKH×2 + AM128AN4PKH
10HP	AM056AN4PKH×2 + AM090AN4PKH×2	20HP	AM028AN4PKH + AM056AN4PKH + AM056AN4PKH + AM056AN4PKH×2 + AM090AN4PKH×2 + AM128AN4PKH
12HP	AM028AN4PKH×2 + AM056AN4PKH×2 + AM090AN4PKH×2	22HP	AM028AN4PKH + AM056AN4PKH + AM056AN4PKH + AM090AN4PKH×2 + AM128AN4PKH
14HP	AM028AN4PKH + AM056AN4PKH + AM056AN4PKH + AM071AN4PKH + AM090AN4PKH + AM128AN4PKH	24HP	AM071AN4PKH + AM128AN4PKH×2 + AM128AN4PKH×3
16HP	AM028AN4PKH + AM056AN4PKH + AM090AN4PKH×2 + AM128AN4PKH	26HP	AM071AN4PKH + AM128AN4PKH + AM128AN4PKH×4

2. Specification

Standard

Model Name				AM140AXVAGH/EU	AM160AXVAGH/EU	AM180AXVAGH/EU	
Outdoor unit module 1				-	-	-	
Outdoor unit module 2				-	-	-	
Outdoor unit module 3				-	-	-	
Outdoor unit module 4				-	-	-	
Power Supply			Ø, #, V, Hz	3, 4, 380-415, 50	3, 4, 380-415, 50	3, 4, 380-415, 50	
Mode			-	HEAT PUMP	HEAT PUMP	HEAT PUMP	
Performance	HP		HP	14	16	18	
	Capacity	Cooling(Rated)	kW	40.0	45.0	50.4	
		Heating(Rated)	kW	40.0	45.0	50.4	
		Heating(Max)	kW	45.0	50.4	56.7	
Maximum number of connectable indoor units			EA	26	29	32	
Total capacity of the connected Indoor Units	Min.		kW	20.0	22.5	25.2	
	Max.		kW	52.0	58.5	65.5	
Current	Current Input (Ducted)	Cooling(Rated)	A	27.72	29.47	33.87	
		Heating(Rated)	A	18.81	20.13	22.29	
	Current Input (Non-Ducted)	Cooling(Rated)	A	24.44	27.94	35.08	
		Heating(Rated)	A	18.31	19.40	23.42	
	Current	Minimum Ssc	MVA	4.6	5.2	6.3	
		MCA	A	29.0	32.0	39.2	
MFA		A	32	40	50		
Efficiency	SEER	Ducted	W/W	6.40	6.50	6.10	
	SCOP		W/W	4.20	4.30	4.20	
	ηs.c		%	253	257	241	
	ηs.h		%	165	169	165	
	SEER	Non_Ducted	W/W	6.69	6.84	6.38	
	SCOP		W/W	4.17	4.22	4.16	
	ηs.c		%	264.6	270.6	252.2	
	ηs.h		%	163.8	165.8	163.4	
Pdesignh			kW	20.3	24	26.5	
Casing	Material	Body	-	GI Steel Plate	GI Steel Plate	GI Steel Plate	
		Base	-	GI Steel Plate	GI Steel Plate	GI Steel Plate	
Heat Exchanger	Type		-	Fin & Tube	Fin & Tube	Fin & Tube	
	Material	Fin	-	Al	Al	Al	
		Tube	-	-	Cu	Cu	Cu
Fin Treatment			-	Anti-corrosion	Anti-corrosion	Anti-corrosion	
Compressor	Type			-	Inverter Scroll x 1	Inverter Scroll x 1	Inverter Scroll x 1
	Output			kW x n	6.67 x 1	8.93 x 1	8.93 x 1
	Model Name			-	DS4GR7066FV* x 1	DS4GM7090FV* x 1	DS4GM7090FV* x 1
	Oil	Type		-	PVE	PVE	PVE
		Initial charge		cc x n	1,100 x 1	1,400 x 1	1,400 x 1
Fan	Type			-	Propeller	Propeller	Propeller
	Discharge direction			-	Top	Top	Top
	Quantity			EA	1	2	2
	Air Flow Rate			m³/min	210	303	324
				l/s	3,500	5,052	5,401
	External Static Pressure	Max.		mmAq	8	11	11
			Pa	80	110	110	
Fan Motor	Type			-	BLDC Motor	BLDC Motor	BLDC Motor
	Output			W x n	630 x 1	620 x 2	620 x 2
Piping Connections	Liquid Pipe		Type		Braze connection	Braze connection	Braze connection
			Φ, mm (inch)		12.70 (1/2)	12.70 (1/2)	15.88 (5/8)
	Gas Pipe		Type		Braze connection	Braze connection	Braze connection
			Φ, mm (inch)		28.58 (1-1/8)	28.58 (1-1/8)	28.58 (1-1/8)
Heat Insulation			-	Both liquid and gas pipes	Both liquid and gas pipes	Both liquid and gas pipes	

2. Specification

Standard

Model Name				AM140AXVAGH/EU	AM160AXVAGH/EU	AM180AXVAGH/EU
Outdoor unit module 1				-	-	-
Outdoor unit module 2				-	-	-
Outdoor unit module 3				-	-	-
Outdoor unit module 4				-	-	-
Piping Connections	Piping length (ODU-IDU)	Max. [Equiv.]	m	200[220]	200[220]	200[220]
	Piping length (1st Branch-IDU)	Max.	m	90	90	90
	Total piping length (System)	Max.	m	1,000	1,000	1,000
	Level difference (ODU in highest position)	Max.	m	110	110	110
	Level difference (IDU in highest position)	Max.	m	110	110	110
Wiring connections	Transmission Cable	Min.	mm ²	0.75	0.75	0.75
		Remark	-	F1, F2	F1, F2	F1, F2
	Power supply intake		-	Both indoor and outdoor unit	Both indoor and outdoor unit	Both indoor and outdoor unit
Refrigerant	Type		-	R410A	R410A	R410A
	Factory Charging		kg	7.0	8.0	8.0
			tCO ₂ e	14.62	16.70	16.70
Sound	Sound Pressure	Cooling	dB(A)	63	60	61
		Heating	dB(A)	65	62	64
	Sound Power		dB(A)	85	81	83
External Dimension	Net Weight		kg	207	242	242
	Shipping Weight		kg	221	259	259
	Net Dimensions (WxHxD)		mm	930 x 1,695 x 765	1,295 x 1,695 x 765	1,295 x 1,695 x 765
	Shipping Dimensions (WxHxD)		mm	998 x 1,887 x 829	1,363 x 1,887 x 829	1,363 x 1,887 x 829
Operating Temp. Range	Cooling		°C	-5 ~ 50	-5 ~ 50	-5 ~ 50
	Heating		°C	-25 ~ 24	-25 ~ 24	-25 ~ 24

NOTE

- Specification may be subject to change without prior notice.
- Specification comply with EN14825 and Eurovent test condition
- 1) Performances are based on the following test conditions.
 - Cooling : Indoor temperature 27°CDB, 19°CWB, Outdoor temperature 35°CDB, 24°CWB
 - Heating : Indoor temperature 20°CDB, 15°CWB, Outdoor temperature 7°CDB, 6°CWB
 - Equivalent refrigerant pipe length 5m, Level differences 0m
 - Refer to EUROVENT website(www.eurovent-certification.com) for other indoor unit combination and more detail test conditions.
- 2) Performance of Multiple Module Outdoor unit is weighted average of Single Module outdoor units.
- 3) Allowed combination ratio of the total rated indoor unit capacity over the rated outdoor unit capacity is 50~130%.
- 4) Sound pressure level is obtained in an anechoic room.
 - Sound pressure level is a relative value, depending on the distance and acoustic environment.
 - Sound pressure level may differ depending on operation condition.
 - dBA = A-weighted sound pressure level
 - Reference acoustic pressure 0 dB = 20uPa
- 5) Sound power level is an absolute value that a sound source generates.
 - dBA = A-weighted sound power level
 - Reference power : 1pW
 - Measured according to ISO 3741
- 6) Sound values of multi combination are theoretical values based on sound results of individual installed units.
- 7) These products contain R410A (GWP=2,088) which is fluorinated greenhouse gas.
- 8) If outdoor unit is located in a higher position than indoor unit, level difference is 110m or under.
 - (If the level difference is higher than 50m, make a decision by PDM kit installation Guide software whether the PDM kit should be installed or not.)
 - PDM kit: Pressure Drop Modulation kit
 - When the outdoor unit is below the indoor unit & the level differences are 40m or more, contact your local dealer for more information.
- 9) In case you want to know more information regarding capacity and correction, please refer to capacity table TDB on pvi.samsung.com site.
- 10) Recommended combination

* Ducted

Capacity	Indoor Units	Capacity	Indoor Units
8HP	AM056ANHPKH×4	18HP	AM056ANHPKH×4 + AM071ANHPKH×4
10HP	AM071ANHPKH×4	20HP	AM071ANHPKH×8
12HP	AM056ANHPKH×6	22HP	AM071ANHPKH×4 + AM090ANHPKH×4
14HP	AM056ANHPKH×1 + AM071ANHPKH×5	24HP	AM071ANHPKH×1 + AM090ANLDKH×7
16HP	AM056ANHPKH×2 + AM090ANHPKH×4	26HP	AM090ANLDKH×6 + AM112ANLDKH×2

* Non-ducted

Capacity	Indoor Units	Capacity	Indoor Units
8HP	AM028ANPKH + AM056ANPKH×2 + AM090ANPKH	18HP	AM028ANPKH + AM056ANPKH + AM056ANPKH + AM056ANPKH×2 + AM090ANPKH×2 + AM128ANPKH
10HP	AM056ANPKH×2 + AM090ANPKH×2	20HP	AM028ANPKH + AM056ANPKH + AM056ANPKH + AM056ANPKH×2 + AM090ANPKH×2 + AM128ANPKH
12HP	AM028ANPKH×2 + AM056ANPKH×2 + AM090ANPKH×2	22HP	AM028ANPKH + AM056ANPKH + AM056ANPKH + AM056ANPKH×2 + AM090ANPKH×2 + AM128ANPKH
14HP	AM028ANPKH + AM056ANPKH + AM056ANPKH + AM071ANPKH + AM090ANPKH + AM128ANPKH	24HP	AM071ANPKH + AM128ANPKH×2 + AM128ANPKH×3
16HP	AM028ANPKH + AM056ANPKH + AM090ANPKH×3 + AM128ANPKH	26HP	AM071ANPKH + AM128ANPKH + AM128ANPKH×4

2. Specification

Standard

Model Name				AM200AXVAGH/EU	AM220AXVAGH/EU	AM240AXVAGH/EU	
Outdoor unit module 1				-	-	-	
Outdoor unit module 2				-	-	-	
Outdoor unit module 3				-	-	-	
Outdoor unit module 4				-	-	-	
Power Supply			Ø, #, V, Hz	3, 4, 380-415, 50	3, 4, 380-415, 50	3, 4, 380-415, 50	
Mode			-	HEAT PUMP	HEAT PUMP	HEAT PUMP	
Performance	HP		HP	20	22	24	
	Capacity	Cooling(Rated)	kW	56.0	61.6	67.2	
		Heating(Rated)	kW	56.0	61.6	67.2	
		Heating(Max)	kW	63.0	69.3	75.6	
Maximum number of connectable indoor units			EA	36	40	43	
Total capacity of the connected Indoor Units		Min.	kW	28.0	30.8	33.6	
		Max.	kW	72.8	80.1	87.4	
Current	Current Input (Ducted)	Cooling(Rated)	A	39.87	45.43	50.05	
		Heating(Rated)	A	26.49	28.11	45.58	
	Current Input (Non-Ducted)	Cooling(Rated)	A	37.29	39.99	48.85	
		Heating(Rated)	A	25.95	27.36	45.58	
	Current	Minimum Ssc	MVA	7.0	7.4	9.3	
		MCA	A	43.0	46.0	55.0	
MFA		A	63	63	63		
Efficiency	SEER	Ducted	W/W	6.20	5.90	5.60	
	SCOP		W/W	4.10	4.10	3.70	
	ηs.c		%	245	233	221	
	ηs.h		%	161	161	145	
	SEER	Non_Ducted	W/W	6.61	6.83	5.76	
	SCOP		W/W	4.14	4.26	3.70	
	ηs.c		%	261.4	270.2	227.4	
	ηs.h		%	162.6	167.4	145	
Pdesignh			kW	29.1	30.1	31	
Casing	Material	Body	-	GI Steel Plate	GI Steel Plate	GI Steel Plate	
		Base	-	GI Steel Plate	GI Steel Plate	GI Steel Plate	
Heat Exchanger	Type		-	Fin & Tube	Fin & Tube	Fin & Tube	
	Material	Fin	-	Al	Al	Al	
		Tube	-	Cu	Cu	Cu	
Fin Treatment			-	Anti-corrosion	Anti-corrosion	Anti-corrosion	
Compressor	Type			-	Inverter Scroll x 1	Inverter Scroll x 2	Inverter Scroll x 2
	Output		kW x n		8.93 x 1	6.67 x 2	6.67 x 2
	Model Name			-	DS4GM7090FV* x 1	DS4GR7066FV* x 2	DS4GR7066FV* x 2
	Oil	Type		-	PVE	PVE	PVE
Initial charge		cc x n		1,400 x 1	1,100 x 2	1,100 x 2	
Fan	Type			-	Propeller	Propeller	Propeller
	Discharge direction			-	Top	Top	Top
	Quantity		EA		2	2	2
	Air Flow Rate		m³/min		313	342	365
			l/s		5,209	5,698	6,089
External Static Pressure	Max.	mmAq		11	11	8	
		Pa		110	110	80	
Fan Motor	Type			-	BLDC Motor	BLDC Motor	BLDC Motor
	Output		W x n		620 x 2	620 x 2	620 x 2
Piping Connections	Liquid Pipe		Type		Braze connection	Braze connection	Braze connection
			Φ, mm (inch)		15.88 (5/8)	15.88 (5/8)	15.88 (5/8)
	Gas Pipe		Type		Braze connection	Braze connection	Braze connection
			Φ, mm (inch)		28.58 (1-1/8)	28.58 (1-1/8)	34.92 (1-3/8)
Heat Insulation			-	Both liquid and gas pipes	Both liquid and gas pipes	Both liquid and gas pipes	

2. Specification

Standard

Model Name				AM200AXVAGH/EU	AM220AXVAGH/EU	AM240AXVAGH/EU
Outdoor unit module 1				-	-	-
Outdoor unit module 2				-	-	-
Outdoor unit module 3				-	-	-
Outdoor unit module 4				-	-	-
Piping Connections	Piping length (ODU-IDU)	Max. [Equiv.]	m	200[220]	200[220]	200[220]
	Piping length (1st Branch-IDU)	Max.	m	90	90	90
	Total piping length (System)	Max.	m	1,000	1,000	1,000
	Level difference (ODU in highest position)	Max.	m	110	110	110
	Level difference (IDU in highest position)	Max.	m	110	110	110
Wiring connections	Transmission Cable	Min.	mm ²	0.75	0.75	0.75
		Remark	-	F1, F2	F1, F2	F1, F2
	Power supply intake		-	Both indoor and outdoor unit	Both indoor and outdoor unit	Both indoor and outdoor unit
Refrigerant	Type		-	R410A	R410A	R410A
	Factory Charging		kg	10.5	10.5	14.0
			tCO ₂ e		21.92	21.92
Sound	Sound Pressure	Cooling	dB(A)	61	64	65
		Heating	dB(A)	63	65	67
	Sound Power		dB(A)	84	86	87
External Dimension	Net Weight		kg	268	301	325
	Shipping Weight		kg	285	318	342
	Net Dimensions (WxHxD)		mm	1,295 x 1,695 x 765	1,295 x 1,695 x 765	1,295 x 1,695 x 765
	Shipping Dimensions (WxHxD)		mm	1,363 x 1,887 x 829	1,363 x 1,887 x 829	1,363 x 1,887 x 829
Operating Temp. Range	Cooling		°C	-5 ~ 50	-5 ~ 50	-5 ~ 50
	Heating		°C	-25 ~ 24	-25 ~ 24	-25 ~ 24

NOTE

- Specification may be subject to change without prior notice.
 - Specification comply with EN14825 and Eurovent test condition
- 1) Performances are based on the following test conditions.
 - Cooling : Indoor temperature 27°CDB, 19°CWB, Outdoor temperature 35°CDB, 24°CWB
 - Heating : Indoor temperature 20°CDB, 15°CWB, Outdoor temperature 7°CDB, 6°CWB
 - Equivalent refrigerant pipe length 5m, Level differences 0m
 - Refer to EUROVENT website(www.eurovent-certification.com) for other indoor unit combination and more detail test conditions.
 - 2) Performance of Multiple Module Outdoor unit is weighted average of Single Module outdoor units.
 - 3) Allowed combination ratio of the total rated indoor unit capacity over the rated outdoor unit capacity is 50~130%.
 - 4) Sound pressure level is obtained in an anechoic room.
 - Sound pressure level is a relative value, depending on the distance and acoustic environment.
 - Sound pressure level may differ depending on operation condition.
 - dBA = A-weighted sound pressure level
 - Reference acoustic pressure 0 dB = 20uPa
 - 5) Sound power level is an absolute value that a sound source generates.
 - dBA = A-weighted sound power level
 - Reference power : 1pW
 - Measured according to ISO 3741
 - 6) Sound values of multi combination are theoretical values based on sound results of individual installed units.
 - 7) These products contain R410A (GWP=2,088) which is fluorinated greenhouse gas.
 - 8) If outdoor unit is located in a higher position than indoor unit, level difference is 110m or under.
 - (If the level difference is higher than 50m, make a decision by PDM kit installation Guide software whether the PDM kit should be installed or not.)
 - PDM kit: Pressure Drop Modulation kit
 - When the outdoor unit is below the indoor unit & the level differences are 40m or more, contact your local dealer for more information.
 - 9) In case you want to know more information regarding capacity and correction, please refer to capacity table TDB on pvi.samsung.com site.
 - 10) Recommended combination

* Ducted

Capacity	Indoor Units	Capacity	Indoor Units
8HP	AM056ANHPKH×4	18HP	AM056ANHPKH×4 + AM071ANHPKH×4
10HP	AM071ANHPKH×4	20HP	AM071ANHPKH×8
12HP	AM056ANHPKH×6	22HP	AM071ANHPKH×4 + AM090ANHPKH×4
14HP	AM056ANHPKH×1 + AM071ANHPKH×5	24HP	AM071ANHPKH×1 + AM090ANLDKH×7
16HP	AM056ANHPKH×2 + AM090ANHPKH×4	26HP	AM090ANLDKH×6 + AM112ANLDKH×2

* Non-ducted

Capacity	Indoor Units	Capacity	Indoor Units
8HP	AM028ANPKH + AM056ANPKH×2 + AM090ANPKH	18HP	AM028ANPKH + AM056ANPKH + AM056ANPKH + AM056ANPKH×2 + AM090ANPKH×2 + AM128ANPKH
10HP	AM056ANPKH×2 + AM090ANPKH×2	20HP	AM028ANPKH + AM056ANPKH + AM056ANPKH + AM056ANPKH×2 + AM090ANPKH×2 + AM128ANPKH
12HP	AM028ANPKH×2 + AM056ANPKH×2 + AM090ANPKH×2	22HP	AM028ANPKH + AM056ANPKH + AM056ANPKH + AM056ANPKH×2 + AM090ANPKH×2 + AM128ANPKH
14HP	AM028ANPKH + AM056ANPKH + AM056ANPKH + AM071ANPKH + AM090ANPKH + AM128ANPKH	24HP	AM071ANPKH + AM128ANPKH×2 + AM128ANPKH×3
16HP	AM028ANPKH + AM056ANPKH + AM090ANPKH×3 + AM128ANPKH	26HP	AM071ANPKH + AM128ANPKH + AM128ANPKH×4

2. Specification

Standard

Model Name				AM260AXVAGH/EU	AM280AXVAGH1EU	AM300AXVAGH1EU
Outdoor unit module 1				-	AM080AXVAGH/EU	AM120AXVAGH/EU
Outdoor unit module 2				-	AM200AXVAGH/EU	AM180AXVAGH/EU
Outdoor unit module 3				-	-	-
Outdoor unit module 4				-	-	-
Power Supply			Ø, #, V, Hz	3, 4, 380-415, 50	3, 4, 380-415, 50	3, 4, 380-415, 50
Mode			-	HEAT PUMP	HEAT PUMP	HEAT PUMP
Performance	HP		HP	26	28	30
	Capacity	Cooling(Rated)	kW	72.8	78.4	84.0
		Heating(Rated)	kW	68.0	78.4	84.0
		Heating(Max)	kW	81.9	88.2	94.5
Maximum number of connectable indoor units			EA	47	51	54
Total capacity of the connected Indoor Units		Min.	kW	36.4	39.2	42.0
		Max.	kW	94.6	101.9	109.2
Current	Current Input (Ducted)	Cooling(Rated)	A	58.83	52.47	53.70
		Heating(Rated)	A	46.54	35.99	37.11
	Current Input (Non-Ducted)	Cooling(Rated)	A	58.83	48.22	53.38
		Heating(Rated)	A	46.54	34.94	38.10
	Current	Minimum Ssc	MVA	10.2	10.0	10.3
		MCA	A	60.0	61.0	64.2
MFA		A	75	75	75	
Efficiency	SEER	Ducted	W/W	5.10	-	-
	SCOP		W/W	3.70	-	-
	ηs.c		%	201	-	-
	ηs.h		%	145	-	-
	SEER	Non_Ducted	W/W	5.29	-	-
	SCOP		W/W	3.70	-	-
	ηs.c		%	208.6	-	-
	ηs.h		%	145	-	-
Pdesignh		kW	32	42.8	45.3	
Casing	Material	Body	-	GI Steel Plate	GI Steel Plate	GI Steel Plate
		Base	-	GI Steel Plate	GI Steel Plate	GI Steel Plate
Heat Exchanger	Type		-	Fin & Tube	Fin & Tube	Fin & Tube
	Material	Fin	-	Al	Al	Al
		Tube	-	Cu	Cu	Cu
Fin Treatment			-	Anti-corrosion	Anti-corrosion	Anti-corrosion
Compressor	Type		-	Inverter Scroll x 2	Inverter Scroll x 2	Inverter Scroll x 2
	Output		kW x n	6.67 x 2	(4.60 x 1) x 1 + (8.93 x 1) x 1	(6.67 x 1) x 1 + (8.93 x 1) x 1
	Model Name		-	DS4GR7066FV* x 2	(DS2GR7046FV* x 1) x 1 + (DS4GM7090FV* x 1) x 1	(DS4GR7066FV* x 1) x 1 + (DS4GM7090FV* x 1) x 1
	Oil	Type	-	PVE	PVE	PVE
Initial charge		cc x n	1,100 x 2	(900 x 1) x 1 + (1,400 x 1) x 1	(1,100 x 1) x 1 + (1,400 x 1) x 1	
Fan	Type		-	Propeller	Propeller	Propeller
	Discharge direction			-	Top	Top
	Quantity		EA	2	3	3
	Air Flow Rate		m ³ /min	365	151 x 1 + 313 x 1	196 x 1 + 324 x 1
			l/s	6,089	2,515 x 1 + 5,209 x 1	3,260 x 1 + 5,401 x 1
	External Static Pressure	Max.	mmAq	8	11	11
Fan Motor	Type		-	BLDC Motor	BLDC Motor	BLDC Motor
	Output		W x n	620 x 2	(630 x 1) x 1 + (620 x 2)	(630 x 1) x 1 + (620 x 2)
Piping Connections	Liquid Pipe		Type	Braze connection	Braze connection	Braze connection
			Φ, mm (inch)	19.05 (3/4)	19.05 (3/4)	19.05 (3/4)
	Gas Pipe		Type	Braze connection	Braze connection	Braze connection
			Φ, mm (inch)	34.92 (1-3/8)	34.92 (1-3/8)	34.92 (1-3/8)
Heat Insulation			-	Both liquid and gas pipes	Both liquid and gas pipes	Both liquid and gas pipes

2. Specification

Standard

Model Name				AM260AXVAGH/EU	AM280AXVAGH1EU	AM300AXVAGH1EU
Outdoor unit module 1				-	AM080AXVAGH/EU	AM120AXVAGH/EU
Outdoor unit module 2				-	AM200AXVAGH/EU	AM180AXVAGH/EU
Outdoor unit module 3				-	-	-
Outdoor unit module 4				-	-	-
Piping Connections	Piping length (ODU-IDU)	Max. [Equiv.]	m	200[220]	200[220]	200[220]
	Piping length (1st Branch-IDU)	Max.	m	90	90	90
	Total piping length (System)	Max.	m	1,000	1,000	1,000
	Level difference (ODU in highest position)	Max.	m	110	110	110
	Level difference (IDU in highest position)	Max.	m	110	110	110
	Level difference (IDU-IDU)	Max.	m	50	50	50
Wiring connections	Transmission Cable	Min.	mm ²	0.75	0.75	0.75
		Remark	-	F1, F2	F1, F2	F1, F2
	Power supply intake		-	Both indoor and outdoor unit	Both indoor and outdoor unit	Both indoor and outdoor unit
Refrigerant	Type		-	R410A	R410A	R410A
	Factory Charging		kg	14.0	5.5 x 1 + 10.5 x 1	7.0 x 1 + 8.0 x 1
			tCO ₂ e	29.23	33.41	31.32
Sound	Sound Pressure	Cooling	dB(A)	65	62	64
		Heating	dB(A)	67	64	67
	Sound Power		dB(A)	87	85	85
External Dimension	Net Weight		kg	325	175 x 1 + 268 x 1	205 x 1 + 242 x 1
	Shipping Weight		kg	342	189 x 1 + 285 x 1	219 x 1 + 259 x 1
	Net Dimensions (WxHxD)		mm	1,295 x 1,695 x 765	(930 x 1,695 x 765) x 1 + (1,295 x 1,695 x 765) x 1	(930 x 1,695 x 765) x 1 + (1,295 x 1,695 x 765) x 1
	Shipping Dimensions (WxHxD)		mm	1,363 x 1,887 x 829	(998 x 1,887 x 829) x 1 + (1,363 x 1,887 x 829) x 1	(998 x 1,887 x 829) x 1 + (1,363 x 1,887 x 829) x 1
Operating Temp. Range	Cooling		°C	-5 ~ 50	-5 ~ 50	-5 ~ 50
	Heating		°C	-25 ~ 24	-25 ~ 24	-25 ~ 24

NOTE

- Specification may be subject to change without prior notice.
- Specification comply with EN14825 and Eurovent test condition
- 1) Performances are based on the following test conditions.
 - Cooling : Indoor temperature 27°CDB, 19°CWB, Outdoor temperature 35°CDB, 24°CWB
 - Heating : Indoor temperature 20°CDB, 15°CWB, Outdoor temperature 7°CDB, 6°CWB
 - Equivalent refrigerant pipe length 5m, Level differences 0m
 - Refer to EUROVENT website(www.eurovent-certification.com) for other indoor unit combination and more detail test conditions.
- 2) Performance of Multiple Module Outdoor unit is weighted average of Single Module outdoor units.
- 3) Allowed combination ratio of the total rated indoor unit capacity over the rated outdoor unit capacity is 50~130%.
- 4) Sound pressure level is obtained in an anechoic room.
 - Sound pressure level is a relative value, depending on the distance and acoustic environment.
 - Sound pressure level may differ depending on operation condition.
 - dBA = A-weighted sound pressure level
 - Reference acoustic pressure 0 dB = 20uPa
- 5) Sound power level is an absolute value that a sound source generates.
 - dBA = A-weighted sound power level
 - Reference power : 1pW
 - Measured according to ISO 3741
- 6) Sound values of multi combination are theoretical values based on sound results of individual installed units.
- 7) These products contain R410A (GWP=2,088) which is fluorinated greenhouse gas.
- 8) If outdoor unit is located in a higher position than indoor unit, level difference is 110m or under.
 - (If the level difference is higher than 50m, make a decision by PDM kit installation Guide software whether the PDM kit should be installed or not.)
 - PDM kit: Pressure Drop Modulation kit
 - When the outdoor unit is below the indoor unit & the level differences are 40m or more, contact your local dealer for more information.
- 9) In case you want to know more information regarding capacity and correction, please refer to capacity table TDB on pvi.samsung.com site.
- 10) Recommended combination

* Ducted

Capacity	Indoor Units	Capacity	Indoor Units
8HP	AM056ANHPKH×4	18HP	AM056ANHPKH×4 + AM071ANHPKH×4
10HP	AM071ANHPKH×4	20HP	AM071ANHPKH×8
12HP	AM056ANHPKH×6	22HP	AM071ANHPKH×4 + AM090ANHPKH×4
14HP	AM056ANHPKH×1 + AM071ANHPKH×5	24HP	AM071ANHPKH×1 + AM090ANLDKH×7
16HP	AM056ANHPKH×2 + AM090ANHPKH×4	26HP	AM090ANLDKH×6 + AM112ANLDKH×2

* Non-ducted

Capacity	Indoor Units	Capacity	Indoor Units
8HP	AM028AN4PKH + AM056AN4PKH×2 + AM090AN4PKH	18HP	AM028AN4PKH + AM056AN4PKH + AM056AN4PKH + AM056AN4PKH×2 + AM090AN4PKH×2 + AM128AN4PKH
10HP	AM056AN4PKH×2 + AM090AN4PKH×2	20HP	AM028AN4PKH + AM056AN4PKH×2 + AM090AN4PKH×2 + AM128AN4PKH
12HP	AM028AN4PKH×2 + AM056AN4PKH×2 + AM090AN4PKH×2	22HP	AM028AN4PKH + AM056AN4PKH + AM056AN4PKH + AM090AN4PKH + AM128AN4PKH
14HP	AM028AN4PKH + AM056AN4PKH + AM056AN4PKH + AM071AN4PKH + AM090AN4PKH + AM128AN4PKH	24HP	AM071AN4PKH + AM128AN4PKH×2 + AM128AN4PKH×3
16HP	AM028AN4PKH + AM056AN4PKH + AM090AN4PKH×3 + AM128AN4PKH	26HP	AM071AN4PKH + AM128AN4PKH + AM128AN4PKH×4

2. Specification

Standard

Model Name				AM320AXVAGH1EU	AM340AXVAGH1EU	AM360AXVAGH1EU		
				Outdoor unit module 1		AM080AXVAGH/EU	AM100AXVAGH/EU	AM120AXVAGH/EU
				Outdoor unit module 2		AM240AXVAGH/EU	AM240AXVAGH/EU	AM240AXVAGH/EU
				Outdoor unit module 3		-	-	-
				Outdoor unit module 4		-	-	-
Power Supply			Ø, #, V, Hz	3, 4, 380-415, 50	3, 4, 380-415, 50	3, 4, 380-415, 50		
Mode			-	HEAT PUMP	HEAT PUMP	HEAT PUMP		
Performance	HP		HP	32	34	36		
	Capacity	Cooling(Rated)	kW	89.6	95.2	100.8		
		Heating(Rated)	kW	89.6	95.2	100.8		
		Heating(Max)	kW	100.8	107.1	113.4		
Maximum number of connectable indoor units			EA	58	61	64		
Total capacity of the connected Indoor Units		Min.	kW	44.8	47.6	50.4		
		Max.	kW	116.5	123.8	131.0		
Current	Current Input (Ducted)	Cooling(Rated)	A	62.65	68.46	69.88		
		Heating(Rated)	A	55.08	58.48	60.40		
	Current Input (Non-Ducted)	Cooling(Rated)	A	59.78	64.15	67.15		
		Heating(Rated)	A	54.57	57.62	60.26		
	Current	Minimum Ssc	MVA	12.3	13.0	13.3		
		MCA	A	73.0	78.0	80.0		
MFA		A	80	90	90			
Efficiency	SEER	Ducted	W/W	-	-	-		
	SCOP		W/W	-	-	-		
	ηs.c		%	-	-	-		
	ηs.h		%	-	-	-		
	SEER	Non_Ducted	W/W	-	-	-		
	SCOP		W/W	-	-	-		
	ηs.c		%	-	-	-		
	ηs.h		%	-	-	-		
Pdesignh		kW	44.7	47.3	49.8			
Casing	Material	Body	-	GI Steel Plate	GI Steel Plate	GI Steel Plate		
		Base	-	GI Steel Plate	GI Steel Plate	GI Steel Plate		
Heat Exchanger	Type		-	Fin & Tube	Fin & Tube	Fin & Tube		
	Material	Fin	-	Al	Al	Al		
		Tube	-	Cu	Cu	Cu		
Fin Treatment			-	Anti-corrosion	Anti-corrosion	Anti-corrosion		
Compressor	Type			-	Inverter Scroll x 3	Inverter Scroll x 3	Inverter Scroll x 3	
	Output		kW x n	(4.60 x 1) x 1 + (6.67 x 2) x 1	(6.67 x 1) x 1 + (6.67 x 2) x 1	(6.67 x 1) x 1 + (6.67 x 2) x 1		
	Model Name		-	(DS2GR7046FV* x 1) x 1 + (DS4GR7066FV* x 2) x 1	(DS4GR7066FV* x 1) x 1 + (DS4GR7066FV* x 2) x 1	(DS4GR7066FV* x 1) x 1 + (DS4GR7066FV* x 2) x 1		
	Oil	Type	-	PVE	PVE	PVE		
Initial charge		cc x n	(900 x 1) x 1 + (1,100 x 2) x 1	(1,100 x 1) x 1 + (1,100 x 2) x 1	(1,100 x 1) x 1 + (1,100 x 2) x 1			
Fan	Type			-	Propeller	Propeller	Propeller	
	Discharge direction			-	Top	Top	Top	
	Quantity		EA	3	3	3		
	Air Flow Rate		m³/min	151 x 1 + 365 x 1	167 x 1 + 365 x 1	196 x 1 + 365 x 1		
			l/s	2,515 x 1 + 6,089 x 1	2,779 x 1 + 6,089 x 1	3,260 x 1 + 6,089 x 1		
	External Static Pressure	Max.	mmAq	11	11	11		
Pa			110	110	110			
Fan Motor	Type			-	BLDC Motor	BLDC Motor	BLDC Motor	
	Output		W x n	(630 x 1) x 1 + (620 x 2)	(630 x 1) x 1 + (620 x 2)	(630 x 1) x 1 + (620 x 2)		
Piping Connections	Liquid Pipe		Type	Braze connection	Braze connection	Braze connection		
			Φ, mm (inch)	19.05 (3/4)	19.05 (3/4)	19.05 (3/4)		
	Gas Pipe		Type	Braze connection	Braze connection	Braze connection		
			Φ, mm (inch)	34.92 (1-3/8)	34.92 (1-3/8)	41.28 (1-5/8)		
Heat Insulation			-	Both liquid and gas pipes	Both liquid and gas pipes	Both liquid and gas pipes		

2. Specification

Standard

Model Name				AM320AXVAGH1EU	AM340AXVAGH1EU	AM360AXVAGH1EU
	Outdoor unit module 1			AM080AXVAGH/EU	AM100AXVAGH/EU	AM120AXVAGH/EU
	Outdoor unit module 2			AM240AXVAGH/EU	AM240AXVAGH/EU	AM240AXVAGH/EU
	Outdoor unit module 3			-	-	-
	Outdoor unit module 4			-	-	-
Piping Connections	Piping length (ODU-IDU)	Max. [Equiv.]	m	200[220]	200[220]	200[220]
	Piping length (1st Branch-IDU)	Max.	m	90	90	90
	Total piping length (System)	Max.	m	1,000	1,000	1,000
	Level difference (ODU in highest position)	Max.	m	110	110	110
	Level difference (IDU in highest position)	Max.	m	110	110	110
	Level difference (IDU-IDU)	Max.	m	50	50	50
Wiring connections	Transmission Cable	Min.	mm ²	0.75	0.75	0.75
		Remark	-	F1, F2	F1, F2	F1, F2
	Power supply intake		-	Both indoor and outdoor unit	Both indoor and outdoor unit	Both indoor and outdoor unit
Refrigerant	Type		-	R410A	R410A	R410A
	Factory Charging		kg	5.5 x 1 + 14.0 x 1	5.5 x 1 + 14.0 x 1	7.0 x 1 + 14.0 x 1
			tCO ₂ e	40.72	40.72	43.85
Sound	Sound Pressure	Cooling	dB(A)	65	66	66
		Heating	dB(A)	68	68	68
	Sound Power		dB(A)	87	88	88
External Dimension	Net Weight		kg	175 x 1 + 325 x 1	185 x 1 + 325 x 1	205 x 1 + 325 x 1
	Shipping Weight		kg	189 x 1 + 342 x 1	199 x 1 + 342 x 1	219 x 1 + 342 x 1
	Net Dimensions (WxHxD)		mm	(930 x 1,695 x 765) x 1 + (1,295 x 1,695 x 765) x 1	(930 x 1,695 x 765) x 1 + (1,295 x 1,695 x 765) x 1	(930 x 1,695 x 765) x 1 + (1,295 x 1,695 x 765) x 1
	Shipping Dimensions (WxHxD)		mm	(998 x 1,887 x 829) x 1 + (1,363 x 1,887 x 829) x 1	(998 x 1,887 x 829) x 1 + (1,363 x 1,887 x 829) x 1	(998 x 1,887 x 829) x 1 + (1,363 x 1,887 x 829) x 1
Operating Temp. Range	Cooling		°C	-5 ~ 50	-5 ~ 50	-5 ~ 50
	Heating		°C	-25 ~ 24	-25 ~ 24	-25 ~ 24

NOTE

- Specification may be subject to change without prior notice.
 - Specification comply with EN14825 and Eurovent test condition
- 1) Performances are based on the following test conditions.
 - Cooling : Indoor temperature 27°CDB, 19°CWB, Outdoor temperature 35°CDB, 24°CWB
 - Heating : Indoor temperature 20°CDB, 15°CWB, Outdoor temperature 7°CDB, 6°CWB
 - Equivalent refrigerant pipe length 5m, Level differences 0m
 - Refer to EUROVENT website(www.eurovent-certification.com) for other indoor unit combination and more detail test conditions.
 - 2) Performance of Multiple Module Outdoor unit is weighted average of Single Module outdoor units.
 - 3) Allowed combination ratio of the total rated indoor unit capacity over the rated outdoor unit capacity is 50~130%.
 - 4) Sound pressure level is obtained in an anechoic room.
 - Sound pressure level is a relative value, depending on the distance and acoustic environment.
 - Sound pressure level may differ depending on operation condition.
 - dBA = A-weighted sound pressure level
 - Reference acoustic pressure 0 dB = 20uPa
 - 5) Sound power level is an absolute value that a sound source generates.
 - dBA = A-weighted sound power level
 - Reference power : 1pW
 - Measured according to ISO 3741
 - 6) Sound values of multi combination are theoretical values based on sound results of individual installed units.
 - 7) These products contain R410A (GWP=2,088) which is fluorinated greenhouse gas.
 - 8) If outdoor unit is located in a higher position than indoor unit, level difference is 110m or under.
 - (If the level difference is higher than 50m, make a decision by PDM kit installation Guide software whether the PDM kit should be installed or not.)
 - PDM kit: Pressure Drop Modulation kit
 - When the outdoor unit is below the indoor unit & the level differences are 40m or more, contact your local dealer for more information.
 - 9) In case you want to know more information regarding capacity and correction, please refer to capacity table TDB on pvi.samsung.com site.
 - 10) Recommended combination

* Ducted

Capacity	Indoor Units	Capacity	Indoor Units
8HP	AM056ANHPKH×4	18HP	AM056ANHPKH×4 + AM071ANHPKH×4
10HP	AM071ANHPKH×4	20HP	AM071ANHPKH×8
12HP	AM056ANHPKH×6	22HP	AM071ANHPKH×4 + AM090ANHPKH×4
14HP	AM056ANHPKH×1 + AM071ANHPKH×5	24HP	AM071ANHPKH×1 + AM090ANLDKH×7
16HP	AM056ANHPKH×2 + AM090ANHPKH×4	26HP	AM090ANLDKH×6 + AM112ANLDKH×2

* Non-ducted

Capacity	Indoor Units	Capacity	Indoor Units
8HP	AM028ANPKH + AM056ANPKH×2 + AM090ANPKH	18HP	AM028ANPKH + AM056ANPKH + AM056ANPKH + AM056ANPKH×2 + AM090ANPKH×2 + AM128ANPKH
10HP	AM056ANPKH×2 + AM090ANPKH×2	20HP	AM028ANPKH + AM056ANPKH×2 + AM090ANPKH×2 + AM128ANPKH
12HP	AM028ANPKH×2 + AM056ANPKH×2 + AM090ANPKH×2	22HP	AM028ANPKH + AM056ANPKH + AM056ANPKH + AM090ANPKH + AM128ANPKH
14HP	AM028ANPKH + AM056ANPKH + AM056ANPKH + AM071ANPKH + AM090ANPKH + AM128ANPKH	24HP	AM071ANPKH + AM128ANPKH×2 + AM128ANPKH×3
16HP	AM028ANPKH + AM056ANPKH + AM090ANPKH×3 + AM128ANPKH	26HP	AM071ANPKH + AM128ANPKH + AM128ANPKH×4

2. Specification

Standard

Model Name				AM380AXVAGH1EU	AM400AXVAGH1EU	AM420AXVAGH1EU	
				Outdoor unit module 1	AM140AXVAGH/EU	AM160AXVAGH/EU	AM180AXVAGH/EU
				Outdoor unit module 2	AM240AXVAGH/EU	AM240AXVAGH/EU	AM240AXVAGH/EU
				Outdoor unit module 3	-	-	-
				Outdoor unit module 4	-	-	-
Power Supply			Ø, #, V, Hz	3, 4, 380-415, 50	3, 4, 380-415, 50	3, 4, 380-415, 50	
Mode			-	HEAT PUMP	HEAT PUMP	HEAT PUMP	
Performance	HP		HP	38	40	42	
	Capacity	Cooling(Rated)	kW	107.2	112.2	117.6	
		Heating(Rated)	kW	107.2	112.2	117.6	
		Heating(Max)	kW	120.6	126.0	132.3	
Maximum number of connectable indoor units			EA	64	64	64	
Total capacity of the connected Indoor Units		Min.	kW	53.6	56.1	58.8	
		Max.	kW	139.4	145.9	152.9	
Current	Current Input (Ducted)	Cooling(Rated)	A	77.77	79.52	83.92	
		Heating(Rated)	A	64.39	65.71	67.87	
	Current Input (Non-Ducted)	Cooling(Rated)	A	73.29	76.79	83.93	
		Heating(Rated)	A	63.89	64.98	69.00	
	Current	Minimum Ssc	MVA	13.9	14.5	15.6	
		MCA	A	84.0	87.0	94.2	
MFA		A	100	100	125		
Efficiency	SEER	Ducted	W/W	-	-	-	
	SCOP		W/W	-	-	-	
	ηs.c		%	-	-	-	
	ηs.h		%	-	-	-	
	SEER	Non_Ducted	W/W	-	-	-	
	SCOP		W/W	-	-	-	
	ηs.c		%	-	-	-	
	ηs.h		%	-	-	-	
Pdesignh		kW	51.3	55	57.5		
Casing	Material	Body	-	GI Steel Plate	GI Steel Plate	GI Steel Plate	
		Base	-	GI Steel Plate	GI Steel Plate	GI Steel Plate	
Heat Exchanger	Type		-	Fin & Tube	Fin & Tube	Fin & Tube	
	Material	Fin	-	Al	Al	Al	
		Tube	-	Cu	Cu	Cu	
Fin Treatment			-	Anti-corrosion	Anti-corrosion	Anti-corrosion	
Compressor	Type		-	Inverter Scroll x 3	Inverter Scroll x 3	Inverter Scroll x 3	
	Output		kW x n	(6.67 x 1) x 1 + (6.67 x 2) x 1	(8.93 x 1) x 1 + (6.67 x 2) x 1	(8.93 x 1) x 1 + (6.67 x 2) x 1	
	Model Name		-	(DS4GR7066FV* x 1) x 1 + (DS4GR7066FV* x 2) x 1	(DS4GM7090FV* x 1) x 1 + (DS4GR7066FV* x 2) x 1	(DS4GM7090FV* x 1) x 1 + (DS4GR7066FV* x 2) x 1	
	Oil	Type	-	PVE	PVE	PVE	
Initial charge		cc x n	(1,100 x 1) x 1 + (1,100 x 2) x 1	(1,400 x 1) x 1 + (1,100 x 2) x 1	(1,400 x 1) x 1 + (1,100 x 2) x 1		
Fan	Type		-	Propeller	Propeller	Propeller	
	Discharge direction		-	Top	Top	Top	
	Quantity		EA	3	4	4	
	Air Flow Rate		m ³ /min	210 x 1 + 365 x 1	303 x 1 + 365 x 1	324 x 1 + 365 x 1	
			l/s	3,500 x 1 + 6,089 x 1	5,052 x 1 + 6,089 x 1	5,401 x 1 + 6,089 x 1	
	External Static Pressure	Max.	mmAq	8	11	11	
Pa			80	110	110		
Fan Motor	Type		-	BLDC Motor	BLDC Motor	BLDC Motor	
	Output		W x n	(630 x 1) x 1 + (620 x 2)	(620 x 2) x 2	(620 x 2) x 2	
Piping Connections	Liquid Pipe	Type		Braze connection	Braze connection	Braze connection	
		Φ, mm (inch)		19.05 (3/4)	19.05 (3/4)	19.05 (3/4)	
	Gas Pipe	Type		Braze connection	Braze connection	Braze connection	
		Φ, mm (inch)		41.28 (1-5/8)	41.28 (1-5/8)	41.28 (1-5/8)	
	Heat Insulation		-	Both liquid and gas pipes	Both liquid and gas pipes	Both liquid and gas pipes	

2. Specification

Standard

Model Name				AM380AXVAGH1EU	AM400AXVAGH1EU	AM420AXVAGH1EU
	Outdoor unit module 1			AM140AXVAGH/EU	AM160AXVAGH/EU	AM180AXVAGH/EU
	Outdoor unit module 2			AM240AXVAGH/EU	AM240AXVAGH/EU	AM240AXVAGH/EU
	Outdoor unit module 3			-	-	-
	Outdoor unit module 4			-	-	-
Piping Connections	Piping length (ODU-IDU)	Max. [Equiv.]	m	200[220]	200[220]	200[220]
	Piping length (1st Branch-IDU)	Max.	m	90	90	90
	Total piping length (System)	Max.	m	1,000	1,000	1,000
	Level difference (ODU in highest position)	Max.	m	110	110	110
	Level difference (IDU in highest position)	Max.	m	110	110	110
Wiring connections	Transmission Cable	Min.	mm ²	0.75	0.75	0.75
		Remark	-	F1, F2	F1, F2	F1, F2
	Power supply intake		-	Both indoor and outdoor unit	Both indoor and outdoor unit	Both indoor and outdoor unit
Refrigerant	Type		-	R410A	R410A	R410A
	Factory Charging		kg	7.0 x 1 + 14.0 x 1	8.0 x 1 + 14.0 x 1	8.0 x 1 + 14.0 x 1
			tCO ₂ e	43.85	45.94	45.94
Sound	Sound Pressure	Cooling	dB(A)	67	66	66
		Heating	dB(A)	69	68	69
	Sound Power		dB(A)	89	88	88
External Dimension	Net Weight		kg	207 x 1 + 325 x 1	242 x 1 + 325 x 1	242 x 1 + 325 x 1
	Shipping Weight		kg	221 x 1 + 342 x 1	259 x 1 + 342 x 1	259 x 1 + 342 x 1
	Net Dimensions (WxHxD)		mm	(930 x 1,695 x 765) x 1 + (1,295 x 1,695 x 765) x 1	(1,295 x 1,695 x 765) x 2	(1,295 x 1,695 x 765) x 2
	Shipping Dimensions (WxHxD)		mm	(998 x 1,887 x 829) x 1 + (1,363 x 1,887 x 829) x 1	(1,363 x 1,887 x 829) x 2	(1,363 x 1,887 x 829) x 2
Operating Temp. Range	Cooling		°C	-5 ~ 50	-5 ~ 50	-5 ~ 50
	Heating		°C	-25 ~ 24	-25 ~ 24	-25 ~ 24

NOTE

- Specification may be subject to change without prior notice.
- Specification comply with EN14825 and Eurovent test condition
- 1) Performances are based on the following test conditions.
 - Cooling : Indoor temperature 27°CDB, 19°CWB, Outdoor temperature 35°CDB, 24°CWB
 - Heating : Indoor temperature 20°CDB, 15°CWB, Outdoor temperature 7°CDB, 6°CWB
 - Equivalent refrigerant pipe length 5m, Level differences 0m
 - Refer to EUROVENT website(www.eurovent-certification.com) for other indoor unit combination and more detail test conditions.
- 2) Performance of Multiple Module Outdoor unit is weighted average of Single Module outdoor units.
- 3) Allowed combination ratio of the total rated indoor unit capacity over the rated outdoor unit capacity is 50~130%.
- 4) Sound pressure level is obtained in an anechoic room.
 - Sound pressure level is a relative value, depending on the distance and acoustic environment.
 - Sound pressure level may differ depending on operation condition.
 - dBA = A-weighted sound pressure level
 - Reference acoustic pressure 0 dB = 20uPa
- 5) Sound power level is an absolute value that a sound source generates.
 - dBA = A-weighted sound power level
 - Reference power : 1pW
 - Measured according to ISO 3741
- 6) Sound values of multi combination are theoretical values based on sound results of individual installed units.
- 7) These products contain R410A (GWP=2,088) which is fluorinated greenhouse gas.
- 8) If outdoor unit is located in a higher position than indoor unit, level difference is 110m or under.
 - (If the level difference is higher than 50m, make a decision by PDM kit installation Guide software whether the PDM kit should be installed or not.)
 - PDM kit: Pressure Drop Modulation kit
 - When the outdoor unit is below the indoor unit & the level differences are 40m or more, contact your local dealer for more information.
- 9) In case you want to know more information regarding capacity and correction, please refer to capacity table TDB on pvi.samsung.com site.
- 10) Recommended combination

* Ducted

Capacity	Indoor Units	Capacity	Indoor Units
8HP	AM056ANHPKH×4	18HP	AM056ANHPKH×4 + AM071ANHPKH×4
10HP	AM071ANHPKH×4	20HP	AM071ANHPKH×8
12HP	AM056ANHPKH×6	22HP	AM071ANHPKH×4 + AM090ANHPKH×4
14HP	AM056ANHPKH×1 + AM071ANHPKH×5	24HP	AM071ANHPKH×1 + AM090ANLDKH×7
16HP	AM056ANHPKH×2 + AM090ANHPKH×4	26HP	AM090ANLDKH×6 + AM112ANLDKH×2

* Non-ducted

Capacity	Indoor Units	Capacity	Indoor Units
8HP	AM028ANPKH + AM056ANPKH×2 + AM090ANPKH	18HP	AM028ANPKH + AM056ANPKH + AM056ANPKH + AM056ANPKH×2 + AM090ANPKH×2 + AM128ANPKH
10HP	AM056ANPKH×2 + AM090ANPKH×2	20HP	AM028ANPKH + AM056ANPKH×2 + AM090ANPKH×2 + AM128ANPKH
12HP	AM028ANPKH×2 + AM056ANPKH×2 + AM090ANPKH×2	22HP	AM028ANPKH + AM056ANPKH + AM056ANPKH + AM071ANPKH + AM090ANPKH + AM128ANPKH
14HP	AM028ANPKH + AM056ANPKH + AM056ANPKH + AM071ANPKH + AM090ANPKH + AM128ANPKH	24HP	AM071ANPKH + AM128ANPKH×2 + AM128ANPKH×3
16HP	AM028ANPKH + AM056ANPKH + AM090ANPKH×3 + AM128ANPKH	26HP	AM071ANPKH + AM128ANPKH + AM128ANPKH×4

2. Specification

Standard

Model Name				AM440AXVAGH1EU	AM460AXVAGH1EU	AM480AXVAGH1EU	
				Outdoor unit module 1	AM200AXVAGH/EU	AM220AXVAGH/EU	AM240AXVAGH/EU
				Outdoor unit module 2	AM240AXVAGH/EU	AM240AXVAGH/EU	AM240AXVAGH/EU
				Outdoor unit module 3	-	-	-
				Outdoor unit module 4	-	-	-
Power Supply			Ø, #, V, Hz	3, 4, 380-415, 50	3, 4, 380-415, 50	3, 4, 380-415, 50	
Mode			-	HEAT PUMP	HEAT PUMP	HEAT PUMP	
Performance	HP		HP	44	46	48	
	Capacity	Cooling(Rated)	kW	123.2	128.8	134.4	
		Heating(Rated)	kW	123.2	128.8	134.4	
		Heating(Max)	kW	138.6	144.9	151.2	
Maximum number of connectable indoor units			EA	64	64	64	
Total capacity of the connected Indoor Units		Min.	kW	61.6	64.4	67.2	
		Max.	kW	160.2	167.4	174.7	
Current	Current Input (Ducted)	Cooling(Rated)	A	89.92	95.48	100.10	
		Heating(Rated)	A	72.07	73.69	91.16	
	Current Input (Non-Ducted)	Cooling(Rated)	A	86.14	88.84	97.70	
		Heating(Rated)	A	71.53	72.94	91.16	
	Current	Minimum Ssc	MVA	16.3	16.7	18.6	
		MCA	A	98.0	101.0	110.0	
		MFA	A	125	125	125	
Efficiency	SEER	Ducted	W/W	-	-	-	
	SCOP		W/W	-	-	-	
	ηs.c		%	-	-	-	
	ηs.h	%	-	-	-		
	SEER	Non_Ducted	W/W	-	-	-	
	SCOP		W/W	-	-	-	
	ηs.c		%	-	-	-	
	ηs.h		%	-	-	-	
	Pdesignh		kW	60.1	61.1	62	
Casing	Material	Body	-	GI Steel Plate	GI Steel Plate	GI Steel Plate	
		Base	-	GI Steel Plate	GI Steel Plate	GI Steel Plate	
Heat Exchanger	Type		-	Fin & Tube	Fin & Tube	Fin & Tube	
	Material	Fin	-	Al	Al	Al	
		Tube	-	Cu	Cu	Cu	
	Fin Treatment		-	Anti-corrosion	Anti-corrosion	Anti-corrosion	
Compressor	Type		-	Inverter Scroll x 3	Inverter Scroll x 4	Inverter Scroll x 4	
	Output		kW x n	(8.93 x 1) x 1 + (6.67 x 2) x 1	(6.67 x 2) x 2	(6.67 x 2) x 2	
	Model Name		-	(DS4GM7090FV* x 1) x 1 + (DS4GR7066FV* x 2) x 1	(DS4GR7066FV* x 2) x 2	(DS4GR7066FV* x 2) x 2	
	Oil	Type		-	PVE	PVE	PVE
		Initial charge		cc x n	(1,400 x 1) x 1 + (1,100 x 2) x 1	(1,100 x 2) x 2	(1,100 x 2) x 2
Fan	Type		-	Propeller	Propeller	Propeller	
	Discharge direction		-	Top	Top	Top	
	Quantity		EA	4	4	4	
	Air Flow Rate		m³/min	313 x 1 + 365 x 1	342 x 1 + 365 x 1	365 x 2	
			l/s	5,209 x 1 + 6,089 x 1	5,698 x 1 + 6,089 x 1	6,089 x 2	
	External Static Pressure	Max.	mmAq	11	11	8	
Pa			110	110	80		
Fan Motor	Type		-	BLDC Motor	BLDC Motor	BLDC Motor	
	Output		W x n	(620 x 2) x 2	(620 x 2) x 2	(620 x 2) x 2	
Piping Connections	Liquid Pipe	Type		Braze connection	Braze connection	Braze connection	
		Φ, mm (inch)		19.05 (3/4)	19.05 (3/4)	19.05 (3/4)	
	Gas Pipe	Type		Braze connection	Braze connection	Braze connection	
		Φ, mm (inch)		41.28 (1-5/8)	41.28 (1-5/8)	41.28 (1-5/8)	
	Heat Insulation		-	Both liquid and gas pipes	Both liquid and gas pipes	Both liquid and gas pipes	

2. Specification

Standard

Model Name				AM440AXVAGH1EU	AM460AXVAGH1EU	AM480AXVAGH1EU
	Outdoor unit module 1			AM200AXVAGH/EU	AM220AXVAGH/EU	AM240AXVAGH/EU
	Outdoor unit module 2			AM240AXVAGH/EU	AM240AXVAGH/EU	AM240AXVAGH/EU
	Outdoor unit module 3			-	-	-
	Outdoor unit module 4			-	-	-
Piping Connections	Piping length (ODU-IDU)	Max. [Equiv.]	m	200[220]	200[220]	200[220]
	Piping length (1st Branch-IDU)	Max.	m	90	90	90
	Total piping length (System)	Max.	m	1,000	1,000	1,000
	Level difference (ODU in highest position)	Max.	m	110	110	110
	Level difference (IDU in highest position)	Max.	m	110	110	110
Wiring connections	Transmission Cable	Min.	mm ²	0.75	0.75	0.75
		Remark	-	F1, F2	F1, F2	F1, F2
	Power supply intake		-	Both indoor and outdoor unit	Both indoor and outdoor unit	Both indoor and outdoor unit
Refrigerant	Type		-	R410A	R410A	R410A
	Factory Charging		kg	10.5 x 1 + 14.0 x 1	10.5 x 1 + 14.0 x 1	14.0 x 2
			tCO ₂ e	51.16	51.16	58.46
Sound	Sound Pressure	Cooling	dB(A)	66	68	68
		Heating	dB(A)	68	69	70
	Sound Power		dB(A)	89	90	90
External Dimension	Net Weight		kg	268 x 1 + 325 x 1	301 x 1 + 325 x 1	325 x 2
	Shipping Weight		kg	285 x 1 + 342 x 1	318 x 1 + 342 x 1	342 x 2
	Net Dimensions (WxHxD)		mm	(1,295 x 1,695 x 765) x 2	(1,295 x 1,695 x 765) x 2	(1,295 x 1,695 x 765) x 2
	Shipping Dimensions (WxHxD)		mm	(1,363 x 1,887 x 829) x 2	(1,363 x 1,887 x 829) x 2	(1,363 x 1,887 x 829) x 2
Operating Temp. Range	Cooling		°C	-5 ~ 50	-5 ~ 50	-5 ~ 50
	Heating		°C	-25 ~ 24	-25 ~ 24	-25 ~ 24

NOTE

- Specification may be subject to change without prior notice.
- Specification comply with EN14825 and Eurovent test condition
- 1) Performances are based on the following test conditions.
 - Cooling : Indoor temperature 27°CDB, 19°CWB, Outdoor temperature 35°CDB, 24°CWB
 - Heating : Indoor temperature 20°CDB, 15°CWB, Outdoor temperature 7°CDB, 6°CWB
 - Equivalent refrigerant pipe length 5m, Level differences 0m
 - Refer to EUROVENT website(www.eurovent-certification.com) for other indoor unit combination and more detail test conditions.
- 2) Performance of Multiple Module Outdoor unit is weighted average of Single Module outdoor units.
- 3) Allowed combination ratio of the total rated indoor unit capacity over the rated outdoor unit capacity is 50~130%.
- 4) Sound pressure level is obtained in an anechoic room.
 - Sound pressure level is a relative value, depending on the distance and acoustic environment.
 - Sound pressure level may differ depending on operation condition.
 - dBA = A-weighted sound pressure level
 - Reference acoustic pressure 0 dB = 20uPa
- 5) Sound power level is an absolute value that a sound source generates.
 - dBA = A-weighted sound power level
 - Reference power : 1pW
 - Measured according to ISO 3741
- 6) Sound values of multi combination are theoretical values based on sound results of individual installed units.
- 7) These products contain R410A (GWP=2,088) which is fluorinated greenhouse gas.
- 8) If outdoor unit is located in a higher position than indoor unit, level difference is 110m or under.
 - (If the level difference is higher than 50m, make a decision by PDM kit installation Guide software whether the PDM kit should be installed or not.)
 - PDM kit: Pressure Drop Modulation kit
 - When the outdoor unit is below the indoor unit & the level differences are 40m or more, contact your local dealer for more information.
- 9) In case you want to know more information regarding capacity and correction, please refer to capacity table TDB on pvi.samsung.com site.
- 10) Recommended combination

* Ducted

Capacity	Indoor Units	Capacity	Indoor Units
8HP	AM056ANHPKH×4	18HP	AM056ANHPKH×4 + AM071ANHPKH×4
10HP	AM071ANHPKH×4	20HP	AM071ANHPKH×8
12HP	AM056ANHPKH×6	22HP	AM071ANHPKH×4 + AM090ANHPKH×4
14HP	AM056ANHPKH×1 + AM071ANHPKH×5	24HP	AM071ANHPKH×1 + AM090ANLDKH×7
16HP	AM056ANHPKH×2 + AM090ANHPKH×4	26HP	AM090ANLDKH×6 + AM112ANLDKH×2

* Non-ducted

Capacity	Indoor Units	Capacity	Indoor Units
8HP	AM028ANPKH + AM056ANPKH×2 + AM090ANPKH	18HP	AM028ANPKH + AM056ANPKH + AM056ANPKH + AM056ANPKH×2 + AM090ANPKH×2 + AM128ANPKH
10HP	AM056ANPKH×2 + AM090ANPKH×2	20HP	AM028ANPKH + AM056ANPKH×2 + AM090ANPKH×2 + AM128ANPKH
12HP	AM028ANPKH×2 + AM056ANPKH×2 + AM090ANPKH×2	22HP	AM028ANPKH + AM056ANPKH + AM056ANPKH + AM071ANPKH + AM090ANPKH + AM128ANPKH
14HP	AM028ANPKH + AM056ANPKH + AM056ANPKH + AM071ANPKH + AM090ANPKH + AM128ANPKH	24HP	AM028ANPKH + AM128ANPKH×2 + AM128ANPKH×3
16HP	AM028ANPKH + AM056ANPKH + AM090ANPKH×2 + AM128ANPKH	26HP	AM071ANPKH + AM128ANPKH + AM128ANPKH×4

2. Specification

Standard

Model Name				AM500AXVAGH1EU	AM520AXVAGH1EU	AM540AXVAGH1EU		
				Outdoor unit module 1		AM260AXVAGH/EU	AM260AXVAGH/EU	AM120AXVAGH/EU
				Outdoor unit module 2		AM240AXVAGH/EU	AM260AXVAGH/EU	AM180AXVAGH/EU
				Outdoor unit module 3		-	-	AM240AXVAGH/EU
				Outdoor unit module 4		-	-	-
Power Supply			Ø, #, V, Hz	3, 4, 380-415, 50	3, 4, 380-415, 50	3, 4, 380-415, 50		
Mode			-	HEAT PUMP	HEAT PUMP	HEAT PUMP		
Performance	HP		HP	50	52	54		
	Capacity	Cooling(Rated)	kW	140.0	145.6	151.2		
		Heating(Rated)	kW	135.2	136.0	151.2		
		Heating(Max)	kW	157.5	163.8	170.1		
Maximum number of connectable indoor units			EA	64	64	64		
Total capacity of the connected Indoor Units		Min.	kW	70.0	72.8	75.6		
		Max.	kW	182.0	189.3	196.6		
Current	Current Input (Ducted)	Cooling(Rated)	A	108.88	117.66	103.75		
		Heating(Rated)	A	92.12	93.08	82.69		
	Current Input (Non-Ducted)	Cooling(Rated)	A	107.68	117.66	102.23		
		Heating(Rated)	A	92.12	93.08	83.68		
	Current	Minimum Ssc	MVA	19.5	20.4	19.6		
		MCA	A	115.0	120.0	119.2		
MFA		A	150	150	150			
Efficiency	SEER	Ducted	W/W	-	-	-		
	SCOP		W/W	-	-	-		
	ηs.c		%	-	-	-		
	ηs.h		%	-	-	-		
	SEER	Non_Ducted	W/W	-	-	-		
	SCOP		W/W	-	-	-		
	ηs.c		%	-	-	-		
	ηs.h		%	-	-	-		
Pdesignh		kW	63	64	76.3			
Casing	Material	Body	-	GI Steel Plate	GI Steel Plate	GI Steel Plate		
		Base	-	GI Steel Plate	GI Steel Plate	GI Steel Plate		
Heat Exchanger	Type		-	Fin & Tube	Fin & Tube	Fin & Tube		
	Material	Fin	-	Al	Al	Al		
		Tube	-	Cu	Cu	Cu		
Fin Treatment			-	Anti-corrosion	Anti-corrosion	Anti-corrosion		
Compressor	Type		-	Inverter Scroll x 4	Inverter Scroll x 4	Inverter Scroll x 4		
	Output		kW x n	(6.67 x 2) x 2	(6.67 x 2) x 2	(6.67 x 1) x 1 + (8.93 x 1) x 1 + (6.67 x 2) x 1		
	Model Name		-	(DS4GR7066FV* x 2) x 2	(DS4GR7066FV* x 2) x 2	(DS4GR7066FV* x 1) x 1 + (DS4GM7090FV* x 1) x 1 + (DS4GR7066FV* x 2) x 1		
	Oil	Type	-	PVE	PVE	PVE		
Initial charge		cc x n	(1,100 x 2) x 2	(1,100 x 2) x 2	(1,100 x 1) x 1 + (1,400 x 1) x 1 + (1,100 x 2) x 1			
Fan	Type		-	Propeller	Propeller	Propeller		
	Discharge direction		-	Top	Top	Top		
	Quantity		EA	4	4	5		
	Air Flow Rate		m³/min	365 x 2	365 x 2	196 x 1 + 324 x 1 + 365 x 1		
			l/s	6,089 x 2	6,089 x 2	3,260 x 1 + 5,401 x 1 + 6,089 x 1		
	External Static Pressure	Max.	mmAq	8	8	11		
Pa			80	80	110			
Fan Motor	Type		-	BLDC Motor	BLDC Motor	BLDC Motor		
	Output		W x n	(620 x 2) x 2	(620 x 2) x 2	(630 x 1) x 1 + (620 x 2)		
Piping Connections	Liquid Pipe		Type	Braze connection	Braze connection	Braze connection		
			Φ, mm (inch)	19.05 (3/4)	19.05 (3/4)	19.05 (3/4)		
	Gas Pipe		Type	Braze connection	Braze connection	Braze connection		
			Φ, mm (inch)	41.28 (1-5/8)	41.28 (1-5/8)	41.28 (1-5/8)		
	Heat Insulation		-	Both liquid and gas pipes	Both liquid and gas pipes	Both liquid and gas pipes		

2. Specification

Standard

Model Name				AM500AXVAGH1EU	AM520AXVAGH1EU	AM540AXVAGH1EU
Outdoor unit module 1				AM260AXVAGH/EU	AM260AXVAGH/EU	AM120AXVAGH/EU
Outdoor unit module 2				AM240AXVAGH/EU	AM260AXVAGH/EU	AM180AXVAGH/EU
Outdoor unit module 3				-	-	AM240AXVAGH/EU
Outdoor unit module 4				-	-	-
Piping Connections	Piping length (ODU-IDU)	Max. [Equiv.]	m	200[220]	200[220]	200[220]
Connections	Piping length (1st Branch-IDU)	Max.	m	90	90	90
	Total piping length (System)	Max.	m	1,000	1,000	1,000
	Level difference (ODU in highest position)	Max.	m	110	110	110
	Level difference (IDU in highest position)	Max.	m	110	110	110
	Level difference (IDU-IDU)	Max.	m	50	50	50
Wiring connections	Transmission Cable	Min.	mm ²	0.75	0.75	0.75
		Remark	-	F1, F2	F1, F2	F1, F2
	Power supply intake		-	Both indoor and outdoor unit	Both indoor and outdoor unit	Both indoor and outdoor unit
Refrigerant	Type		-	R410A	R410A	R410A
	Factory Charging		kg	14.0 x 2	14.0 x 2	7.0 x 1 + 8.0 x 1 + 14.0 x 1
			tCO ₂ e		58.46	58.46
Sound	Sound Pressure	Cooling	dB(A)	68	68	68
		Heating	dB(A)	70	70	70
	Sound Power		dB(A)	90	90	89
External Dimension	Net Weight		kg	325 x 2	325 x 2	205 x 1 + 242 x 1 + 325 x 1
	Shipping Weight		kg	342 x 2	342 x 2	219 x 1 + 259 x 1 + 342 x 1
	Net Dimensions (WxHxD)		mm	(1,295 x 1,695 x 765) x 2	(1,295 x 1,695 x 765) x 2	(930 x 1,695 x 765) x 1 + (1,295 x 1,695 x 765) x 2
	Shipping Dimensions (WxHxD)		mm	(1,363 x 1,887 x 829) x 2	(1,363 x 1,887 x 829) x 2	(998 x 1,887 x 829) x 1 + (1,363 x 1,887 x 829) x 2
Operating Temp. Range	Cooling		°C	-5 ~ 50	-5 ~ 50	-5 ~ 50
	Heating		°C	-25 ~ 24	-25 ~ 24	-25 ~ 24

NOTE

- Specification may be subject to change without prior notice.
 - Specification comply with EN14825 and Eurovent test condition
- 1) Performances are based on the following test conditions.
 - Cooling : Indoor temperature 27°CDB, 19°CWB, Outdoor temperature 35°CDB, 24°CWB
 - Heating : Indoor temperature 20°CDB, 15°CWB, Outdoor temperature 7°CDB, 6°CWB
 - Equivalent refrigerant pipe length 5m, Level differences 0m
 - Refer to EUROVENT website(www.eurovent-certification.com) for other indoor unit combination and more detail test conditions.
 - 2) Performance of Multiple Module Outdoor unit is weighted average of Single Module outdoor units.
 - 3) Allowed combination ratio of the total rated indoor unit capacity over the rated outdoor unit capacity is 50~130%.
 - 4) Sound pressure level is obtained in an anechoic room.
 - Sound pressure level is a relative value, depending on the distance and acoustic environment.
 - Sound pressure level may differ depending on operation condition.
 - dBA = A-weighted sound pressure level
 - Reference acoustic pressure 0 dB = 20uPa
 - 5) Sound power level is an absolute value that a sound source generates.
 - dBA = A-weighted sound power level
 - Reference power: 1pW
 - Measured according to ISO 3741
 - 6) Sound values of multi combination are theoretical values based on sound results of individual installed units.
 - 7) These products contain R410A (GWP=2,088) which is fluorinated greenhouse gas.
 - 8) If outdoor unit is located in a higher position than indoor unit, level difference is 110m or under.
 - (If the level difference is higher than 50m, make a decision by PDM kit installation Guide software whether the PDM kit should be installed or not.)
 - PDM kit: Pressure Drop Modulation kit
 - When the outdoor unit is below the indoor unit & the level differences are 40m or more, contact your local dealer for more information.
 - 9) In case you want to know more information regarding capacity and correction, please refer to capacity table TDB on pvi.samsung.com site.
 - 10) Recommended combination

* Ducted

Capacity	Indoor Units	Capacity	Indoor Units
8HP	AM056ANHPKH×4	18HP	AM056ANHPKH×4 + AM071ANHPKH×4
10HP	AM071ANHPKH×4	20HP	AM071ANHPKH×8
12HP	AM056ANHPKH×6	22HP	AM071ANHPKH×4 + AM090ANHPKH×4
14HP	AM056ANHPKH×1 + AM071ANHPKH×5	24HP	AM071ANHPKH×1 + AM090ANLDKH×7
16HP	AM056ANHPKH×2 + AM090ANHPKH×4	26HP	AM090ANLDKH×6 + AM112ANLDKH×2

* Non-ducted

Capacity	Indoor Units	Capacity	Indoor Units
8HP	AM028ANPKH + AM056ANPKH×2 + AM090ANPKH	18HP	AM028ANPKH + AM056ANPKH + AM056ANPKH + AM056ANPKH×2 + AM090ANPKH×2 + AM128ANPKH
10HP	AM056ANPKH×2 + AM090ANPKH×2	20HP	AM028ANPKH + AM056ANPKH×2 + AM090ANPKH×2 + AM128ANPKH
12HP	AM028ANPKH×2 + AM056ANPKH×2 + AM090ANPKH×2	22HP	AM028ANPKH + AM056ANPKH + AM056ANPKH + AM090ANPKH + AM128ANPKH
14HP	AM028ANPKH + AM056ANPKH + AM056ANPKH + AM071ANPKH + AM090ANPKH + AM128ANPKH	24HP	AM028ANPKH + AM128ANPKH×2 + AM128ANPKH×3
16HP	AM028ANPKH + AM056ANPKH + AM090ANPKH×3 + AM128ANPKH	26HP	AM071ANPKH + AM128ANPKH + AM128ANPKH×4

2. Specification

Standard

Model Name				AM560AXVAGH1EU	AM580AXVAGH1EU	AM600AXVAGH1EU	
				Outdoor unit module 1	AM080AXVAGH/EU	AM100AXVAGH/EU	AM120AXVAGH/EU
				Outdoor unit module 2	AM240AXVAGH/EU	AM240AXVAGH/EU	AM240AXVAGH/EU
				Outdoor unit module 3	AM240AXVAGH/EU	AM240AXVAGH/EU	AM240AXVAGH/EU
				Outdoor unit module 4	-	-	-
Power Supply			Ø, #, V, Hz	3, 4, 380-415, 50	3, 4, 380-415, 50	3, 4, 380-415, 50	
Mode			-	HEAT PUMP	HEAT PUMP	HEAT PUMP	
Performance	HP		HP	56	58	60	
	Capacity	Cooling(Rated)	kW	156.8	162.4	168.0	
		Heating(Rated)	kW	156.8	162.4	168.0	
		Heating(Max)	kW	176.4	182.7	189.0	
Maximum number of connectable indoor units			EA	64	64	64	
Total capacity of the connected Indoor Units		Min.	kW	78.4	81.2	84.0	
		Max.	kW	203.8	211.1	218.4	
Current	Current Input (Ducted)	Cooling(Rated)	A	112.70	118.51	119.93	
		Heating(Rated)	A	100.66	104.06	105.98	
	Current Input (Non-Ducted)	Cooling(Rated)	A	108.63	113.00	116.00	
		Heating(Rated)	A	100.15	103.20	105.84	
	Current	Minimum Ssc	MVA	21.6	22.3	22.6	
		MCA	A	128.0	133.0	135.0	
MFA		A	150	150	150		
Efficiency	SEER	Ducted	W/W	-	-	-	
	SCOP		W/W	-	-	-	
	ηs.c		%	-	-	-	
	ηs.h		%	-	-	-	
	SEER	Non_Ducted	W/W	-	-	-	
	SCOP		W/W	-	-	-	
	ηs.c		%	-	-	-	
	ηs.h		%	-	-	-	
Pdesignh		kW	75.7	78.3	80.8		
Casing	Material	Body	-	GI Steel Plate	GI Steel Plate	GI Steel Plate	
		Base	-	GI Steel Plate	GI Steel Plate	GI Steel Plate	
Heat Exchanger	Type		-	Fin & Tube	Fin & Tube	Fin & Tube	
	Material	Fin	-	Al	Al	Al	
		Tube	-	Cu	Cu	Cu	
Fin Treatment			-	Anti-corrosion	Anti-corrosion	Anti-corrosion	
Compressor	Type		-	Inverter Scroll x 5	Inverter Scroll x 5	Inverter Scroll x 5	
	Output		kW x n	(4.60 x 1) x 1 + (6.67 x 2) x 2	(6.67 x 1) x 1 + (6.67 x 2) x 2	(6.67 x 1) x 1 + (6.67 x 2) x 2	
	Model Name		-	(DS2GR7046FV* x 1) x 1 + (DS4GR7066FV* x 2) x 2	(DS4GR7066FV* x 1) x 1 + (DS4GR7066FV* x 2) x 2	(DS4GR7066FV* x 1) x 1 + (DS4GR7066FV* x 2) x 2	
	Oil	Type	-	PVE	PVE	PVE	
Initial charge		cc x n	(900 x 1) x 1 + (1,100 x 2) x 2	(1,100 x 1) x 1 + (1,100 x 2) x 2	(1,100 x 1) x 1 + (1,100 x 2) x 2		
Fan	Type		-	Propeller	Propeller	Propeller	
	Discharge direction		-	Top	Top	Top	
	Quantity		EA	5	5	5	
	Air Flow Rate		m ³ /min	151 x 1 + 365 x 2	167 x 1 + 365 x 2	196 x 1 + 365 x 2	
			l/s	2,515 x 1 + 6,089 x 2	2,779 x 1 + 6,089 x 2	3,260 x 1 + 6,089 x 2	
	External Static Pressure	Max.	mmAq	11	11	11	
Pa			110	110	110		
Fan Motor	Type		-	BLDC Motor	BLDC Motor	BLDC Motor	
	Output		W x n	(630 x 1) x 1 + (620 x 2)	(630 x 1) x 1 + (620 x 2)	(630 x 1) x 1 + (620 x 2)	
Piping Connections	Liquid Pipe	Type		Braze connection	Braze connection	Braze connection	
		Φ, mm (inch)		19.05 (3/4)	19.05 (3/4)	19.05 (3/4)	
	Gas Pipe	Type		Braze connection	Braze connection	Braze connection	
		Φ, mm (inch)		41.28 (1-5/8)	41.28 (1-5/8)	41.28 (1-5/8)	
	Heat Insulation		-	Both liquid and gas pipes	Both liquid and gas pipes	Both liquid and gas pipes	

2. Specification

Standard

Model Name				AM560AXVAGH1EU	AM580AXVAGH1EU	AM600AXVAGH1EU
	Outdoor unit module 1			AM080AXVAGH/EU	AM100AXVAGH/EU	AM120AXVAGH/EU
	Outdoor unit module 2			AM240AXVAGH/EU	AM240AXVAGH/EU	AM240AXVAGH/EU
	Outdoor unit module 3			AM240AXVAGH/EU	AM240AXVAGH/EU	AM240AXVAGH/EU
	Outdoor unit module 4			-	-	-
Piping Connections	Piping length (ODU-IDU)	Max. [Equiv.]	m	200[220]	200[220]	200[220]
	Piping length (1st Branch-IDU)	Max.	m	90	90	90
	Total piping length (System)	Max.	m	1,000	1,000	1,000
	Level difference (ODU in highest position)	Max.	m	110	110	110
	Level difference (IDU in highest position)	Max.	m	110	110	110
	Level difference (IDU-IDU)	Max.	m	50	50	50
Wiring connections	Transmission Cable	Min.	mm ²	0.75	0.75	0.75
		Remark	-	F1, F2	F1, F2	F1, F2
	Power supply intake		-	Both indoor and outdoor unit	Both indoor and outdoor unit	Both indoor and outdoor unit
Refrigerant	Type		-	R410A	R410A	R410A
	Factory Charging		kg	5.5 x 1 + 14.0 x 2	5.5 x 1 + 14.0 x 2	7.0 x 1 + 14.0 x 2
			tCO ₂ e		69.95	69.95
Sound	Sound Pressure	Cooling	dB(A)	68	68	69
		Heating	dB(A)	70	70	71
	Sound Power		dB(A)	90	90	91
External Dimension	Net Weight		kg	175 x 1 + 325 x 2	185 x 1 + 325 x 2	205 x 1 + 325 x 2
	Shipping Weight		kg	189 x 1 + 342 x 2	199 x 1 + 342 x 2	219 x 1 + 342 x 2
	Net Dimensions (WxHxD)		mm	(930 x 1,695 x 765) x 1 + (1,295 x 1,695 x 765) x 2	(930 x 1,695 x 765) x 1 + (1,295 x 1,695 x 765) x 2	(930 x 1,695 x 765) x 1 + (1,295 x 1,695 x 765) x 2
	Shipping Dimensions (WxHxD)		mm	(998 x 1,887 x 829) x 1 + (1,363 x 1,887 x 829) x 2	(998 x 1,887 x 829) x 1 + (1,363 x 1,887 x 829) x 2	(998 x 1,887 x 829) x 1 + (1,363 x 1,887 x 829) x 2
Operating Temp. Range	Cooling		°C	-5 ~ 50	-5 ~ 50	-5 ~ 50
	Heating		°C	-25 ~ 24	-25 ~ 24	-25 ~ 24

NOTE

- Specification may be subject to change without prior notice.
- Specification comply with EN14825 and Eurovent test condition
- 1) Performances are based on the following test conditions.
 - Cooling : Indoor temperature 27°CDB, 19°CWB, Outdoor temperature 35°CDB, 24°CWB
 - Heating : Indoor temperature 20°CDB, 15°CWB, Outdoor temperature 7°CDB, 6°CWB
 - Equivalent refrigerant pipe length 5m, Level differences 0m
 - Refer to EUROVENT website(www.eurovent-certification.com) for other indoor unit combination and more detail test conditions.
- 2) Performance of Multiple Module Outdoor unit is weighted average of Single Module outdoor units.
- 3) Allowed combination ratio of the total rated indoor unit capacity over the rated outdoor unit capacity is 50~130%.
- 4) Sound pressure level is obtained in an anechoic room.
 - Sound pressure level is a relative value, depending on the distance and acoustic environment.
 - Sound pressure level may differ depending on operation condition.
 - dBA = A-weighted sound pressure level
 - Reference acoustic pressure 0 dB = 20uPa
- 5) Sound power level is an absolute value that a sound source generates.
 - dBA = A-weighted sound power level
 - Reference power: 1pW
 - Measured according to ISO 3741
- 6) Sound values of multi combination are theoretical values based on sound results of individual installed units.
- 7) These products contain R410A (GWP=2,088) which is fluorinated greenhouse gas.
- 8) If outdoor unit is located in a higher position than indoor unit, level difference is 110m or under.
 - (If the level difference is higher than 50m, make a decision by PDM kit installation Guide software whether the PDM kit should be installed or not.)
 - PDM kit: Pressure Drop Modulation kit
 - When the outdoor unit is below the indoor unit & the level differences are 40m or more, contact your local dealer for more information.
- 9) In case you want to know more information regarding capacity and correction, please refer to capacity table TDB on pvi.samsung.com site.
- 10) Recommended combination

* Ducted

Capacity	Indoor Units	Capacity	Indoor Units
8HP	AM056ANHPKH×4	18HP	AM056ANHPKH×4 + AM071ANHPKH×4
10HP	AM071ANHPKH×4	20HP	AM071ANHPKH×8
12HP	AM056ANHPKH×6	22HP	AM071ANHPKH×4 + AM090ANHPKH×4
14HP	AM056ANHPKH×1 + AM071ANHPKH×5	24HP	AM071ANHPKH×1 + AM090ANLDKH×7
16HP	AM056ANHPKH×2 + AM090ANHPKH×4	26HP	AM090ANLDKH×6 + AM112ANLDKH×2

* Non-ducted

Capacity	Indoor Units	Capacity	Indoor Units
8HP	AM028ANPKH + AM056ANPKH×2 + AM090ANPKH	18HP	AM028ANPKH + AM056ANPKH + AM056ANPKH + AM056ANPKH×2 + AM090ANPKH×2 + AM128ANPKH
10HP	AM056ANPKH×2 + AM090ANPKH×2	20HP	AM028ANPKH + AM056ANPKH×2 + AM090ANPKH×2 + AM128ANPKH
12HP	AM028ANPKH×2 + AM056ANPKH×2 + AM090ANPKH×2	22HP	AM028ANPKH + AM056ANPKH + AM056ANPKH + AM090ANPKH + AM128ANPKH
14HP	AM028ANPKH + AM056ANPKH + AM056ANPKH + AM071ANPKH + AM090ANPKH + AM128ANPKH	24HP	AM028ANPKH + AM128ANPKH×2 + AM128ANPKH×3
16HP	AM028ANPKH + AM056ANPKH + AM090ANPKH×3 + AM128ANPKH	26HP	AM071ANPKH + AM128ANPKH + AM128ANPKH×4

2. Specification

Standard

Model Name				AM620AXVAGH1EU	AM640AXVAGH1EU	AM660AXVAGH1EU	
				Outdoor unit module 1	AM140AXVAGH/EU	AM160AXVAGH/EU	AM180AXVAGH/EU
				Outdoor unit module 2	AM240AXVAGH/EU	AM240AXVAGH/EU	AM240AXVAGH/EU
				Outdoor unit module 3	AM240AXVAGH/EU	AM240AXVAGH/EU	AM240AXVAGH/EU
				Outdoor unit module 4	-	-	-
Power Supply			Ø, #, V, Hz	3, 4, 380-415, 50	3, 4, 380-415, 50	3, 4, 380-415, 50	
Mode			-	HEAT PUMP	HEAT PUMP	HEAT PUMP	
Performance	HP		HP	62	64	66	
	Capacity	Cooling(Rated)	kW	174.4	179.4	184.8	
		Heating(Rated)	kW	174.4	179.4	184.8	
		Heating(Max)	kW	196.2	201.6	207.9	
Maximum number of connectable indoor units			EA	64	64	64	
Total capacity of the connected Indoor Units		Min.	kW	87.2	89.7	92.4	
		Max.	kW	226.7	233.2	240.2	
Current	Current Input (Ducted)	Cooling(Rated)	A	127.82	129.57	133.97	
		Heating(Rated)	A	109.97	111.29	113.45	
	Current Input (Non-Ducted)	Cooling(Rated)	A	122.14	125.64	132.78	
		Heating(Rated)	A	109.47	110.56	114.58	
	Current	Minimum Ssc	MVA	23.2	23.8	24.9	
		MCA	A	139.0	142.0	149.2	
		MFA	A	175	175	175	
Efficiency	SEER	Ducted	W/W	-	-	-	
	SCOP		W/W	-	-	-	
	ηs.c		%	-	-	-	
	ηs.h	%	-	-	-		
	SEER	Non_Ducted	W/W	-	-	-	
	SCOP		W/W	-	-	-	
	ηs.c		%	-	-	-	
	ηs.h	%	-	-	-		
	Pdesignh		kW	82.3	86	88.5	
Casing	Material	Body	-	GI Steel Plate	GI Steel Plate	GI Steel Plate	
		Base	-	GI Steel Plate	GI Steel Plate	GI Steel Plate	
Heat Exchanger	Type		-	Fin & Tube	Fin & Tube	Fin & Tube	
	Material	Fin	-	Al	Al	Al	
		Tube	-	Cu	Cu	Cu	
	Fin Treatment			-	Anti-corrosion	Anti-corrosion	Anti-corrosion
Compressor	Type			-	Inverter Scroll x 5	Inverter Scroll x 5	Inverter Scroll x 5
	Output		kW x n	(6.67 x 1) x 1 + (6.67 x 2) x 2	(8.93 x 1) x 1 + (6.67 x 2) x 2	(8.93 x 1) x 1 + (6.67 x 2) x 2	
	Model Name		-	(DS4GR7066FV* x 1) x 1 + (DS4GR7066FV* x 2) x 2	(DS4GM7090FV* x 1) x 1 + (DS4GR7066FV* x 2) x 2	(DS4GM7090FV* x 1) x 1 + (DS4GR7066FV* x 2) x 2	
	Oil	Type	-	PVE	PVE	PVE	
		Initial charge	cc x n	(1,100 x 1) x 1 + (1,100 x 2) x 2	(1,400 x 1) x 1 + (1,100 x 2) x 2	(1,400 x 1) x 1 + (1,100 x 2) x 2	
Fan	Type			-	Propeller	Propeller	Propeller
	Discharge direction			-	Top	Top	Top
	Quantity		EA	5	6	6	
	Air Flow Rate		m³/min	210 x 1 + 365 x 2	303 x 1 + 365 x 2	324 x 1 + 365 x 2	
			l/s	3,500 x 1 + 6,089 x 2	5,052 x 1 + 6,089 x 2	5,401 x 1 + 6,089 x 2	
	External Static Pressure	Max.	mmAq	8	11	11	
Pa			80	110	110		
Fan Motor	Type			-	BLDC Motor	BLDC Motor	BLDC Motor
	Output		W x n	(630 x 1) x 1 + (620 x 2)	(620 x 2) x 3	(620 x 2) x 3	
Piping Connections	Liquid Pipe		Type	Braze connection	Braze connection	Braze connection	
			Φ, mm (inch)	22.22 (7/8)	22.22 (7/8)	22.22 (7/8)	
	Gas Pipe		Type	Braze connection	Braze connection	Braze connection	
			Φ, mm (inch)	53.98 (2-1/8)	53.98 (2-1/8)	53.98 (2-1/8)	
	Heat Insulation			-	Both liquid and gas pipes	Both liquid and gas pipes	Both liquid and gas pipes

2. Specification

Standard

Model Name				AM620AXVAGH1EU	AM640AXVAGH1EU	AM660AXVAGH1EU
	Outdoor unit module 1			AM140AXVAGH/EU	AM160AXVAGH/EU	AM180AXVAGH/EU
	Outdoor unit module 2			AM240AXVAGH/EU	AM240AXVAGH/EU	AM240AXVAGH/EU
	Outdoor unit module 3			AM240AXVAGH/EU	AM240AXVAGH/EU	AM240AXVAGH/EU
	Outdoor unit module 4			-	-	-
Piping Connections	Piping length (ODU-IDU)	Max. [Equiv.]	m	200[220]	200[220]	200[220]
	Piping length (1st Branch-IDU)	Max.	m	90	90	90
	Total piping length (System)	Max.	m	1,000	1,000	1,000
	Level difference (ODU in highest position)	Max.	m	110	110	110
	Level difference (IDU in highest position)	Max.	m	110	110	110
	Level difference (IDU-IDU)	Max.	m	50	50	50
Wiring connections	Transmission Cable	Min.	mm ²	0.75	0.75	0.75
		Remark	-	F1, F2	F1, F2	F1, F2
	Power supply intake		-	Both indoor and outdoor unit	Both indoor and outdoor unit	Both indoor and outdoor unit
Refrigerant	Type		-	R410A	R410A	R410A
	Factory Charging		kg	7.0 x 1 + 14.0 x 2	8.0 x 1 + 14.0 x 2	8.0 x 1 + 14.0 x 2
			tCO ₂ e		73.08	75.17
Sound	Sound Pressure	Cooling	dB(A)	69	69	69
		Heating	dB(A)	71	71	71
	Sound Power		dB(A)	91	91	91
External Dimension	Net Weight		kg	207 x 1 + 325 x 2	242 x 1 + 325 x 2	242 x 1 + 325 x 2
	Shipping Weight		kg	221 x 1 + 342 x 2	259 x 1 + 342 x 2	259 x 1 + 342 x 2
	Net Dimensions (WxHxD)		mm	(930 x 1,695 x 765) x 1 + (1,295 x 1,695 x 765) x 2	(1,295 x 1,695 x 765) x 3	(1,295 x 1,695 x 765) x 3
	Shipping Dimensions (WxHxD)		mm	(998 x 1,887 x 829) x 1 + (1,363 x 1,887 x 829) x 2	(1,363 x 1,887 x 829) x 3	(1,363 x 1,887 x 829) x 3
Operating Temp. Range	Cooling		°C	-5 ~ 50	-5 ~ 50	-5 ~ 50
	Heating		°C	-25 ~ 24	-25 ~ 24	-25 ~ 24

NOTE

- Specification may be subject to change without prior notice.
- Specification comply with EN14825 and Eurovent test condition
- 1) Performances are based on the following test conditions.
 - Cooling : Indoor temperature 27°CDB, 19°CWB, Outdoor temperature 35°CDB, 24°CWB
 - Heating : Indoor temperature 20°CDB, 15°CWB, Outdoor temperature 7°CDB, 6°CWB
 - Equivalent refrigerant pipe length 5m, Level differences 0m
 - Refer to EUROVENT website(www.eurovent-certification.com) for other indoor unit combination and more detail test conditions.
- 2) Performance of Multiple Module Outdoor unit is weighted average of Single Module outdoor units.
- 3) Allowed combination ratio of the total rated indoor unit capacity over the rated outdoor unit capacity is 50~130%.
- 4) Sound pressure level is obtained in an anechoic room.
 - Sound pressure level is a relative value, depending on the distance and acoustic environment.
 - Sound pressure level may differ depending on operation condition.
 - dBA = A-weighted sound pressure level
 - Reference acoustic pressure 0 dB = 20uPa
- 5) Sound power level is an absolute value that a sound source generates.
 - dBA = A-weighted sound power level
 - Reference power: 1pW
 - Measured according to ISO 3741
- 6) Sound values of multi combination are theoretical values based on sound results of individual installed units.
- 7) These products contain R410A (GWP=2,088) which is fluorinated greenhouse gas.
- 8) If outdoor unit is located in a higher position than indoor unit, level difference is 110m or under.
 - (If the level difference is higher than 50m, make a decision by PDM kit installation Guide software whether the PDM kit should be installed or not.)
 - PDM kit: Pressure Drop Modulation kit
 - When the outdoor unit is below the indoor unit & the level differences are 40m or more, contact your local dealer for more information.
- 9) In case you want to know more information regarding capacity and correction, please refer to capacity table TDB on pvi.samsung.com site.
- 10) Recommended combination

* Ducted

Capacity	Indoor Units	Capacity	Indoor Units
8HP	AM056ANHPKH×4	18HP	AM056ANHPKH×4 + AM071ANHPKH×4
10HP	AM071ANHPKH×4	20HP	AM071ANHPKH×8
12HP	AM056ANHPKH×6	22HP	AM071ANHPKH×4 + AM090ANHPKH×4
14HP	AM056ANHPKH×1 + AM071ANHPKH×5	24HP	AM071ANHPKH×1 + AM090ANLDKH×7
16HP	AM056ANHPKH×2 + AM090ANHPKH×4	26HP	AM090ANLDKH×6 + AM112ANLDKH×2

* Non-ducted

Capacity	Indoor Units	Capacity	Indoor Units
8HP	AM028ANPKH + AM056ANPKH×2 + AM090ANPKH	18HP	AM028ANPKH + AM056ANPKH + AM056ANPKH + AM056ANPKH×2 + AM090ANPKH×2 + AM128ANPKH
10HP	AM056ANPKH×2 + AM090ANPKH×2	20HP	AM028ANPKH + AM056ANPKH×2 + AM090ANPKH×2 + AM128ANPKH
12HP	AM028ANPKH×2 + AM056ANPKH×2 + AM090ANPKH×2	22HP	AM028ANPKH + AM056ANPKH + AM056ANPKH + AM071ANPKH + AM090ANPKH + AM128ANPKH
14HP	AM028ANPKH + AM056ANPKH + AM056ANPKH + AM071ANPKH + AM090ANPKH + AM128ANPKH	24HP	AM071ANPKH + AM128ANPKH×2 + AM128ANPKH×3
16HP	AM028ANPKH + AM056ANPKH + AM090ANPKH×3 + AM128ANPKH	26HP	AM071ANPKH + AM128ANPKH + AM128ANPKH×4

2. Specification

Standard

Model Name				AM680AXVAGH1EU	AM700AXVAGH1EU	AM720AXVAGH1EU	
				Outdoor unit module 1	AM200AXVAGH/EU	AM220AXVAGH/EU	AM240AXVAGH/EU
				Outdoor unit module 2	AM240AXVAGH/EU	AM240AXVAGH/EU	AM240AXVAGH/EU
				Outdoor unit module 3	AM240AXVAGH/EU	AM240AXVAGH/EU	AM240AXVAGH/EU
				Outdoor unit module 4	-	-	-
Power Supply			Ø, #, V, Hz	3, 4, 380-415, 50	3, 4, 380-415, 50	3, 4, 380-415, 50	
Mode			-	HEAT PUMP	HEAT PUMP	HEAT PUMP	
Performance	HP		HP	68	70	72	
	Capacity	Cooling(Rated)	kW	190.4	196.0	201.6	
		Heating(Rated)	kW	190.4	196.0	201.6	
		Heating(Max)	kW	214.2	220.5	226.8	
Maximum number of connectable indoor units			EA	64	64	64	
Total capacity of the connected Indoor Units		Min.	kW	95.2	98.0	100.8	
		Max.	kW	247.5	254.8	262.1	
Current	Current Input (Ducted)	Cooling(Rated)	A	139.97	145.53	150.15	
		Heating(Rated)	A	117.65	119.27	136.74	
	Current Input (Non-Ducted)	Cooling(Rated)	A	134.99	137.69	146.55	
		Heating(Rated)	A	117.11	118.52	136.74	
	Current	Minimum Ssc	MVA	25.6	26.0	27.9	
		MCA	A	153.0	156.0	165.0	
MFA		A	175	175	200		
Efficiency	SEER	Ducted	W/W	-	-	-	
	SCOP		W/W	-	-	-	
	ηs.c		%	-	-	-	
	ηs.h		%	-	-	-	
	SEER	Non_Ducted	W/W	-	-	-	
	SCOP		W/W	-	-	-	
	ηs.c		%	-	-	-	
	ηs.h		%	-	-	-	
Pdesignh		kW	91.1	92.1	93		
Casing	Material	Body	-	GI Steel Plate	GI Steel Plate	GI Steel Plate	
		Base	-	GI Steel Plate	GI Steel Plate	GI Steel Plate	
Heat Exchanger	Type		-	Fin & Tube	Fin & Tube	Fin & Tube	
	Material	Fin	-	Al	Al	Al	
		Tube	-	Cu	Cu	Cu	
Fin Treatment			-	Anti-corrosion	Anti-corrosion	Anti-corrosion	
Compressor	Type		-	Inverter Scroll x 5	Inverter Scroll x 6	Inverter Scroll x 6	
	Output		kW x n	(8.93 x 1) x 1 + (6.67 x 2) x 2	(6.67 x 2) x 3	(6.67 x 2) x 3	
	Model Name		-	(DS4GM7090FV* x 1) x 1 + (DS4GR7066FV* x 2) x 2	(DS4GR7066FV* x 2) x 3	(DS4GR7066FV* x 2) x 3	
	Oil	Type	-	PVE	PVE	PVE	
Initial charge		cc x n	(1,400 x 1) x 1 + (1,100 x 2) x 2	(1,100 x 2) x 3	(1,100 x 2) x 3		
Fan	Type		-	Propeller	Propeller	Propeller	
	Discharge direction		-	Top	Top	Top	
	Quantity		EA	6	6	6	
	Air Flow Rate		m³/min	313 x 1 + 365 x 2	342 x 1 + 365 x 2	365 x 3	
			l/s	5,209 x 1 + 6,089 x 2	5,698 x 1 + 6,089 x 2	6,089 x 3	
	External Static Pressure	Max.	mmAq	11	11	8	
Pa			110	110	80		
Fan Motor	Type		-	BLDC Motor	BLDC Motor	BLDC Motor	
	Output		W x n	(620 x 2) x 3	(620 x 2) x 3	(620 x 2) x 3	
Piping Connections	Liquid Pipe		Type	Braze connection	Braze connection	Braze connection	
			Φ, mm (inch)	22.22 (7/8)	22.22 (7/8)	22.22 (7/8)	
	Gas Pipe		Type	Braze connection	Braze connection	Braze connection	
			Φ, mm (inch)	53.98 (2-1/8)	53.98 (2-1/8)	53.98 (2-1/8)	
Heat Insulation			-	Both liquid and gas pipes	Both liquid and gas pipes	Both liquid and gas pipes	

2. Specification

Standard

Model Name				AM680AXVAGH1EU	AM700AXVAGH1EU	AM720AXVAGH1EU
	Outdoor unit module 1			AM200AXVAGH/EU	AM220AXVAGH/EU	AM240AXVAGH/EU
	Outdoor unit module 2			AM240AXVAGH/EU	AM240AXVAGH/EU	AM240AXVAGH/EU
	Outdoor unit module 3			AM240AXVAGH/EU	AM240AXVAGH/EU	AM240AXVAGH/EU
	Outdoor unit module 4			-	-	-
Piping Connections	Piping length (ODU-IDU)	Max. [Equiv.]	m	200[220]	200[220]	200[220]
	Piping length (1st Branch-IDU)	Max.	m	90	90	90
	Total piping length (System)	Max.	m	1,000	1,000	1,000
	Level difference (ODU in highest position)	Max.	m	110	110	110
	Level difference (IDU in highest position)	Max.	m	110	110	110
	Level difference (IDU-IDU)	Max.	m	50	50	50
Wiring connections	Transmission Cable	Min.	mm ²	0.75	0.75	0.75
		Remark	-	F1, F2	F1, F2	F1, F2
	Power supply intake		-	Both indoor and outdoor unit	Both indoor and outdoor unit	Both indoor and outdoor unit
Refrigerant	Type		-	R410A	R410A	R410A
	Factory Charging		kg	10.5 x 1 + 14.0 x 2	10.5 x 1 + 14.0 x 2	14.0 x 3
			tCO ₂ e		80.39	80.39
Sound	Sound Pressure	Cooling	dB(A)	69	69	70
		Heating	dB(A)	71	71	72
	Sound Power		dB(A)	91	91	92
External Dimension	Net Weight		kg	268 x 1 + 325 x 2	301 x 1 + 325 x 2	325 x 3
	Shipping Weight		kg	285 x 1 + 342 x 2	318 x 1 + 342 x 2	342 x 3
	Net Dimensions (WxHxD)		mm	(1,295 x 1,695 x 765) x 3	(1,295 x 1,695 x 765) x 3	(1,295 x 1,695 x 765) x 3
	Shipping Dimensions (WxHxD)		mm	(1,363 x 1,887 x 829) x 3	(1,363 x 1,887 x 829) x 3	(1,363 x 1,887 x 829) x 3
Operating Temp. Range	Cooling		°C	-5 ~ 50	-5 ~ 50	-5 ~ 50
	Heating		°C	-25 ~ 24	-25 ~ 24	-25 ~ 24

NOTE

- Specification may be subject to change without prior notice.
- Specification comply with EN14825 and Eurovent test condition
- 1) Performances are based on the following test conditions.
 - Cooling : Indoor temperature 27°CDB, 19°CWB, Outdoor temperature 35°CDB, 24°CWB
 - Heating : Indoor temperature 20°CDB, 15°CWB, Outdoor temperature 7°CDB, 6°CWB
 - Equivalent refrigerant pipe length 5m, Level differences 0m
 - Refer to EUROVENT website(www.eurovent-certification.com) for other indoor unit combination and more detail test conditions.
- 2) Performance of Multiple Module Outdoor unit is weighted average of Single Module outdoor units.
- 3) Allowed combination ratio of the total rated indoor unit capacity over the rated outdoor unit capacity is 50~130%.
- 4) Sound pressure level is obtained in an anechoic room.
 - Sound pressure level is a relative value, depending on the distance and acoustic environment.
 - Sound pressure level may differ depending on operation condition.
 - dBA = A-weighted sound pressure level
 - Reference acoustic pressure 0 dB = 20uPa
- 5) Sound power level is an absolute value that a sound source generates.
 - dBA = A-weighted sound power level
 - Reference power : 1pW
 - Measured according to ISO 3741
- 6) Sound values of multi combination are theoretical values based on sound results of individual installed units.
- 7) These products contain R410A (GWP=2,088) which is fluorinated greenhouse gas.
- 8) If outdoor unit is located in a higher position than indoor unit, level difference is 110m or under.
 - (If the level difference is higher than 50m, make a decision by PDM kit installation Guide software whether the PDM kit should be installed or not.)
 - PDM kit: Pressure Drop Modulation kit
 - When the outdoor unit is below the indoor unit & the level differences are 40m or more, contact your local dealer for more information.
- 9) In case you want to know more information regarding capacity and correction, please refer to capacity table TDB on pvi.samsung.com site.
- 10) Recommended combination

* Ducted

Capacity	Indoor Units	Capacity	Indoor Units
8HP	AM056ANHPKH×4	18HP	AM056ANHPKH×4 + AM071ANHPKH×4
10HP	AM071ANHPKH×4	20HP	AM071ANHPKH×8
12HP	AM056ANHPKH×6	22HP	AM071ANHPKH×4 + AM090ANHPKH×4
14HP	AM056ANHPKH×1 + AM071ANHPKH×5	24HP	AM071ANHPKH×1 + AM090ANLDKH×7
16HP	AM056ANHPKH×2 + AM090ANHPKH×4	26HP	AM090ANLDKH×6 + AM112ANLDKH×2

* Non-ducted

Capacity	Indoor Units	Capacity	Indoor Units
8HP	AM028ANPKH + AM056ANPKH×2 + AM090ANPKH	18HP	AM028ANPKH + AM056ANPKH + AM056ANPKH + AM056ANPKH×2 + AM090ANPKH×2 + AM071ANPKH
10HP	AM056ANPKH×2 + AM090ANPKH×2	20HP	AM028ANPKH + AM056ANPKH×2 + AM090ANPKH×2 + AM090ANPKH×2 + AM071ANPKH
12HP	AM028ANPKH×2 + AM056ANPKH×2 + AM090ANPKH×2	22HP	AM028ANPKH + AM056ANPKH + AM056ANPKH + AM090ANPKH + AM071ANPKH + AM071ANPKH + AM071ANPKH
14HP	AM028ANPKH + AM056ANPKH + AM056ANPKH + AM071ANPKH + AM090ANPKH + AM128ANPKH	24HP	AM071ANPKH + AM128ANPKH×2 + AM128ANPKH×3
16HP	AM028ANPKH + AM056ANPKH + AM090ANPKH×3 + AM128ANPKH	26HP	AM071ANPKH + AM128ANPKH + AM128ANPKH×4

2. Specification

Standard

Model Name				AM740AXVAGH1EU	AM760AXVAGH1EU	AM780AXVAGH1EU			
				Outdoor unit module 1			AM260AXVAGH/EU	AM240AXVAGH/EU	AM260AXVAGH/EU
				Outdoor unit module 2			AM240AXVAGH/EU	AM260AXVAGH/EU	AM260AXVAGH/EU
				Outdoor unit module 3			AM240AXVAGH/EU	AM260AXVAGH/EU	AM260AXVAGH/EU
				Outdoor unit module 4			-	-	-
Power Supply			Ø, #, V, Hz	3, 4, 380-415, 50	3, 4, 380-415, 50	3, 4, 380-415, 50			
Mode			-	HEAT PUMP	HEAT PUMP	HEAT PUMP			
Performance	HP		HP	74	76	78			
	Capacity	Cooling(Rated)	kW	207.2	212.8	218.4			
		Heating(Rated)	kW	202.4	203.2	204.0			
		Heating(Max)	kW	233.1	239.4	245.7			
Maximum number of connectable indoor units			EA	64	64	64			
Total capacity of the connected Indoor Units		Min.	kW	103.6	106.4	109.2			
		Max.	kW	269.4	276.6	283.9			
Current	Current Input (Ducted)		Cooling(Rated)	A	158.93	167.71	176.49		
			Heating(Rated)	A	137.70	138.66	139.62		
	Current Input (Non-Ducted)		Cooling(Rated)	A	156.53	166.51	176.49		
			Heating(Rated)	A	137.70	138.66	139.62		
	Current		Minimum Ssc	MVA	28.8	29.7	30.6		
			MCA	A	170.0	175.0	180.0		
			MFA	A	200	200	200		
Efficiency	SEER	Ducted	W/W	-	-	-			
	SCOP		W/W	-	-	-			
	ηs.c		%	-	-	-			
	ηs.h	%	-	-	-				
	SEER	Non_Ducted	W/W	-	-	-			
	SCOP		W/W	-	-	-			
	ηs.c		%	-	-	-			
	ηs.h		%	-	-	-			
	Pdesignh		kW	94	95	96			
Casing	Material		Body	-	GI Steel Plate	GI Steel Plate	GI Steel Plate		
			Base	-	GI Steel Plate	GI Steel Plate	GI Steel Plate		
Heat Exchanger	Type		-	Fin & Tube	Fin & Tube	Fin & Tube			
	Material		Fin	-	Al	Al	Al		
			Tube	-	Cu	Cu	Cu		
Fin Treatment			-	Anti-corrosion	Anti-corrosion	Anti-corrosion			
Compressor	Type		-	Inverter Scroll x 6	Inverter Scroll x 6	Inverter Scroll x 6			
	Output		kW x n	(6.67 x 2) x 3	(6.67 x 2) x 3	(6.67 x 2) x 3			
	Model Name		-	(DS4GR7066FV* x 2) x 3	(DS4GR7066FV* x 2) x 3	(DS4GR7066FV* x 2) x 3			
	Oil		Type	-	PVE	PVE	PVE		
			Initial charge	cc x n	(1,100 x 2) x 3	(1,100 x 2) x 3	(1,100 x 2) x 3		
Fan	Type		-	Propeller	Propeller	Propeller			
	Discharge direction		-	Top	Top	Top			
	Quantity		EA	6	6	6			
	Air Flow Rate		m³/min	365 x 3	365 x 3	365 x 3			
			l/s	6,089 x 3	6,089 x 3	6,089 x 3			
	External Static Pressure		Max.	mmAq	8	8	8		
Pa			80	80	80				
Fan Motor	Type		-	BLDC Motor	BLDC Motor	BLDC Motor			
	Output		W x n	(620 x 2) x 3	(620 x 2) x 3	(620 x 2) x 3			
Piping Connections	Liquid Pipe		Type	Braze connection	Braze connection	Braze connection			
			Φ, mm (inch)	22.22 (7/8)	22.22 (7/8)	22.22 (7/8)			
	Gas Pipe		Type	Braze connection	Braze connection	Braze connection			
			Φ, mm (inch)	53.98 (2-1/8)	53.98 (2-1/8)	53.98 (2-1/8)			
Heat Insulation			-	Both liquid and gas pipes	Both liquid and gas pipes	Both liquid and gas pipes			

2. Specification

Standard

Model Name				AM740AXVAGH1EU	AM760AXVAGH1EU	AM780AXVAGH1EU
	Outdoor unit module 1			AM260AXVAGH/EU	AM240AXVAGH/EU	AM260AXVAGH/EU
	Outdoor unit module 2			AM240AXVAGH/EU	AM260AXVAGH/EU	AM260AXVAGH/EU
	Outdoor unit module 3			AM240AXVAGH/EU	AM260AXVAGH/EU	AM260AXVAGH/EU
	Outdoor unit module 4			-	-	-
Piping Connections	Piping length (ODU-IDU)	Max. [Equiv.]	m	200[220]	200[220]	200[220]
	Piping length (1st Branch-IDU)	Max.	m	90	90	90
	Total piping length (System)	Max.	m	1,000	1,000	1,000
	Level difference (ODU in highest position)	Max.	m	110	110	110
	Level difference (IDU in highest position)	Max.	m	110	110	110
	Level difference (IDU-IDU)	Max.	m	50	50	50
Wiring connections	Transmission Cable	Min.	mm ²	0.75	0.75	0.75
		Remark	-	F1, F2	F1, F2	F1, F2
	Power supply intake		-	Both indoor and outdoor unit	Both indoor and outdoor unit	Both indoor and outdoor unit
Refrigerant	Type		-	R410A	R410A	R410A
	Factory Charging		kg	14.0 x 3	14.0 x 3	14.0 x 3
			tCO ₂ e		87.70	87.70
Sound	Sound Pressure	Cooling	dB(A)	70	70	70
		Heating	dB(A)	72	72	72
	Sound Power		dB(A)	92	92	92
External Dimension	Net Weight		kg	325 x 3	325 x 3	325 x 3
	Shipping Weight		kg	342 x 3	342 x 3	342 x 3
	Net Dimensions (WxHxD)		mm	(1,295 x 1,695 x 765) x 3	(1,295 x 1,695 x 765) x 3	(1,295 x 1,695 x 765) x 3
	Shipping Dimensions (WxHxD)		mm	(1,363 x 1,887 x 829) x 3	(1,363 x 1,887 x 829) x 3	(1,363 x 1,887 x 829) x 3
Operating Temp. Range	Cooling		°C	-5 ~ 50	-5 ~ 50	-5 ~ 50
	Heating		°C	-25 ~ 24	-25 ~ 24	-25 ~ 24

NOTE

- Specification may be subject to change without prior notice.
- Specification comply with EN14825 and Eurovent test condition
- 1) Performances are based on the following test conditions.
 - Cooling : Indoor temperature 27°CDB, 19°CWB, Outdoor temperature 35°CDB, 24°CWB
 - Heating : Indoor temperature 20°CDB, 15°CWB, Outdoor temperature 7°CDB, 6°CWB
 - Equivalent refrigerant pipe length 5m, Level differences 0m
 - Refer to EUROVENT website(www.eurovent-certification.com) for other indoor unit combination and more detail test conditions.
- 2) Performance of Multiple Module Outdoor unit is weighted average of Single Module outdoor units.
- 3) Allowed combination ratio of the total rated indoor unit capacity over the rated outdoor unit capacity is 50~130%.
- 4) Sound pressure level is obtained in an anechoic room.
 - Sound pressure level is a relative value, depending on the distance and acoustic environment.
 - Sound pressure level may differ depending on operation condition.
 - dBA = A-weighted sound pressure level
 - Reference acoustic pressure 0 dB = 20uPa
- 5) Sound power level is an absolute value that a sound source generates.
 - dBA = A-weighted sound power level
 - Reference power: 1pW
 - Measured according to ISO 3741
- 6) Sound values of multi combination are theoretical values based on sound results of individual installed units.
- 7) These products contain R410A (GWP=2,088) which is fluorinated greenhouse gas.
- 8) If outdoor unit is located in a higher position than indoor unit, level difference is 110m or under.
 - (If the level difference is higher than 50m, make a decision by PDM kit installation Guide software whether the PDM kit should be installed or not.)
 - PDM kit: Pressure Drop Modulation kit
 - When the outdoor unit is below the indoor unit & the level differences are 40m or more, contact your local dealer for more information.
- 9) In case you want to know more information regarding capacity and correction, please refer to capacity table TDB on pvi.samsung.com site.
- 10) Recommended combination

* Ducted

Capacity	Indoor Units	Capacity	Indoor Units
8HP	AM056ANHPKH×4	18HP	AM056ANHPKH×4 + AM071ANHPKH×4
10HP	AM071ANHPKH×4	20HP	AM071ANHPKH×8
12HP	AM056ANHPKH×6	22HP	AM071ANHPKH×4 + AM090ANHPKH×4
14HP	AM056ANHPKH×1 + AM071ANHPKH×5	24HP	AM071ANHPKH×1 + AM090ANLDKH×7
16HP	AM056ANHPKH×2 + AM090ANHPKH×4	26HP	AM090ANLDKH×6 + AM112ANLDKH×2

* Non-ducted

Capacity	Indoor Units	Capacity	Indoor Units
8HP	AM028ANPKH + AM056ANPKH×2 + AM090ANPKH	18HP	AM028ANPKH + AM056ANPKH + AM056ANPKH + AM056ANPKH×2 + AM090ANPKH×2 + AM071ANPKH
10HP	AM056ANPKH×2 + AM090ANPKH×2	20HP	AM028ANPKH + AM056ANPKH×2 + AM090ANPKH×2 + AM056ANPKH×4 + AM071ANPKH
12HP	AM028ANPKH×2 + AM056ANPKH×2 + AM090ANPKH×2	22HP	AM028ANPKH + AM056ANPKH + AM056ANPKH + AM056ANPKH + AM071ANPKH + AM090ANPKH + AM128ANPKH
14HP	AM028ANPKH + AM056ANPKH + AM056ANPKH + AM071ANPKH + AM090ANPKH + AM128ANPKH	24HP	AM071ANPKH + AM128ANPKH×2 + AM128ANPKH×3
16HP	AM028ANPKH + AM056ANPKH + AM090ANPKH×3 + AM128ANPKH	26HP	AM071ANPKH + AM128ANPKH + AM128ANPKH×4

2. Specification

Standard

Model Name				AM800AXVAGH1EU	AM820AXVAGH1EU	AM840AXVAGH1EU		
				Outdoor unit module 1		AM080AXVAGH/EU	AM100AXVAGH/EU	AM120AXVAGH/EU
				Outdoor unit module 2		AM240AXVAGH/EU	AM240AXVAGH/EU	AM240AXVAGH/EU
				Outdoor unit module 3		AM240AXVAGH/EU	AM240AXVAGH/EU	AM240AXVAGH/EU
				Outdoor unit module 4		AM240AXVAGH/EU	AM240AXVAGH/EU	AM240AXVAGH/EU
Power Supply			Ø, #, V, Hz	3, 4, 380-415, 50	3, 4, 380-415, 50	3, 4, 380-415, 50		
Mode			-	HEAT PUMP	HEAT PUMP	HEAT PUMP		
Performance	HP		HP	80	82	84		
	Capacity	Cooling(Rated)	kW	224.0	229.6	235.2		
		Heating(Rated)	kW	224.0	229.6	235.2		
		Heating(Max)	kW	252.0	258.3	264.6		
Maximum number of connectable indoor units			EA	64	64	64		
Total capacity of the connected Indoor Units		Min.	kW	112.0	114.8	117.6		
		Max.	kW	291.2	298.5	305.8		
Current	Current Input (Ducted)	Cooling(Rated)	A	162.75	168.56	169.98		
		Heating(Rated)	A	146.24	149.64	151.56		
	Current Input (Non-Ducted)	Cooling(Rated)	A	157.48	161.85	164.85		
		Heating(Rated)	A	145.73	148.78	151.42		
	Current	Minimum Ssc	MVA	30.9	31.6	31.9		
		MCA	A	183.0	188.0	190.0		
		MFA	A	225	225	225		
Efficiency	SEER	Ducted	W/W	-	-	-		
	SCOP		W/W	-	-	-		
	ηs.c		%	-	-	-		
	ηs.h		%	-	-	-		
	SEER	Non_Ducted	W/W	-	-	-		
	SCOP		W/W	-	-	-		
	ηs.c		%	-	-	-		
	ηs.h		%	-	-	-		
Pdesignh		kW	106.7	109.3	111.8			
Casing	Material	Body	-	GI Steel Plate	GI Steel Plate	GI Steel Plate		
		Base	-	GI Steel Plate	GI Steel Plate	GI Steel Plate		
Heat Exchanger	Type		-	Fin & Tube	Fin & Tube	Fin & Tube		
	Material	Fin	-	Al	Al	Al		
		Tube	-	Cu	Cu	Cu		
	Fin Treatment			-	Anti-corrosion	Anti-corrosion	Anti-corrosion	
Compressor	Type			-	Inverter Scroll x 7	Inverter Scroll x 7	Inverter Scroll x 7	
	Output		kW x n	(4.60 x 1) x 1 + (6.67 x 2) x 3	(6.67 x 1) x 1 + (6.67 x 2) x 3	(6.67 x 1) x 1 + (6.67 x 2) x 3		
	Model Name			-	(DS2GR7046FV* x 1) x 1 + (DS4GR7066FV* x 2) x 3	(DS4GR7066FV* x 1) x 1 + (DS4GR7066FV* x 2) x 3	(DS4GR7066FV* x 1) x 1 + (DS4GR7066FV* x 2) x 3	
	Oil	Type		-	PVE	PVE	PVE	
		Initial charge	cc x n	(900 x 1) x 1 + (1,100 x 2) x 3	(1,100 x 1) x 1 + (1,100 x 2) x 3	(1,100 x 1) x 1 + (1,100 x 2) x 3		
Fan	Type			-	Propeller	Propeller	Propeller	
	Discharge direction			-	Top	Top	Top	
	Quantity		EA	7	7	7		
	Air Flow Rate		m³/min	151 x 1 + 365 x 3	167 x 1 + 365 x 3	196 x 1 + 365 x 3		
			l/s	2,515 x 1 + 6,089 x 3	2,779 x 1 + 6,089 x 3	3,260 x 1 + 6,089 x 3		
	External Static Pressure	Max.	mmAq	11	11	11		
Pa			110	110	110			
Fan Motor	Type			-	BLDC Motor	BLDC Motor	BLDC Motor	
	Output		W x n	(630 x 1) x 1 + (620 x 2)	(630 x 1) x 1 + (620 x 2)	(630 x 1) x 1 + (620 x 2)		
Piping Connections	Liquid Pipe		Type	Braze connection	Braze connection	Braze connection		
			Φ, mm (inch)	22.22 (7/8)	22.22 (7/8)	22.22 (7/8)		
	Gas Pipe		Type	Braze connection	Braze connection	Braze connection		
			Φ, mm (inch)	53.98 (2-1/8)	53.98 (2-1/8)	53.98 (2-1/8)		
	Heat Insulation			-	Both liquid and gas pipes	Both liquid and gas pipes	Both liquid and gas pipes	

2. Specification

Standard

Model Name				AM800AXVAGH1EU	AM820AXVAGH1EU	AM840AXVAGH1EU
	Outdoor unit module 1			AM080AXVAGH/EU	AM100AXVAGH/EU	AM120AXVAGH/EU
	Outdoor unit module 2			AM240AXVAGH/EU	AM240AXVAGH/EU	AM240AXVAGH/EU
	Outdoor unit module 3			AM240AXVAGH/EU	AM240AXVAGH/EU	AM240AXVAGH/EU
	Outdoor unit module 4			AM240AXVAGH/EU	AM240AXVAGH/EU	AM240AXVAGH/EU
Piping Connections	Piping length (ODU-IDU)	Max. [Equiv.]	m	200[220]	200[220]	200[220]
	Piping length (1st Branch-IDU)	Max.	m	90	90	90
	Total piping length (System)	Max.	m	1,000	1,000	1,000
	Level difference (ODU in highest position)	Max.	m	110	110	110
	Level difference (IDU in highest position)	Max.	m	110	110	110
	Level difference (IDU-IDU)	Max.	m	50	50	50
Wiring connections	Transmission Cable	Min.	mm ²	0.75	0.75	0.75
		Remark	-	F1, F2	F1, F2	F1, F2
	Power supply intake		-	Both indoor and outdoor unit	Both indoor and outdoor unit	Both indoor and outdoor unit
Refrigerant	Type		-	R410A	R410A	R410A
	Factory Charging		kg	5.5 x 1 + 14.0 x 3	5.5 x 1 + 14.0 x 3	7.0 x 1 + 14.0 x 3
			tCO ₂ e	99.18	99.18	102.31
Sound	Sound Pressure	Cooling	dB(A)	70	70	70
		Heating	dB(A)	72	72	72
	Sound Power		dB(A)	92	92	92
External Dimension	Net Weight		kg	175 x 1 + 325 x 3	185 x 1 + 325 x 3	205 x 1 + 325 x 3
	Shipping Weight		kg	189 x 1 + 342 x 3	199 x 1 + 342 x 3	219 x 1 + 342 x 3
	Net Dimensions (WxHxD)		mm	(930 x 1,695 x 765) x 1 + (1,295 x 1,695 x 765) x 3	(930 x 1,695 x 765) x 1 + (1,295 x 1,695 x 765) x 3	(930 x 1,695 x 765) x 1 + (1,295 x 1,695 x 765) x 3
	Shipping Dimensions (WxHxD)		mm	(998 x 1,887 x 829) x 1 + (1,363 x 1,887 x 829) x 3	(998 x 1,887 x 829) x 1 + (1,363 x 1,887 x 829) x 3	(998 x 1,887 x 829) x 1 + (1,363 x 1,887 x 829) x 3
Operating Temp. Range	Cooling		°C	-5 ~ 50	-5 ~ 50	-5 ~ 50
	Heating		°C	-25 ~ 24	-25 ~ 24	-25 ~ 24

NOTE

- Specification may be subject to change without prior notice.
 - Specification comply with EN14825 and Eurovent test condition
- 1) Performances are based on the following test conditions.
 - Cooling : Indoor temperature 27°CDB, 19°CWB, Outdoor temperature 35°CDB, 24°CWB
 - Heating : Indoor temperature 20°CDB, 15°CWB, Outdoor temperature 7°CDB, 6°CWB
 - Equivalent refrigerant pipe length 5m, Level differences 0m
 - Refer to EUROVENT website(www.eurovent-certification.com) for other indoor unit combination and more detail test conditions.
 - 2) Performance of Multiple Module Outdoor unit is weighted average of Single Module outdoor units.
 - 3) Allowed combination ratio of the total rated indoor unit capacity over the rated outdoor unit capacity is 50~130%.
 - 4) Sound pressure level is obtained in an anechoic room.
 - Sound pressure level is a relative value, depending on the distance and acoustic environment.
 - Sound pressure level may differ depending on operation condition.
 - dBA = A-weighted sound pressure level
 - Reference acoustic pressure 0 dB = 20uPa
 - 5) Sound power level is an absolute value that a sound source generates.
 - dBA = A-weighted sound power level
 - Reference power : 1pW
 - Measured according to ISO 3741
 - 6) Sound values of multi combination are theoretical values based on sound results of individual installed units.
 - 7) These products contain R410A (GWP=2,088) which is fluorinated greenhouse gas.
 - 8) If outdoor unit is located in a higher position than indoor unit, level difference is 110m or under.
 - (If the level difference is higher than 50m, make a decision by PDM kit installation Guide software whether the PDM kit should be installed or not.)
 - PDM kit: Pressure Drop Modulation kit
 - When the outdoor unit is below the indoor unit & the level differences are 40m or more, contact your local dealer for more information.
 - 9) In case you want to know more information regarding capacity and correction, please refer to capacity table TDB on pvi.samsung.com site.
 - 10) Recommended combination

* Ducted

Capacity	Indoor Units	Capacity	Indoor Units
8HP	AM056ANHPKH×4	18HP	AM056ANHPKH×4 + AM071ANHPKH×4
10HP	AM071ANHPKH×4	20HP	AM071ANHPKH×8
12HP	AM056ANHPKH×6	22HP	AM071ANHPKH×4 + AM090ANHPKH×4
14HP	AM056ANHPKH×1 + AM071ANHPKH×5	24HP	AM071ANHPKH×1 + AM090ANLDKH×7
16HP	AM056ANHPKH×2 + AM090ANHPKH×4	26HP	AM090ANLDKH×6 + AM112ANLDKH×2

* Non-ducted

Capacity	Indoor Units	Capacity	Indoor Units
8HP	AM028ANPKH + AM056ANPKH×2 + AM090ANPKH	18HP	AM028ANPKH + AM056ANPKH + AM056ANPKH + AM056ANPKH×2 + AM090ANPKH×2 + AM128ANPKH
10HP	AM056ANPKH×2 + AM090ANPKH×2	20HP	AM028ANPKH + AM056ANPKH×2 + AM090ANPKH×2 + AM128ANPKH
12HP	AM028ANPKH×2 + AM056ANPKH×2 + AM090ANPKH×2	22HP	AM028ANPKH + AM056ANPKH + AM056ANPKH + AM071ANPKH + AM090ANPKH + AM128ANPKH
14HP	AM028ANPKH + AM056ANPKH + AM056ANPKH + AM071ANPKH + AM090ANPKH + AM128ANPKH	24HP	AM028ANPKH×5 + AM128ANPKH×2
16HP	AM028ANPKH + AM056ANPKH + AM090ANPKH×3 + AM128ANPKH	26HP	AM071ANPKH + AM128ANPKH×2 + AM128ANPKH×4

2. Specification

Standard

Model Name				AM860AXVAGH1EU	AM880AXVAGH1EU	AM900AXVAGH1EU	
			Outdoor unit module 1		AM140AXVAGH/EU	AM160AXVAGH/EU	AM180AXVAGH/EU
			Outdoor unit module 2		AM240AXVAGH/EU	AM240AXVAGH/EU	AM240AXVAGH/EU
			Outdoor unit module 3		AM240AXVAGH/EU	AM240AXVAGH/EU	AM240AXVAGH/EU
			Outdoor unit module 4		AM240AXVAGH/EU	AM240AXVAGH/EU	AM240AXVAGH/EU
Power Supply			Ø, #, V, Hz	3, 4, 380-415, 50	3, 4, 380-415, 50	3, 4, 380-415, 50	
Mode			-	HEAT PUMP	HEAT PUMP	HEAT PUMP	
Performance	HP		HP	86	88	90	
	Capacity	Cooling(Rated)	kW	241.6	246.6	252.0	
		Heating(Rated)	kW	241.6	246.6	252.0	
		Heating(Max)	kW	271.8	277.2	283.5	
Maximum number of connectable indoor units			EA	64	64	64	
Total capacity of the connected Indoor Units		Min.	kW	120.8	123.3	126.0	
		Max.	kW	314.1	320.6	327.6	
Current	Current Input (Ducted)	Cooling(Rated)	A	177.87	179.62	184.02	
		Heating(Rated)	A	155.55	156.87	159.03	
	Current Input (Non-Ducted)	Cooling(Rated)	A	170.99	174.49	181.63	
		Heating(Rated)	A	155.05	156.14	160.16	
	Current	Minimum Ssc	MVA	32.5	33.1	34.2	
		MCA	A	194.0	197.0	204.2	
		MFA	A	225	225	225	
Efficiency	SEER	Ducted	W/W	-	-	-	
	SCOP		W/W	-	-	-	
	ηs.c		%	-	-	-	
	ηs.h	%	-	-	-		
	SEER	Non_Ducted	W/W	-	-	-	
	SCOP		W/W	-	-	-	
	ηs.c		%	-	-	-	
	ηs.h		%	-	-	-	
	Pdesignh		kW	113.3	117	119.5	
Casing	Material	Body	-	GI Steel Plate	GI Steel Plate	GI Steel Plate	
		Base	-	GI Steel Plate	GI Steel Plate	GI Steel Plate	
Heat Exchanger	Type		-	Fin & Tube	Fin & Tube	Fin & Tube	
	Material	Fin	-	Al	Al	Al	
		Tube	-	Cu	Cu	Cu	
	Fin Treatment			-	Anti-corrosion	Anti-corrosion	Anti-corrosion
Compressor	Type			-	Inverter Scroll x 7	Inverter Scroll x 7	
	Output		kW x n	(6.67 x 1) x 1 + (6.67 x 2) x 3	(8.93 x 1) x 1 + (6.67 x 2) x 3	(8.93 x 1) x 1 + (6.67 x 2) x 3	
	Model Name		-	(DS4GR7066FV* x 1) x 1 + (DS4GR7066FV* x 2) x 3	(DS4GM7090FV* x 1) x 1 + (DS4GR7066FV* x 2) x 3	(DS4GM7090FV* x 1) x 1 + (DS4GR7066FV* x 2) x 3	
	Oil	Type	-	PVE	PVE	PVE	
		Initial charge	cc x n	(1,100 x 1) x 1 + (1,100 x 2) x 3	(1,400 x 1) x 1 + (1,100 x 2) x 3	(1,400 x 1) x 1 + (1,100 x 2) x 3	
Fan	Type			-	Propeller	Propeller	
	Discharge direction			-	Top	Top	
	Quantity		EA	7	8	8	
	Air Flow Rate		m³/min	210 x 1 + 365 x 3	303 x 1 + 365 x 3	324 x 1 + 365 x 3	
			l/s	3,500 x 1 + 6,089 x 3	5,052 x 1 + 6,089 x 3	5,401 x 1 + 6,089 x 3	
	External Static Pressure	Max.	mmAq	8	11	11	
Pa			80	110	110		
Fan Motor	Type			-	BLDC Motor	BLDC Motor	
	Output		W x n	(630 x 1) x 1 + (620 x 2)	(620 x 2) x 4	(620 x 2) x 4	
Piping Connections	Liquid Pipe		Type	Braze connection	Braze connection	Braze connection	
			Φ, mm (inch)	22.22 (7/8)	22.22 (7/8)	22.22 (7/8)	
	Gas Pipe		Type	Braze connection	Braze connection	Braze connection	
			Φ, mm (inch)	53.98 (2-1/8)	53.98 (2-1/8)	53.98 (2-1/8)	
	Heat Insulation			-	Both liquid and gas pipes	Both liquid and gas pipes	

2. Specification

Standard

Model Name				AM860AXVAGH1EU	AM880AXVAGH1EU	AM900AXVAGH1EU
	Outdoor unit module 1			AM140AXVAGH/EU	AM160AXVAGH/EU	AM180AXVAGH/EU
	Outdoor unit module 2			AM240AXVAGH/EU	AM240AXVAGH/EU	AM240AXVAGH/EU
	Outdoor unit module 3			AM240AXVAGH/EU	AM240AXVAGH/EU	AM240AXVAGH/EU
	Outdoor unit module 4			AM240AXVAGH/EU	AM240AXVAGH/EU	AM240AXVAGH/EU
Piping Connections	Piping length (ODU-IDU)	Max. [Equiv.]	m	200[220]	200[220]	200[220]
	Piping length (1st Branch-IDU)	Max.	m	90	90	90
	Total piping length (System)	Max.	m	1,000	1,000	1,000
	Level difference (ODU in highest position)	Max.	m	110	110	110
	Level difference (IDU in highest position)	Max.	m	110	110	110
	Level difference (IDU-IDU)	Max.	m	50	50	50
Wiring connections	Transmission Cable	Min.	mm ²	0.75	0.75	0.75
		Remark	-	F1, F2	F1, F2	F1, F2
	Power supply intake		-	Both indoor and outdoor unit	Both indoor and outdoor unit	Both indoor and outdoor unit
Refrigerant	Type		-	R410A	R410A	R410A
	Factory Charging		kg	7.0 x 1 + 14.0 x 3	8.0 x 1 + 14.0 x 3	8.0 x 1 + 14.0 x 3
			tCO ₂ e	102.31	104.40	104.40
Sound	Sound Pressure	Cooling	dB(A)	71	70	70
		Heating	dB(A)	73	72	72
	Sound Power		dB(A)	93	92	92
External Dimension	Net Weight		kg	207 x 1 + 325 x 3	242 x 1 + 325 x 3	242 x 1 + 325 x 3
	Shipping Weight		kg	221 x 1 + 342 x 3	259 x 1 + 342 x 3	259 x 1 + 342 x 3
	Net Dimensions (WxHxD)		mm	(930 x 1,695 x 765) x 1 + (1,295 x 1,695 x 765) x 3	(1,295 x 1,695 x 765) x 4	(1,295 x 1,695 x 765) x 4
	Shipping Dimensions (WxHxD)		mm	(998 x 1,887 x 829) x 1 + (1,363 x 1,887 x 829) x 3	(1,363 x 1,887 x 829) x 4	(1,363 x 1,887 x 829) x 4
Operating Temp. Range	Cooling		°C	-5 ~ 50	-5 ~ 50	-5 ~ 50
	Heating		°C	-25 ~ 24	-25 ~ 24	-25 ~ 24

NOTE

- Specification may be subject to change without prior notice.
- Specification comply with EN14825 and Eurovent test condition
- 1) Performances are based on the following test conditions.
 - Cooling : Indoor temperature 27°CDB, 19°CWB, Outdoor temperature 35°CDB, 24°CWB
 - Heating : Indoor temperature 20°CDB, 15°CWB, Outdoor temperature 7°CDB, 6°CWB
 - Equivalent refrigerant pipe length 5m, Level differences 0m
 - Refer to EUROVENT website(www.eurovent-certification.com) for other indoor unit combination and more detail test conditions.
- 2) Performance of Multiple Module Outdoor unit is weighted average of Single Module outdoor units.
- 3) Allowed combination ratio of the total rated indoor unit capacity over the rated outdoor unit capacity is 50~130%.
- 4) Sound pressure level is obtained in an anechoic room.
 - Sound pressure level is a relative value, depending on the distance and acoustic environment.
 - Sound pressure level may differ depending on operation condition.
 - dBA = A-weighted sound pressure level
 - Reference acoustic pressure 0 dB = 20uPa
- 5) Sound power level is an absolute value that a sound source generates.
 - dBA = A-weighted sound power level
 - Reference power: 1pW
 - Measured according to ISO 3741
- 6) Sound values of multi combination are theoretical values based on sound results of individual installed units.
- 7) These products contain R410A (GWP=2,088) which is fluorinated greenhouse gas.
- 8) If outdoor unit is located in a higher position than indoor unit, level difference is 110m or under.
 - (If the level difference is higher than 50m, make a decision by PDM kit installation Guide software whether the PDM kit should be installed or not.)
 - PDM kit: Pressure Drop Modulation kit
 - When the outdoor unit is below the indoor unit & the level differences are 40m or more, contact your local dealer for more information.
- 9) In case you want to know more information regarding capacity and correction, please refer to capacity table TDB on pvi.samsung.com site.
- 10) Recommended combination

* Ducted

Capacity	Indoor Units	Capacity	Indoor Units
8HP	AM056ANHPKH×4	18HP	AM056ANHPKH×4 + AM071ANHPKH×4
10HP	AM071ANHPKH×4	20HP	AM071ANHPKH×8
12HP	AM056ANHPKH×6	22HP	AM071ANHPKH×4 + AM090ANHPKH×4
14HP	AM056ANHPKH×1 + AM071ANHPKH×5	24HP	AM071ANHPKH×1 + AM090ANLDKH×7
16HP	AM056ANHPKH×2 + AM090ANHPKH×4	26HP	AM090ANLDKH×6 + AM112ANLDKH×2

* Non-ducted

Capacity	Indoor Units	Capacity	Indoor Units
8HP	AM028ANPKH + AM056ANPKH×2 + AM090ANPKH	18HP	AM028ANPKH + AM056ANPKH + AM056ANPKH + AM056ANPKH×2 + AM090ANPKH×2 + AM128ANPKH
10HP	AM056ANPKH×2 + AM090ANPKH×2	20HP	AM028ANPKH + AM056ANPKH×2 + AM090ANPKH×2 + AM128ANPKH
12HP	AM028ANPKH×2 + AM056ANPKH×2 + AM090ANPKH×2	22HP	AM028ANPKH + AM056ANPKH + AM056ANPKH + AM071ANPKH + AM090ANPKH + AM128ANPKH
14HP	AM028ANPKH + AM056ANPKH + AM056ANPKH + AM071ANPKH + AM090ANPKH + AM128ANPKH	24HP	AM071ANPKH + AM128ANPKH×2 + AM128ANPKH×3
16HP	AM028ANPKH + AM056ANPKH + AM090ANPKH×3 + AM128ANPKH	26HP	AM071ANPKH + AM128ANPKH + AM128ANPKH×4

2. Specification

Standard

Model Name				AM920AXVAGH1EU	AM940AXVAGH1EU	AM960AXVAGH1EU	
			Outdoor unit module 1		AM200AXVAGH/EU	AM220AXVAGH/EU	AM240AXVAGH/EU
			Outdoor unit module 2		AM240AXVAGH/EU	AM240AXVAGH/EU	AM240AXVAGH/EU
			Outdoor unit module 3		AM240AXVAGH/EU	AM240AXVAGH/EU	AM240AXVAGH/EU
			Outdoor unit module 4		AM240AXVAGH/EU	AM240AXVAGH/EU	AM240AXVAGH/EU
Power Supply			Ø, #, V, Hz	3, 4, 380-415, 50	3, 4, 380-415, 50	3, 4, 380-415, 50	
Mode			-	HEAT PUMP	HEAT PUMP	HEAT PUMP	
Performance	HP		HP	92	94	96	
	Capacity	Cooling(Rated)	kW	257.6	263.2	268.8	
		Heating(Rated)	kW	257.6	263.2	268.8	
		Heating(Max)	kW	289.8	296.1	302.4	
Maximum number of connectable indoor units			EA	64	64	64	
Total capacity of the connected Indoor Units		Min.	kW	128.8	131.6	134.4	
		Max.	kW	334.9	342.2	349.4	
Current	Current Input (Ducted)	Cooling(Rated)	A	190.02	195.58	200.20	
		Heating(Rated)	A	163.23	164.85	182.32	
	Current Input (Non-Ducted)	Cooling(Rated)	A	183.84	186.54	195.40	
		Heating(Rated)	A	162.69	164.10	182.32	
	Current	Minimum Ssc	MVA	34.9	35.3	37.2	
		MCA	A	208.0	211.0	220.0	
		MFA	A	250	250	250	
Efficiency	SEER	Ducted	W/W	-	-	-	
	SCOP		W/W	-	-	-	
	ηs.c		%	-	-	-	
	ηs.h	%	-	-	-		
	SEER	Non_Ducted	W/W	-	-	-	
	SCOP		W/W	-	-	-	
	ηs.c		%	-	-	-	
	ηs.h		%	-	-	-	
	Pdesignh		kW	122.1	123.1	124	
Casing	Material	Body	-	GI Steel Plate	GI Steel Plate	GI Steel Plate	
		Base	-	GI Steel Plate	GI Steel Plate	GI Steel Plate	
Heat Exchanger	Type		-	Fin & Tube	Fin & Tube	Fin & Tube	
	Material	Fin	-	Al	Al	Al	
		Tube	-	Cu	Cu	Cu	
	Fin Treatment		-	Anti-corrosion	Anti-corrosion	Anti-corrosion	
Compressor	Type		-	Inverter Scroll x 7	Inverter Scroll x 8	Inverter Scroll x 8	
	Output		kW x n	(8.93 x 1) x 1 + (6.67 x 2) x 3	(6.67 x 2) x 4	(6.67 x 2) x 4	
	Model Name		-	(DS4GM7090FV* x 1) x 1 + (DS4GR7066FV* x 2) x 3	(DS4GR7066FV* x 2) x 4	(DS4GR7066FV* x 2) x 4	
	Oil	Type		-	PVE	PVE	PVE
		Initial charge		cc x n	(1,400 x 1) x 1 + (1,100 x 2) x 3	(1,100 x 2) x 4	(1,100 x 2) x 4
Fan	Type		-	Propeller	Propeller	Propeller	
	Discharge direction		-	Top	Top	Top	
	Quantity		EA	8	8	8	
	Air Flow Rate		m³/min	313 x 1 + 365 x 3	342 x 1 + 365 x 3	365 x 4	
			l/s	5,209 x 1 + 6,089 x 3	5,698 x 1 + 6,089 x 3	6,089 x 4	
	External Static Pressure	Max.	mmAq	11	11	8	
Pa			110	110	80		
Fan Motor	Type		-	BLDC Motor	BLDC Motor	BLDC Motor	
	Output		W x n	(620 x 2) x 4	(620 x 2) x 4	(620 x 2) x 4	
Piping Connections	Liquid Pipe	Type		Braze connection	Braze connection	Braze connection	
		Φ, mm (inch)		25.40 (1)	25.40 (1)	25.40 (1)	
	Gas Pipe	Type		Braze connection	Braze connection	Braze connection	
		Φ, mm (inch)		53.98 (2-1/8)	53.98 (2-1/8)	53.98 (2-1/8)	
	Heat Insulation		-	Both liquid and gas pipes	Both liquid and gas pipes	Both liquid and gas pipes	

2. Specification

Standard

Model Name				AM920AXVAGH1EU	AM940AXVAGH1EU	AM960AXVAGH1EU
	Outdoor unit module 1			AM200AXVAGH/EU	AM220AXVAGH/EU	AM240AXVAGH/EU
	Outdoor unit module 2			AM240AXVAGH/EU	AM240AXVAGH/EU	AM240AXVAGH/EU
	Outdoor unit module 3			AM240AXVAGH/EU	AM240AXVAGH/EU	AM240AXVAGH/EU
	Outdoor unit module 4			AM240AXVAGH/EU	AM240AXVAGH/EU	AM240AXVAGH/EU
Piping Connections	Piping length (ODU-IDU)	Max. [Equiv.]	m	200[220]	200[220]	200[220]
	Piping length (1st Branch-IDU)	Max.	m	90	90	90
	Total piping length (System)	Max.	m	1,000	1,000	1,000
	Level difference (ODU in highest position)	Max.	m	110	110	110
	Level difference (IDU in highest position)	Max.	m	110	110	110
	Level difference (IDU-IDU)	Max.	m	50	50	50
Wiring connections	Transmission Cable	Min.	mm ²	0.75	0.75	0.75
		Remark	-	F1, F2	F1, F2	F1, F2
	Power supply intake		-	Both indoor and outdoor unit	Both indoor and outdoor unit	Both indoor and outdoor unit
Refrigerant	Type		-	R410A	R410A	R410A
	Factory Charging		kg	10.5 x 1 + 14.0 x 3	10.5 x 1 + 14.0 x 3	14.0 x 4
			tCO ₂ e	109.62	109.62	116.93
Sound	Sound Pressure	Cooling	dB(A)	70	71	71
		Heating	dB(A)	72	73	73
	Sound Power		dB(A)	92	93	93
External Dimension	Net Weight		kg	268 x 1 + 325 x 3	301 x 1 + 325 x 3	325 x 4
	Shipping Weight		kg	285 x 1 + 342 x 3	318 x 1 + 342 x 3	342 x 4
	Net Dimensions (WxHxD)		mm	(1,295 x 1,695 x 765) x 4	(1,295 x 1,695 x 765) x 4	(1,295 x 1,695 x 765) x 4
	Shipping Dimensions (WxHxD)		mm	(1,363 x 1,887 x 829) x 4	(1,363 x 1,887 x 829) x 4	(1,363 x 1,887 x 829) x 4
Operating Temp. Range	Cooling		°C	-5 ~ 50	-5 ~ 50	-5 ~ 50
	Heating		°C	-25 ~ 24	-25 ~ 24	-25 ~ 24

NOTE

- Specification may be subject to change without prior notice.
- Specification comply with EN14825 and Eurovent test condition
- 1) Performances are based on the following test conditions.
 - Cooling : Indoor temperature 27°CDB, 19°CWB, Outdoor temperature 35°CDB, 24°CWB
 - Heating : Indoor temperature 20°CDB, 15°CWB, Outdoor temperature 7°CDB, 6°CWB
 - Equivalent refrigerant pipe length 5m, Level differences 0m
 - Refer to EUROVENT website(www.eurovent-certification.com) for other indoor unit combination and more detail test conditions.
- 2) Performance of Multiple Module Outdoor unit is weighted average of Single Module outdoor units.
- 3) Allowed combination ratio of the total rated indoor unit capacity over the rated outdoor unit capacity is 50~130%.
- 4) Sound pressure level is obtained in an anechoic room.
 - Sound pressure level is a relative value, depending on the distance and acoustic environment.
 - Sound pressure level may differ depending on operation condition.
 - dBA = A-weighted sound pressure level
 - Reference acoustic pressure 0 dB = 20uPa
- 5) Sound power level is an absolute value that a sound source generates.
 - dBA = A-weighted sound power level
 - Reference power : 1pW
 - Measured according to ISO 3741
- 6) Sound values of multi combination are theoretical values based on sound results of individual installed units.
- 7) These products contain R410A (GWP=2,088) which is fluorinated greenhouse gas.
- 8) If outdoor unit is located in a higher position than indoor unit, level difference is 110m or under.
 - (If the level difference is higher than 50m, make a decision by PDM kit installation Guide software whether the PDM kit should be installed or not.)
 - PDM kit: Pressure Drop Modulation kit
 - When the outdoor unit is below the indoor unit & the level differences are 40m or more, contact your local dealer for more information.
- 9) In case you want to know more information regarding capacity and correction, please refer to capacity table TDB on pvi.samsung.com site.
- 10) Recommended combination

* Ducted

Capacity	Indoor Units	Capacity	Indoor Units
8HP	AM056ANHPKH×4	18HP	AM056ANHPKH×4 + AM071ANHPKH×4
10HP	AM071ANHPKH×4	20HP	AM071ANHPKH×8
12HP	AM056ANHPKH×6	22HP	AM071ANHPKH×4 + AM090ANHPKH×4
14HP	AM056ANHPKH×1 + AM071ANHPKH×5	24HP	AM071ANHPKH×1 + AM090ANLDKH×7
16HP	AM056ANHPKH×2 + AM090ANHPKH×4	26HP	AM090ANLDKH×6 + AM112ANLDKH×2

* Non-ducted

Capacity	Indoor Units	Capacity	Indoor Units
8HP	AM028ANPKH + AM056ANPKH×2 + AM090ANPKH	18HP	AM028ANPKH + AM056ANPKH + AM056ANPKH + AM056ANPKH×2 + AM090ANPKH×2 + AM071ANPKH
10HP	AM056ANPKH×2 + AM090ANPKH×2	20HP	AM028ANPKH + AM056ANPKH×2 + AM090ANPKH×2 + AM090ANPKH×2 + AM071ANPKH
12HP	AM028ANPKH×2 + AM056ANPKH×2 + AM090ANPKH×2	22HP	AM028ANPKH + AM056ANPKH + AM056ANPKH + AM071ANPKH + AM090ANPKH + AM128ANPKH
14HP	AM028ANPKH + AM056ANPKH + AM056ANPKH + AM071ANPKH + AM090ANPKH + AM128ANPKH	24HP	AM071ANPKH + AM128ANPKH×2 + AM128ANPKH×3
16HP	AM028ANPKH + AM056ANPKH + AM090ANPKH×3 + AM128ANPKH	26HP	AM071ANPKH + AM128ANPKH + AM128ANPKH×4

2. Specification

Standard

Model Name				AM980AXVAGH1EU	
Outdoor unit module 1				AM260AXVAGH/EU	
Outdoor unit module 2				AM240AXVAGH/EU	
Outdoor unit module 3				AM240AXVAGH/EU	
Outdoor unit module 4				AM240AXVAGH/EU	
Power Supply			Ø, #, V, Hz	3, 4, 380-415, 50	
Mode			-	HEAT PUMP	
Performance	HP	HP		98	
	Capacity	Cooling(Rated)	kW	274.4	
		Heating(Rated)	kW	269.6	
		Heating(Max)	kW	308.7	
Maximum number of connectable indoor units			EA	64	
Total capacity of the connected Indoor Units	Min.	kW		137.2	
	Max.	kW		356.7	
Current	Current Input (Ducted)	Cooling(Rated)	A	208.98	
		Heating(Rated)	A	183.28	
	Current Input (Non-Ducted)	Cooling(Rated)	A	205.38	
		Heating(Rated)	A	183.28	
	Current	Minimum Ssc	MVA	38.1	
		MCA	A	225.0	
MFA		A	250		
Efficiency	SEER	Ducted	W/W	-	
	SCOP		W/W	-	
	ηs.c		%	-	
	ηs.h		%	-	
	SEER	Non_Ducted	W/W	-	
	SCOP		W/W	-	
	ηs.c		%	-	
	ηs.h		%	-	
Pdesignh		kW	125		
Casing	Material	Body	-	GI Steel Plate	
		Base	-	GI Steel Plate	
Heat Exchanger	Type	-		Fin & Tube	
	Material	Fin	-	Al	
		Tube	-	Cu	
Fin Treatment		-		Anti-corrosion	
Compressor	Type		-		Inverter Scroll x 8
	Output		kW x n	(6.67 x 2) x 4	
	Model Name		-		(DS4GR7066FV* x 2) x 4
	Oil	Type	-		PVE
Initial charge		cc x n	(1,100 x 2) x 4		
Fan	Type		-		Propeller
	Discharge direction		-		Top
	Quantity		EA	8	
	Air Flow Rate		m ³ /min	365 x 4	
			l/s	6,089 x 4	
External Static Pressure	Max.	mmAq	8		
		Pa	80		
Fan Motor	Type		-		BLDC Motor
	Output		W x n	(620 x 2) x 4	
Piping Connections	Liquid Pipe		Type	Braze connection	
			Ø, mm (inch)	25.40 (1)	
	Gas Pipe		Type	Braze connection	
			Ø, mm (inch)	53.98 (2-1/8)	
Heat Insulation		-		Both liquid and gas pipes	

2. Specification

Standard

Model Name				AM980AXVAGH1EU
	Outdoor unit module 1			AM260AXVAGH/EU
	Outdoor unit module 2			AM240AXVAGH/EU
	Outdoor unit module 3			AM240AXVAGH/EU
	Outdoor unit module 4			AM240AXVAGH/EU
Piping Connections	Piping length (ODU-IDU)	Max. [Equiv.]	m	200[220]
	Piping length (1st Branch-IDU)	Max.	m	90
	Total piping length (System)	Max.	m	1,000
	Level difference (ODU in highest position)	Max.	m	110
	Level difference (IDU in highest position)	Max.	m	110
	Level difference (IDU-IDU)	Max.	m	50
Wiring connections	Transmission Cable	Min.	mm ²	0.75
		Remark	-	F1, F2
	Power supply intake		-	Both indoor and outdoor unit
Refrigerant	Type		-	R410A
	Factory Charging		kg	14.0 x 4
			tCO ₂ e	
Sound	Sound Pressure	Cooling	dB(A)	71
		Heating	dB(A)	73
	Sound Power		dB(A)	93
External Dimension	Net Weight		kg	325 x 4
	Shipping Weight		kg	342 x 4
	Net Dimensions (WxHxD)		mm	(1,295 x 1,695 x 765) x 4
	Shipping Dimensions (WxHxD)		mm	(1,363 x 1,887 x 829) x 4
Operating Temp. Range	Cooling		°C	-5 ~ 50
	Heating		°C	-25 ~ 24

NOTE

- Specification may be subject to change without prior notice.
 - Specification comply with EN14825 and Eurovent test condition
- 1) Performances are based on the following test conditions.
 - Cooling : Indoor temperature 27°CDB, 19°CWB, Outdoor temperature 35°CDB, 24°CWB
 - Heating : Indoor temperature 20°CDB, 15°CWB, Outdoor temperature 7°CDB, 6°CWB
 - Equivalent refrigerant pipe length 5m, Level differences 0m
 - Refer to EUROVENT website(www.eurovent-certification.com) for other indoor unit combination and more detail test conditions.
 - 2) Performance of Multiple Module Outdoor unit is weighted average of Single Module outdoor units.
 - 3) Allowed combination ratio of the total rated indoor unit capacity over the rated outdoor unit capacity is 50~130%.
 - 4) Sound pressure level is obtained in an anechoic room.
 - Sound pressure level is a relative value, depending on the distance and acoustic environment.
 - Sound pressure level may differ depending on operation condition.
 - dBA = A-weighted sound pressure level
 - Reference acoustic pressure 0 dB = 20uPa
 - 5) Sound power level is an absolute value that a sound source generates.
 - dBA = A-weighted sound power level
 - Reference power : 1pW
 - Measured according to ISO 3741
 - 6) Sound values of multi combination are theoretical values based on sound results of individual installed units.
 - 7) These products contain R410A (GWP=2,088) which is fluorinated greenhouse gas.
 - 8) If outdoor unit is located in a higher position than indoor unit, level difference is 110m or under.
 - (If the level difference is higher than 50m, make a decision by PDM kit installation Guide software whether the PDM kit should be installed or not.)
 - PDM kit: Pressure Drop Modulation kit
 - When the outdoor unit is below the indoor unit & the level differences are 40m or more, contact your local dealer for more information.
 - 9) In case you want to know more information regarding capacity and correction, please refer to capacity table TDB on pvi.samsung.com site.
 - 10) Recommended combination

* Ducted

Capacity	Indoor Units	Capacity	Indoor Units
8HP	AM056ANHPKH×4	18HP	AM056ANHPKH×4 + AM071ANHPKH×4
10HP	AM071ANHPKH×4	20HP	AM071ANHPKH×8
12HP	AM056ANHPKH×6	22HP	AM071ANHPKH×4 + AM090ANHPKH×4
14HP	AM056ANHPKH×1 + AM071ANHPKH×5	24HP	AM071ANHPKH×1 + AM090ANLDKH×7
16HP	AM056ANHPKH×2 + AM090ANHPKH×4	26HP	AM090ANLDKH×6 + AM112ANLDKH×2

* Non-ducted

Capacity	Indoor Units	Capacity	Indoor Units
8HP	AM028AN4PKH + AM056AN4PKH×2 + AM090AN4PKH	18HP	AM028AN4PKH + AM056AN4PKH + AM056AN4PKH + AM056AN4PKH×2 + AM090AN4PKH×2 + AM071AN4PKH
10HP	AM056AN4PKH×2 + AM090AN4PKH×2	20HP	AM028AN4PKH + AM056AN4PKH×2 + AM090AN4PKH×2 + AM071AN4PKH
12HP	AM028AN4PKH×2 + AM056AN4PKH×2 + AM090AN4PKH×2	22HP	AM028AN4PKH + AM056AN4PKH + AM056AN4PKH + AM071AN4PKH + AM090AN4PKH + AM128AN4PKH
14HP	AM028AN4PKH + AM056AN4PKH + AM056AN4PKH + AM071AN4PKH + AM090AN4PKH + AM128AN4PKH	24HP	AM071AN4PKH + AM112AN4PKH×2 + AM128AN4PKH×3
16HP	AM028AN4PKH + AM056AN4PKH + AM090AN4PKH×3 + AM128AN4PKH	26HP	AM071AN4PKH + AM112AN4PKH + AM128AN4PKH×4

3. Electric Characteristics

Premium energy efficiency

Capacity		Model Name	Power Supply		Voltage Range		Running Current [A]		Current [A]		ODU Fan Motor	
HP	kW		Hz	Voltage	Min. (-10%)	Max. (+10%)	Cooling	Heating	MCA	MFA	kW	FLA [A]
8	22.4	AM080AXVGGH/EU	50	380-415	342	456	11.44	9.09	18.0	25	0.63	7.3
10	28.0	AM100AXVGGH/EU	50	380-415	342	456	15.97	11.41	21.2	32	0.63	7.3
12	33.6	AM120AXVGGH/EU	50	380-415	342	456	19.25	14.37	25.0	32	0.63	7.3
14	40.0	AM140AXVGGH/EU	50	380-415	342	456	25.44	17.06	27.0	32	1.24	14.6
16	45.0	AM160AXVGGH/EU	50	380-415	342	456	26.96	19.35	32.0	40	1.24	14.6
18	50.4	AM180AXVGGH/EU	50	380-415	342	456	26.79	21.14	39.2	50	1.24	14.6
20	56.0	AM200AXVGGH/EU	50	380-415	342	456	38.63	25.72	43.0	63	1.24	14.6
22	61.6	AM220AXVGGH/EU	50	380-415	342	456	44.15	27.29	46.0	63	1.24	14.6
24	67.2	AM240AXVGGH/EU	50	380-415	342	456	48.62	44.20	55.0	63	1.24	14.6
26	72.8	AM260AXVGGH/EU	50	380-415	342	456	57.61	45.11	60.0	75	1.24	14.6
28	78.4	AM280AXVGGH1EU	50	380-415	342	456	42.76	32.55	60.4	75	1.87	21.9
30	84.0	AM300AXVGGH1EU	50	380-415	342	456	46.04	35.51	64.2	75	1.87	21.9
32	89.6	AM320AXVGGH1EU	50	380-415	342	456	57.88	40.09	68.0	75	1.87	21.9
34	95.4	AM340AXVGGH1EU	50	380-415	342	456	53.75	40.49	71.2	80	2.48	29.2
36	100.8	AM360AXVGGH1EU	50	380-415	342	456	53.58	42.28	78.4	90	2.48	29.2
38	106.4	AM380AXVGGH1EU	50	380-415	342	456	65.42	46.86	82.2	90	2.48	29.2
40	112.0	AM400AXVGGH1EU	50	380-415	342	456	77.26	51.44	86.0	100	2.48	29.2
42	117.6	AM420AXVGGH1EU	50	380-415	342	456	82.78	53.01	89.0	100	2.48	29.2
44	123.2	AM440AXVGGH1EU	50	380-415	342	456	84.40	66.25	99.2	125	2.48	29.2
46	128.8	AM460AXVGGH1EU	50	380-415	342	456	96.24	70.83	103.0	125	2.48	29.2
48	134.4	AM480AXVGGH1EU	50	380-415	342	456	101.76	72.40	106.0	125	2.48	29.2
50	140.0	AM500AXVGGH1EU	50	380-415	342	456	106.23	89.31	115.0	150	2.48	29.2
52	145.6	AM520AXVGGH1EU	50	380-415	342	456	115.22	90.22	120.0	150	2.48	29.2
54	151.2	AM540AXVGGH1EU	50	380-415	342	456	100.37	77.66	120.4	150	3.11	36.5
56	156.8	AM560AXVGGH1EU	50	380-415	342	456	103.65	80.62	124.2	150	3.11	36.5
58	162.4	AM580AXVGGH1EU	50	380-415	342	456	115.49	85.20	128.0	150	3.11	36.5
60	168.0	AM600AXVGGH1EU	50	380-415	342	456	121.01	86.77	131.0	150	3.11	36.5
62	173.6	AM620AXVGGH1EU	50	380-415	342	456	131.19	101.63	141.2	175	3.11	36.5
64	179.2	AM640AXVGGH1EU	50	380-415	342	456	134.47	104.59	145.0	175	3.11	36.5
66	184.8	AM660AXVGGH1EU	50	380-415	342	456	134.87	96.55	146.0	175	3.72	43.8
68	190.4	AM680AXVGGH1EU	50	380-415	342	456	140.39	98.12	149.0	175	3.72	43.8
70	196.0	AM700AXVGGH1EU	50	380-415	342	456	142.01	111.36	159.2	175	3.72	43.8
72	201.6	AM720AXVGGH1EU	50	380-415	342	456	153.85	115.94	163.0	200	3.72	43.8
74	207.2	AM740AXVGGH1EU	50	380-415	342	456	159.37	117.51	166.0	200	3.72	43.8
76	212.8	AM760AXVGGH1EU	50	380-415	342	456	163.84	134.42	175.0	200	3.72	43.8
78	218.4	AM780AXVGGH1EU	50	380-415	342	456	172.83	135.33	180.0	200	3.72	43.8
80	224.8	AM800AXVGGH1EU	50	380-415	342	456	160.31	113.61	173.0	200	4.96	58.4
82	229.8	AM820AXVGGH1EU	50	380-415	342	456	161.83	115.90	178.0	200	4.96	58.4
84	235.2	AM840AXVGGH1EU	50	380-415	342	456	161.66	117.69	185.2	225	4.96	58.4
86	240.8	AM860AXVGGH1EU	50	380-415	342	456	173.50	122.27	189.0	225	4.96	58.4
88	246.4	AM880AXVGGH1EU	50	380-415	342	456	168.80	132.50	198.4	225	4.96	58.4
90	252.0	AM900AXVGGH1EU	50	380-415	342	456	180.64	137.08	202.2	225	4.96	58.4
92	257.6	AM920AXVGGH1EU	50	380-415	342	456	192.48	141.66	206.0	250	4.96	58.4
94	263.2	AM940AXVGGH1EU	50	380-415	342	456	198.00	143.23	209.0	250	4.96	58.4
96	268.8	AM960AXVGGH1EU	50	380-415	342	456	199.62	156.47	219.2	250	4.96	58.4
98	274.4	AM980AXVGGH1EU	50	380-415	342	456	211.46	161.05	223.0	250	4.96	58.4

NOTE

- MCA : Minimum circuit amperes
- MFA : Maximum fuse amperes
- FLA : Full load amperes

3. Electric Characteristics

Standard

Capacity		Model Name	Power Supply		Voltage Range		Running Current [A]		Current [A]		ODU Fan Motor	
HP	kW		Hz	Voltage	Min. (-10%)	Max. (+10%)	Cooling	Heating	MCA	MFA	kW	FLA [A]
8	22.4	AM080AXVAGH/EU	50	380-415	342	456	12.60	9.50	18.0	25	0.63	7.3
10	28.0	AM100AXVAGH/EU	50	380-415	342	456	18.41	12.90	23.0	32	0.63	7.3
12	33.6	AM120AXVAGH/EU	50	380-415	342	456	19.83	14.82	25.0	32	0.63	7.3
14	40.0	AM140AXVAGH/EU	50	380-415	342	456	27.72	18.81	29.0	32	0.63	7.3
16	45.0	AM160AXVAGH/EU	50	380-415	342	456	29.47	20.13	32.0	40	1.24	14.6
18	50.4	AM180AXVAGH/EU	50	380-415	342	456	33.87	22.29	39.2	50	1.24	14.6
20	56.0	AM200AXVAGH/EU	50	380-415	342	456	39.87	26.49	43.0	63	1.24	14.6
22	61.6	AM220AXVAGH/EU	50	380-415	342	456	45.43	28.11	46.0	63	1.24	14.6
24	67.2	AM240AXVAGH/EU	50	380-415	342	456	50.05	45.58	55.0	63	1.24	14.6
26	72.8	AM260AXVAGH/EU	50	380-415	342	456	58.83	46.54	60.0	75	1.24	14.6
28	78.4	AM280AXVAGH1EU	50	380-415	342	456	52.47	35.99	61.0	75	1.87	21.9
30	84.0	AM300AXVAGH1EU	50	380-415	342	456	53.70	37.11	64.2	75	1.87	21.9
32	89.6	AM320AXVAGH1EU	50	380-415	342	456	62.65	55.08	73.0	80	1.87	21.9
34	95.2	AM340AXVAGH1EU	50	380-415	342	456	68.46	58.48	78.0	90	1.87	21.9
36	100.8	AM360AXVAGH1EU	50	380-415	342	456	69.88	60.40	80.0	90	1.87	21.9
38	107.2	AM380AXVAGH1EU	50	380-415	342	456	77.77	64.39	84.0	100	1.87	21.9
40	112.2	AM400AXVAGH1EU	50	380-415	342	456	79.52	65.71	87.0	100	2.48	29.2
42	117.6	AM420AXVAGH1EU	50	380-415	342	456	83.92	67.87	94.2	125	2.48	29.2
44	123.2	AM440AXVAGH1EU	50	380-415	342	456	89.92	72.07	98.0	125	2.48	29.2
46	128.8	AM460AXVAGH1EU	50	380-415	342	456	95.48	73.69	101.0	125	2.48	29.2
48	134.4	AM480AXVAGH1EU	50	380-415	342	456	100.10	91.16	110.0	125	2.48	29.2
50	140.0	AM500AXVAGH1EU	50	380-415	342	456	108.88	92.12	115.0	150	2.48	29.2
52	145.6	AM520AXVAGH1EU	50	380-415	342	456	117.66	93.08	120.0	150	2.48	29.2
54	151.2	AM540AXVAGH1EU	50	380-415	342	456	103.75	82.69	119.2	150	3.11	36.5
56	156.8	AM560AXVAGH1EU	50	380-415	342	456	112.70	100.66	128.0	150	3.11	36.5
58	162.4	AM580AXVAGH1EU	50	380-415	342	456	118.51	104.06	133.0	150	3.11	36.5
60	168.0	AM600AXVAGH1EU	50	380-415	342	456	119.93	105.98	135.0	150	3.11	36.5
62	174.4	AM620AXVAGH1EU	50	380-415	342	456	127.82	109.97	139.0	175	3.11	36.5
64	179.4	AM640AXVAGH1EU	50	380-415	342	456	129.57	111.29	142.0	175	3.72	43.8
66	184.8	AM660AXVAGH1EU	50	380-415	342	456	133.97	113.45	149.2	175	3.72	43.8
68	190.4	AM680AXVAGH1EU	50	380-415	342	456	139.97	117.65	153.0	175	3.72	43.8
70	196.0	AM700AXVAGH1EU	50	380-415	342	456	145.53	119.27	156.0	175	3.72	43.8
72	201.6	AM720AXVAGH1EU	50	380-415	342	456	150.15	136.74	165.0	200	3.72	43.8
74	207.2	AM740AXVAGH1EU	50	380-415	342	456	158.93	137.70	170.0	200	3.72	43.8
76	212.8	AM760AXVAGH1EU	50	380-415	342	456	167.71	138.66	175.0	200	3.72	43.8
78	218.4	AM780AXVAGH1EU	50	380-415	342	456	176.49	139.62	180.0	200	3.72	43.8
80	224.0	AM800AXVAGH1EU	50	380-415	342	456	162.75	146.24	183.0	225	4.35	51.1
82	229.6	AM820AXVAGH1EU	50	380-415	342	456	168.56	149.64	188.0	225	4.35	51.1
84	235.2	AM840AXVAGH1EU	50	380-415	342	456	169.98	151.56	190.0	225	4.35	51.1
86	241.6	AM860AXVAGH1EU	50	380-415	342	456	177.87	155.55	194.0	225	4.35	51.1
88	246.6	AM880AXVAGH1EU	50	380-415	342	456	179.62	156.87	197.0	225	4.96	58.4
90	252.0	AM900AXVAGH1EU	50	380-415	342	456	184.02	159.03	204.2	225	4.96	58.4
92	257.6	AM920AXVAGH1EU	50	380-415	342	456	190.02	163.23	208.0	250	4.96	58.4
94	263.2	AM940AXVAGH1EU	50	380-415	342	456	195.58	164.85	211.0	250	4.96	58.4
96	268.8	AM960AXVAGH1EU	50	380-415	342	456	200.20	182.32	220.0	250	4.96	58.4
98	274.4	AM980AXVAGH1EU	50	380-415	342	456	208.98	183.28	225.0	250	4.96	58.4

NOTE

- MCA : Minimum circuit amperes
- MFA : Maximum fuse amperes
- FLA : Full load amperes

4. Dimensional Drawing

Outdoor unit

- AM080AXVAGH/EU, AM100AXVAGH/EU

Unit: mm (inches)

SECTION B-B

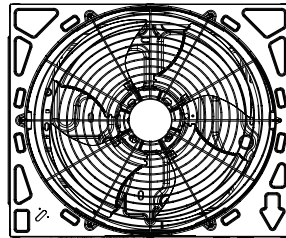
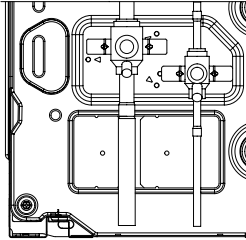

DETAIL A

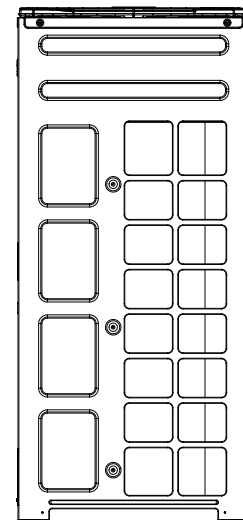
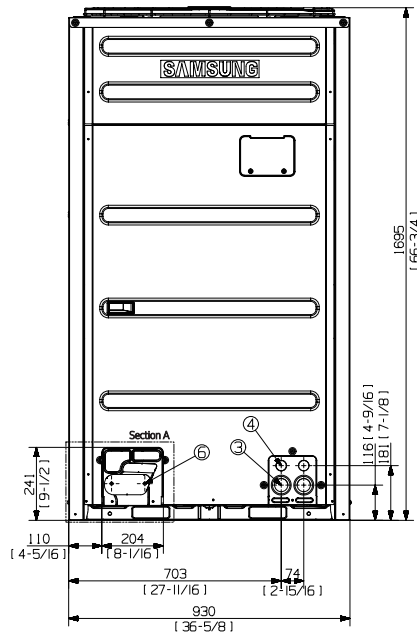
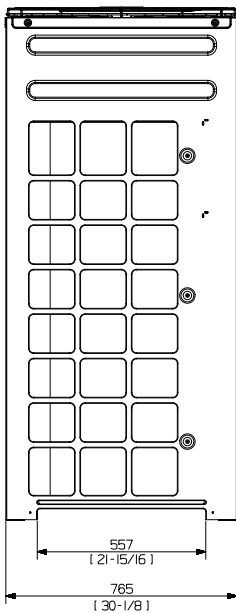
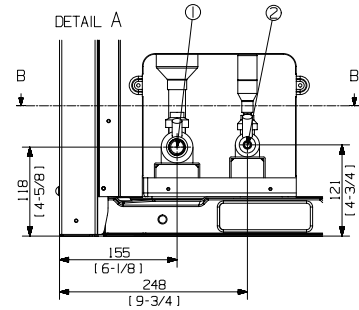

NOTE

- 1 Detail A and SECTION B-B indicate the dimension after fixing the attached piping.
- 2 Item 3-6: Knock-out hole
- 3 View C indicate the dimension of knock-out hole (bottom)
- 4 Pipe [Ø, mm(inch)]: Brazing connection

HP	Liquid pipe	Gas pipe
8	9.52(3/8)	19.05(3/4)
10	9.52(3/8)	22.22(7/8)
12	12.70(1/2)	28.58(1-1/8)
14	12.70(1/2)	28.58(1-1/8)
16	12.70(1/2)	28.58(1-1/8)
18	15.88(5/8)	28.58(1-1/8)
20	15.88(5/8)	28.58(1-1/8)
22	15.88(5/8)	28.58(1-1/8)
24	15.88(5/8)	34.92(1-3/8)
26	19.05(3/4)	34.92(1-3/8)

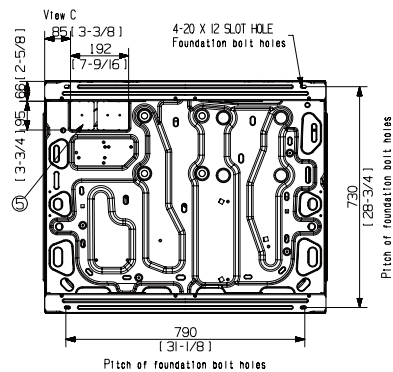

NO	Table of descriptions	Remark	NO	Table of descriptions	Remark
1	Gas Ref.pipe	See NOTE 4.	5	Knock-out Hole for Ref.Piping (bottom)	
2	Liquid Ref.pipe	See NOTE 4.	6	Knock-out Hole for Ref.Piping (front)	
3	Power wiring conduit	Ø44			
4	Communication wiring conduit	Ø34			

4. Dimensional Drawing

Outdoor unit

• AM120/140AXVAGH/EU, AM080/100/120AXVGGH/EU

Unit: mm (inches)

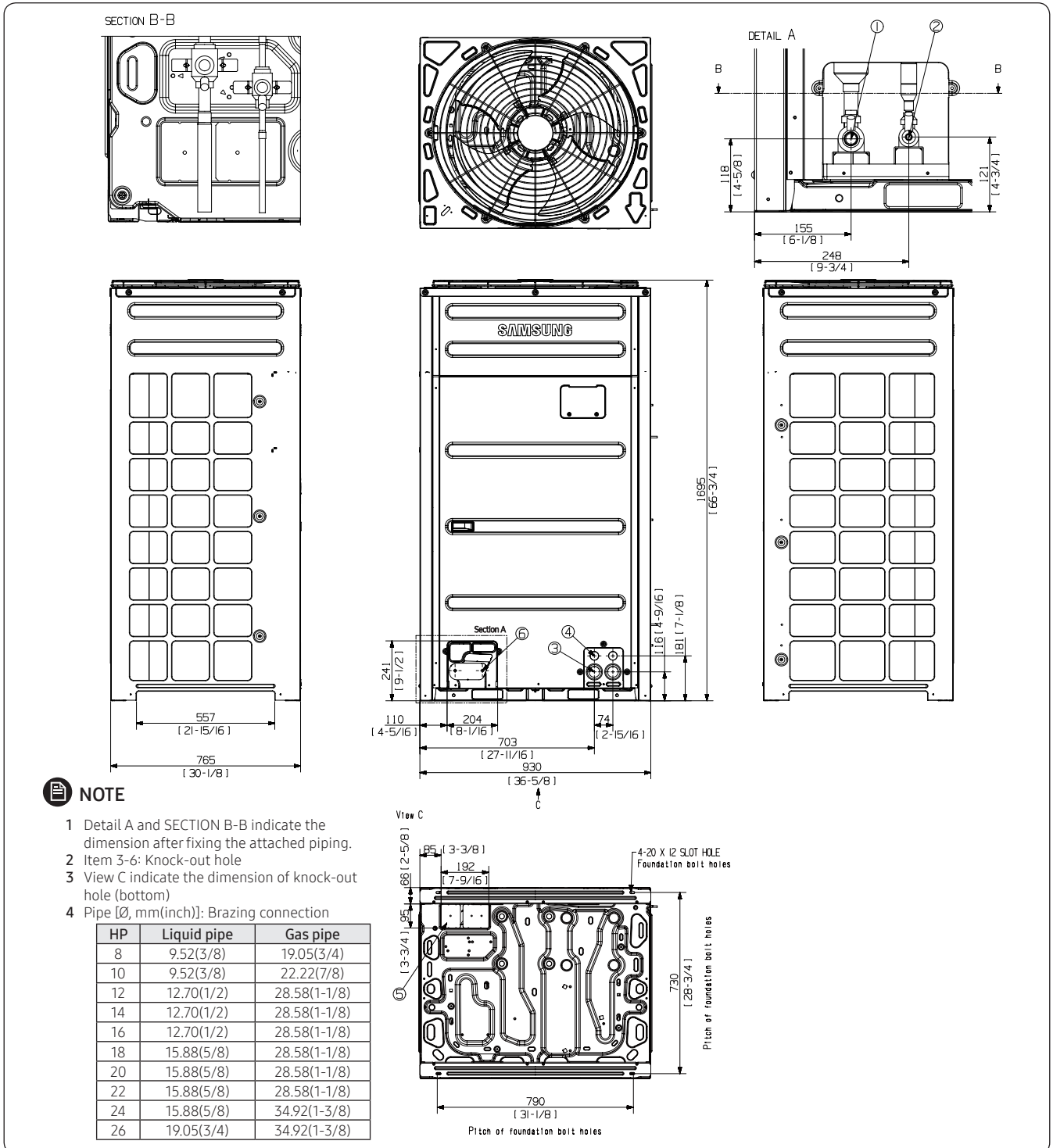

NO	Table of descriptions	Remark	NO	Table of descriptions	Remark
1	Gas Ref.pipe	See NOTE 4.	5	Knock-out Hole for Ref.Piping (bottom)	
2	Liquid Ref.pipe	See NOTE 4.	6	Knock-out Hole for Ref.Piping (front)	
3	Power wiring conduit	Ø44			
4	Communication wiring conduit	Ø34			

4. Dimensional Drawing

Outdoor unit

• AM160/180/200/220/240/260AXVAGH/EU, AM140/160/180/200/220/240/260AXVGGH/EU

Unit: mm (inches)

SECTION B-B

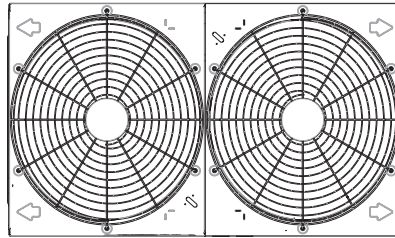
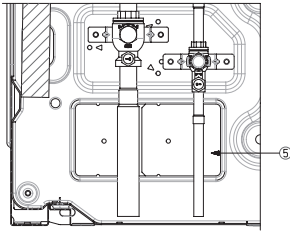

DETAIL A
SCALE 1:2

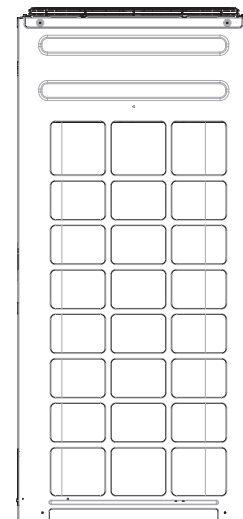
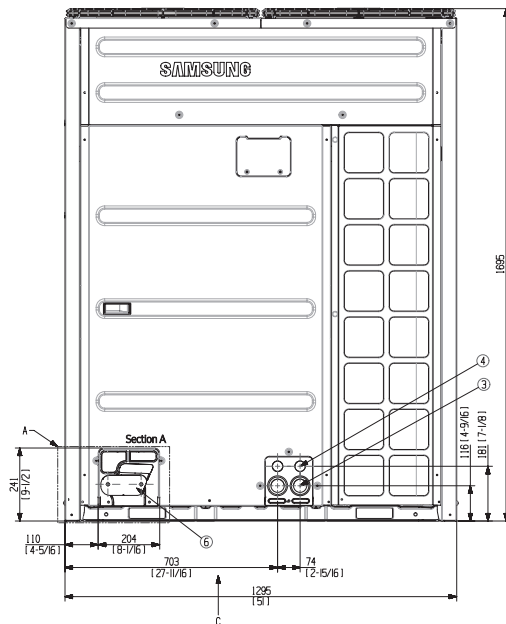
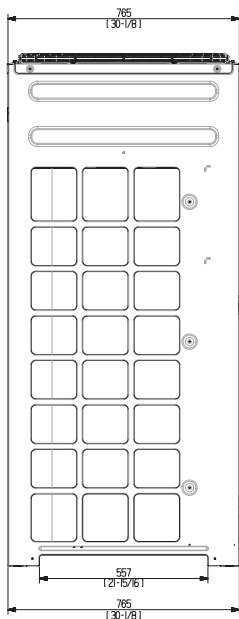
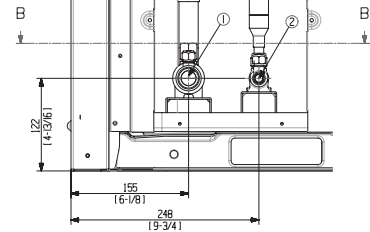

NOTE

- 1 Detail A and SECTION B-B indicate the dimension after fixing the attached piping.
- 2 Item 3-6: Knock-out hole
- 3 View C indicate the dimension of knock-out hole (bottom)
- 4 Pipe \varnothing , mm(inch): Brazing connection

HP	Liquid pipe	Gas pipe
8	9.52(3/8)	19.05(3/4)
10	9.52(3/8)	22.22(7/8)
12	12.70(1/2)	28.58(1-1/8)
14	12.70(1/2)	28.58(1-1/8)
16	12.70(1/2)	28.58(1-1/8)
18	15.88(5/8)	28.58(1-1/8)
20	15.88(5/8)	28.58(1-1/8)
22	15.88(5/8)	28.58(1-1/8)
24	15.88(5/8)	34.92(1-3/8)
26	19.05(3/4)	34.92(1-3/8)

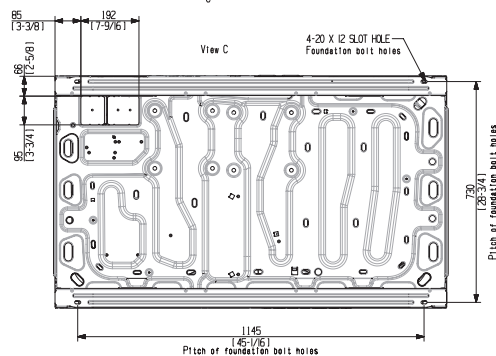

NO	Table of descriptions	Remark	NO	Table of descriptions	Remark
1	Gas Ref.pipe	See NOTE 4.	5	Knock-out Hole for Ref.Piping (bottom)	
2	Liquid Ref.pipe	See NOTE 4.	6	Knock-out Hole for Ref.Piping (front)	
3	Power wiring conduit	\varnothing 44			
4	Communication wiring conduit	\varnothing 34			

5. Center of Gravity

Outdoor unit

Unit: mm (inches)

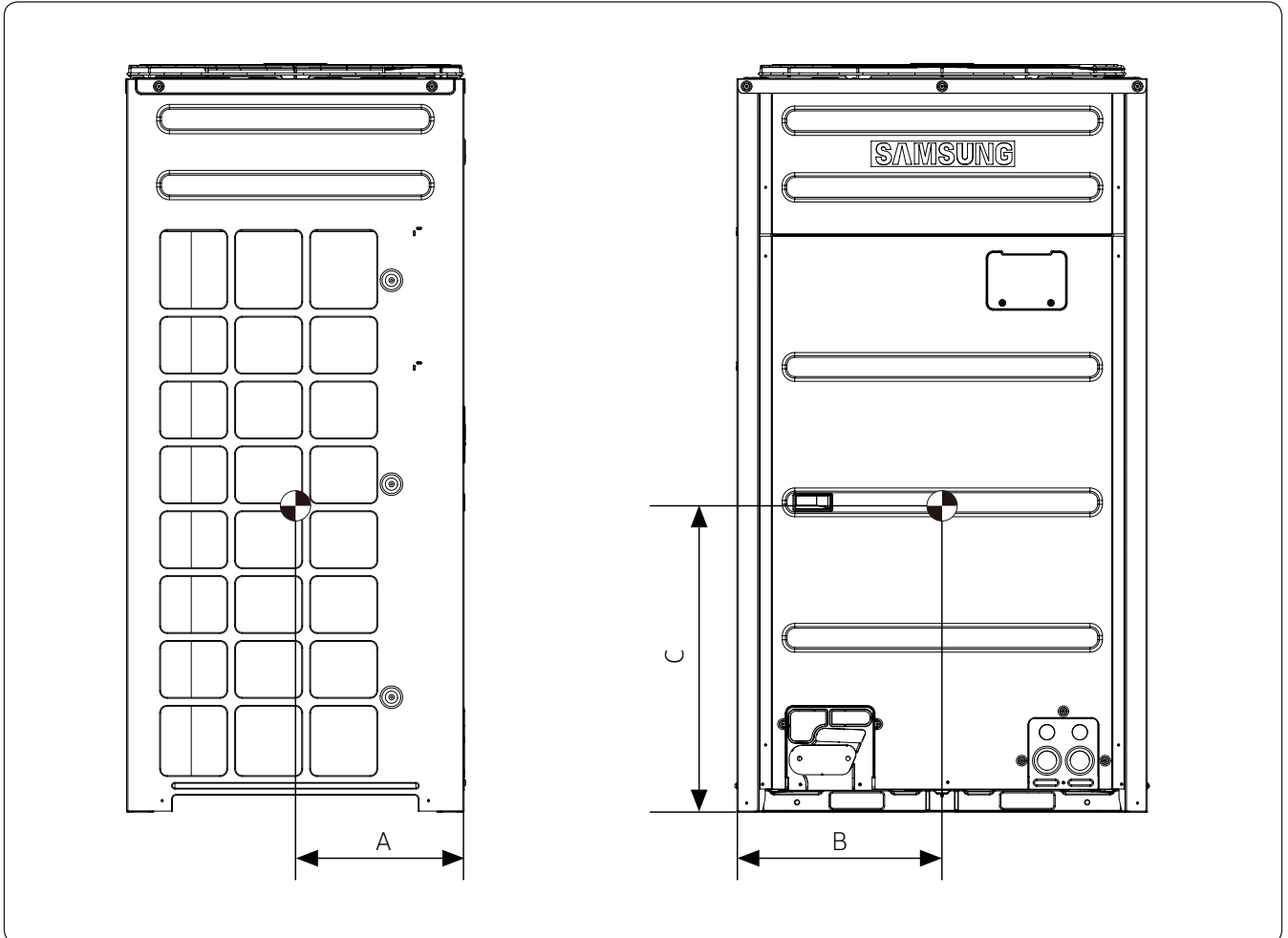

Model	A	B	C
AM080AXVAGH/EU	348[13 - 11/16]	460[18 - 1/8]	716[28 - 3/16]
AM100AXVAGH/EU	340[13 - 3/8]	458[18 - 1/16]	694[27 - 5/16]

5. Center of Gravity

Outdoor unit

Unit: mm (inches)

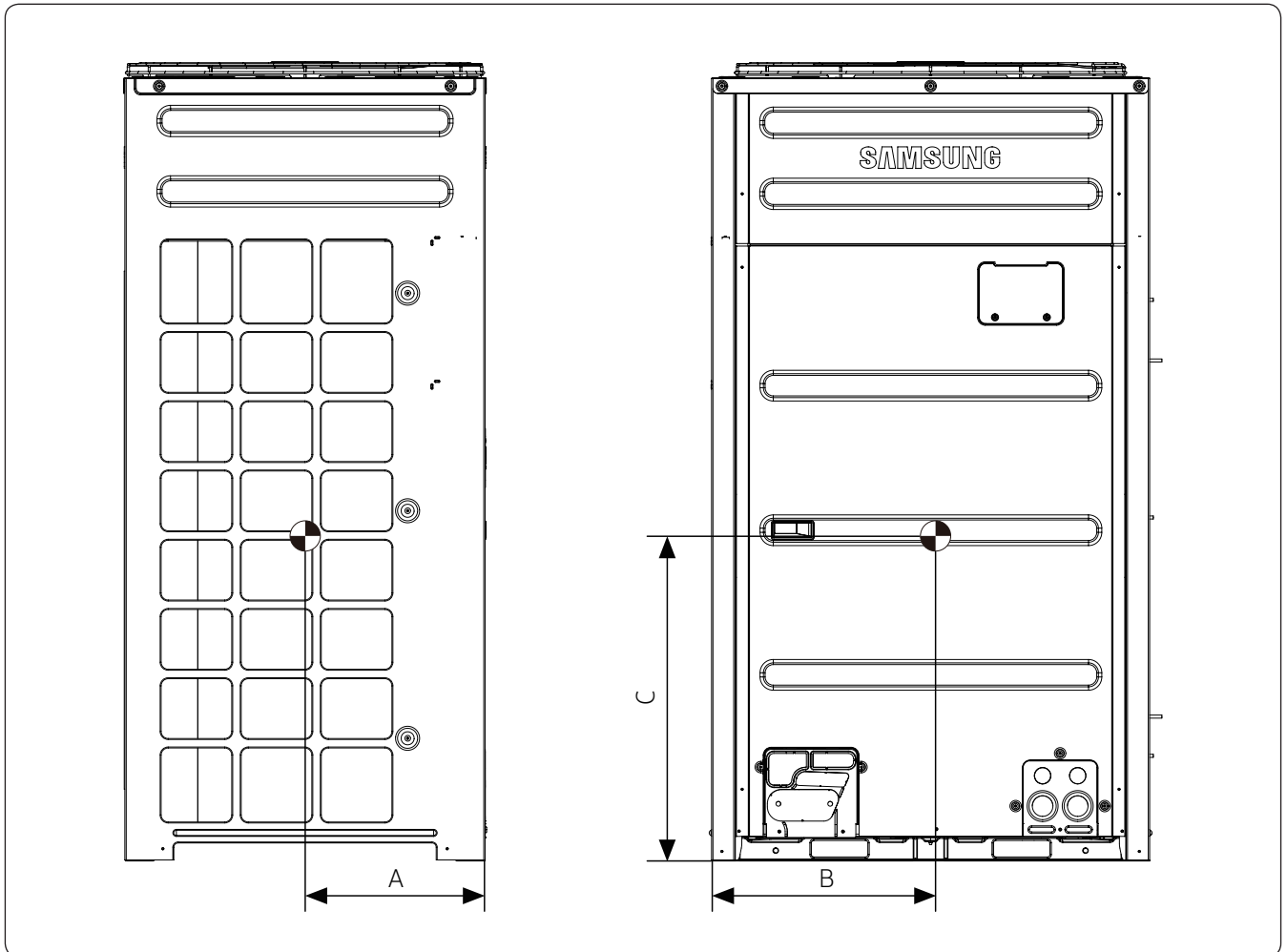

Model	A	B	C
AM080AXVGGH/EU	358 [14 - 1/8]	463 [18 - 1/4]	715 [28 - 1/8]
AM100AXVGGH/EU AM120AXVGGH/EU AM120AXVAGH/EU AM140AXVAGH/EU	351 [13 - 13/16]	461 [18 - 1/8]	694 [27 - 5/16]

5. Center of Gravity

Outdoor unit

Unit: mm (inches)

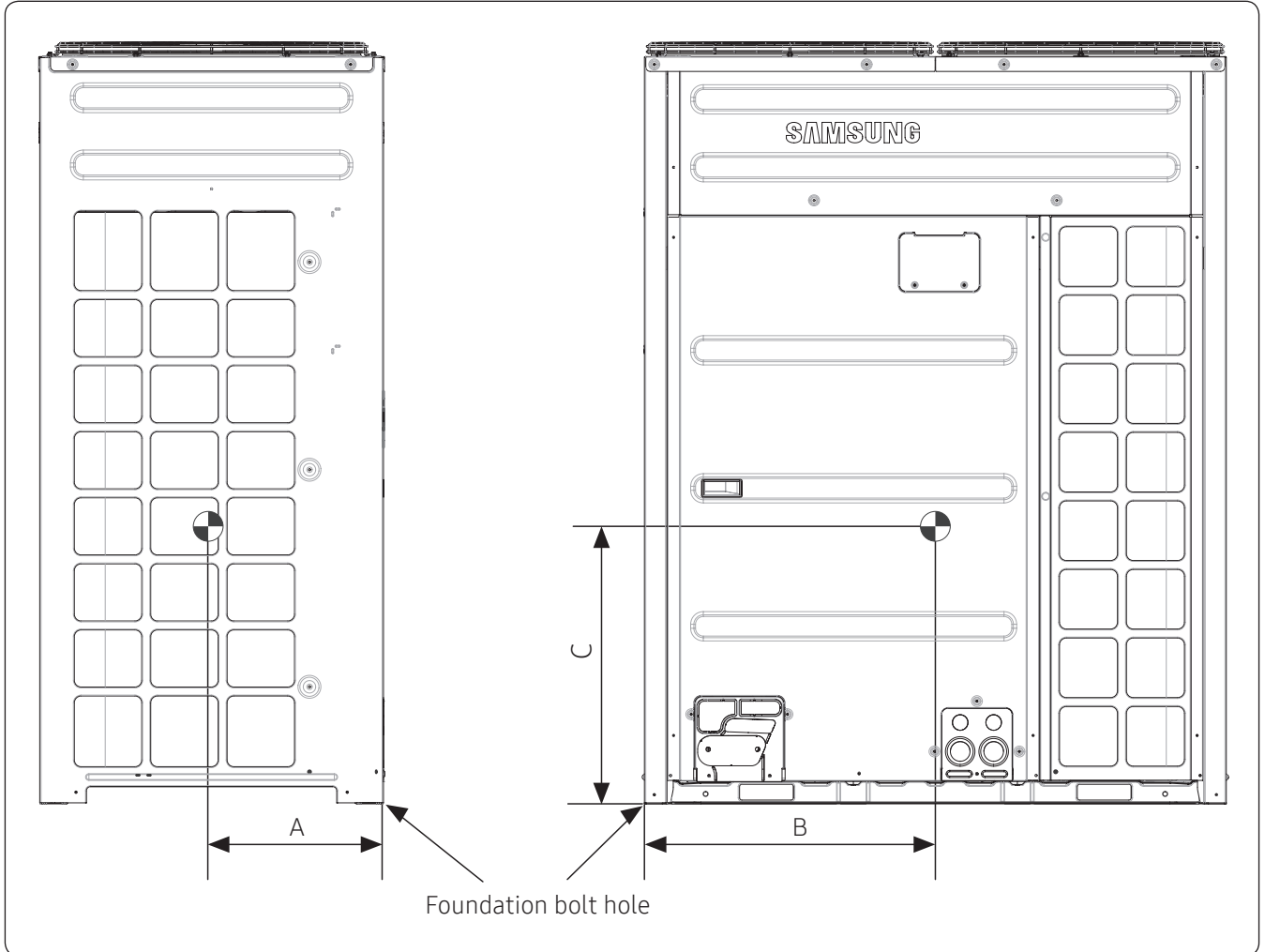

Model	A	B	C
AM140AXVGGH/EU	342[13 - 7/16]	500[19 - 11/16]	731[28 - 3/4]
AM160AXVGGH/EU AM180AXVGGH/EU AM200AXVGGH/EU AM160AXVAGH/EU AM180AXVAGH/EU AM200AXVAGH/EU	345[13 - 9/16]	502[19 - 3/4]	719[28 - 5/16]
AM220AXVGGH/EU AM240AXVGGH/EU AM260AXVGGH/EU AM220AXVAGH/EU AM240AXVAGH/EU AM260AXVAGH/EU	324[12 - 3/4]	520[20 - 1/2]	678[26 - 11/16]

6. Electrical Wiring Diagrams

Outdoor unit

AM080~120AXVAGH/EU, AM080~120AXVGGH/EU

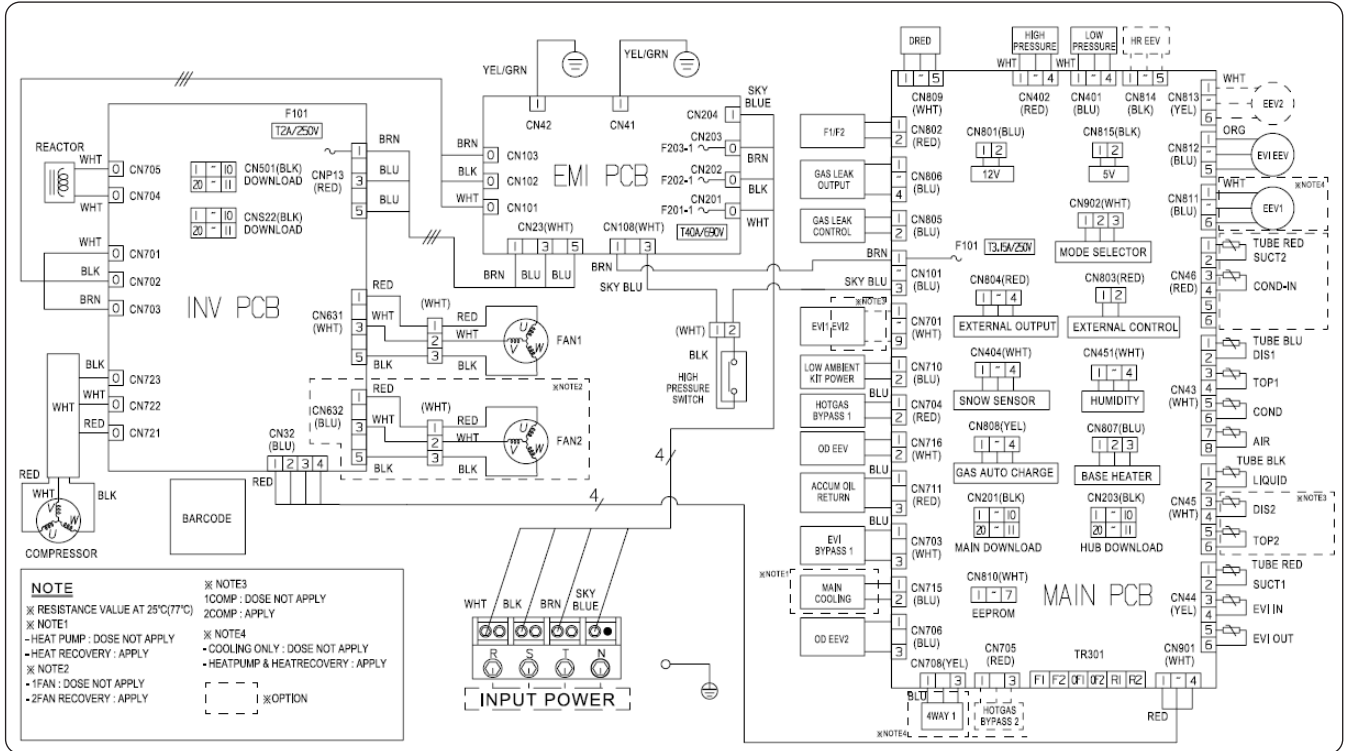

INV PCB	Printed circuit board (inverter)	EVI-OUT(10K)	Thermistor (EVI-out_10kohm)
EMI PCB	Printed circuit board (emi)	EVI-IN(10K)	Thermistor (EVI-in_10kohm)
MAIN PCB	Printed circuit board (main)	SUCT1(10K)	Thermistor (Suction Temp.1_10kohm)
COMPRESSOR	Motor (compressor)	SUCT2(10K)	Thermistor (Suction Temp.2_10kohm)
FAN1	Motor (fan1)	SNOW SENSOR	SNOW SENSOR
EVI V/V1	Solenoid valve (EVI1)	AIR(10K)	Thermistor (Ambient Temp._10kohm)
EVI V/V2	Solenoid valve (EVI2)	COND(10K)	Thermistor (Cond Out Temp._10kohm)
EVI EEV	Electronic expansion valve (EVI)	TOP1(200K)	Thermistor (Compressor Top 1_200kohm)
EEV1	Electronic expansion valve 1	TOP2(200K)	Thermistor (Compressor Top 2_200kohm)
EEV2	Electronic expansion valve 2	DIS1(200K)	Thermistor (Discharge Temp.1_200kohm)
OD EEV V/V	Electronic expansion valve (Outdoor EEV)	DIS2(200K)	Thermistor (Discharge Temp.2_200kohm)
HOTGAS1 BYPASS V/V	Solenoid valve (Hot Gas Bypass1)	LIQUID(10K)	Thermistor (Liquid Tube Temp._10kohm)
EVI BYPASS1 V/V	Solenoid valve (EVI BYPASS)	F101	FUSE (INV PCB)
ACCUM OIL RETURN V/V	Solenoid valve (Accumulator Oil Return)	690V/40A	FUSE (EMI PCB)
4WAY1 V/V	Solenoid valve (4 Way valve)	MODE SELECTOR	Connector (Remote switching cool/heat selector)
MAIN COOLING	Solenoid valve (Main cooling)	EXTERNAL CONTROL	Connector (Output EXTERNAL CONTROL)
HOTGAS2 BYPASS V/V	Solenoid valve (Hot Gas Bypass2)	EXTERNAL OUTPUT	Connector (Output EXTERNAL)

NOTE

- This wiring diagram applies only to the outdoor unit.
- Colors blk: black, red: red, blu: blue, wht: white, yel: yellow, brn: brown, sky: skyblue
- When operating, don't shortcircuit the protection device (High Pressure switch)
- For connection wiring indoor-outdoor transmission F1-F2, outdoor_outdoor transmission OF1-OF2, refer to the installation manual.
- Protective earth(screw), : connector, \overline{N} : The wire quantity

6. Electrical Wiring Diagrams

Outdoor unit

AM140~180AXVAGH/EU, AM140~160AXVGGH/EU

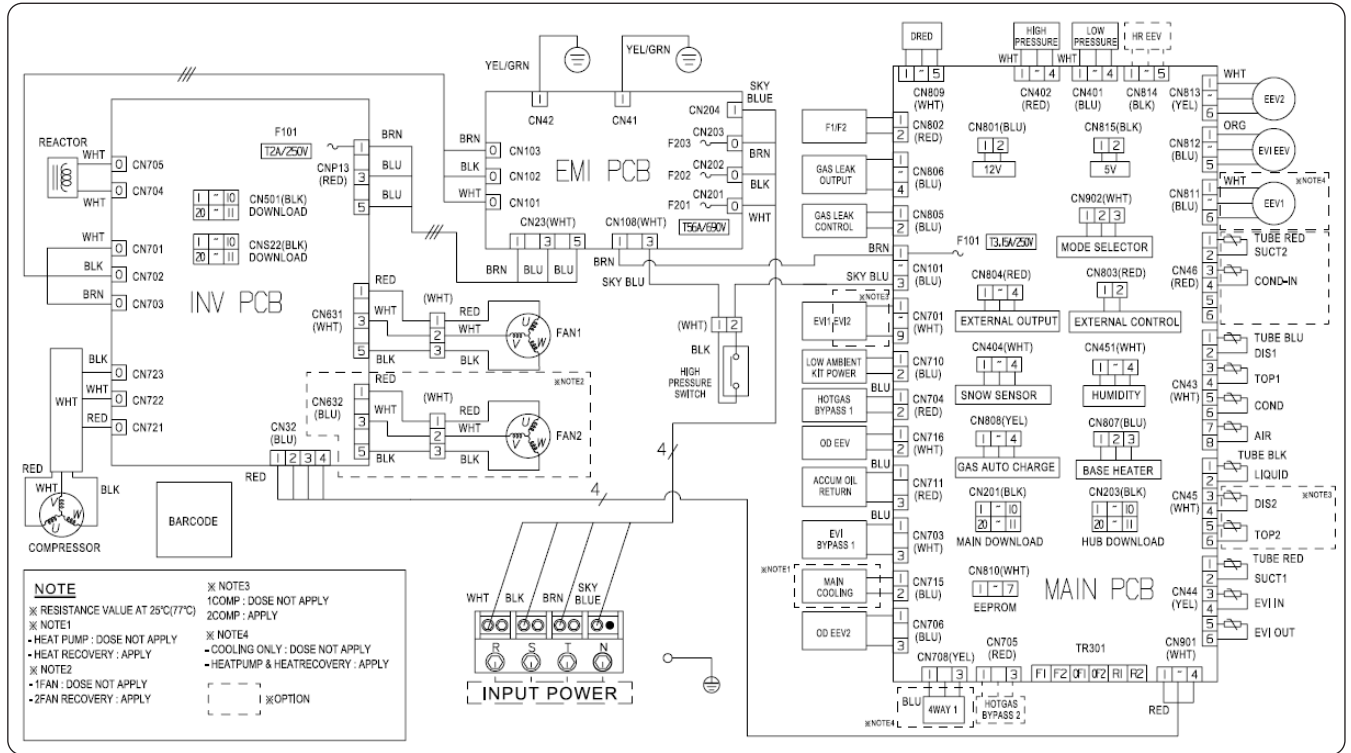

INV PCB	Printed circuit board (inverter)	EVI-OUT(10K)	Thermistor (EVI-out_10kohm)
EMI PCB	Printed circuit board (emi)	EVI-IN(10K)	Thermistor (EVI-in_10kohm)
MAIN PCB	Printed circuit board (main)	SUCT1(10K)	Thermistor (Suction Temp.1_10kohm)
COMPRESSOR	Motor (compressor)	SUCT2(10K)	Thermistor (Suction Temp.2_10kohm)
FAN1	Motor (fan1)	SNOW SENSOR	SNOW SENSOR
FAN2	Motor (fan2)	AIR(10K)	Thermistor (Ambient Temp_10kohm)
EVI V/V1	Solenoid valve (EVI1)	COND(10K)	Thermistor (Cond Out Temp_10kohm)
EVI V/V2	Solenoid valve (EVI2)	TOP1(200K)	Thermistor (Compressor Top 1_200kohm)
EVI EEV	Electronic expansion valve (EVI)	TOP2(200K)	Thermistor (Compressor Top 2_200kohm)
EEV1	Electronic expansion valve 1	DIS1(200K)	Thermistor (Discharge Temp.1_200kohm)
EEV2	Electronic expansion valve 2	DIS2(200K)	Thermistor (Discharge Temp.2_200kohm)
OD EEV V/V	Electronic expansion valve (Outdoor EEV)	LIQUID(10K)	Thermistor (Liquid Tube Temp_10kohm)
HOTGAS1 BYPASS V/V	Solenoid valve (Hot Gas Bypass1)	F101	FUSE (INV PCB)
EVI BYPASS1 V/V	Solenoid valve (EVI BYPASS)	690V/56A	FUSE (EMI PCB)
ACCUM OIL RETURN V/V	Solenoid valve (Accumulator Oil Return)	MODE SELECTOR	Connector (Remote switching cool/heat selector)
4WAY1 V/V	Solenoid valve (4 Way valve)	EXTERNAL CONTROL	Connector (Output EXTERNAL CONTROL)
MAIN COOLING	Solenoid valve (Main cooling)	EXTERNAL OUTPUT	Connector (Output EXTERNAL)
HOTGAS2 BYPASS V/V	Solenoid valve (Hot Gas Bypass2)		

NOTE

- This wiring diagram applies only to the outdoor unit.
- Colors blk: black, red: red, blu: blue, wht: white, yel: yellow, brn: brown, sky: skyblue
- When operating, don't shortcircuit the protection device (High Pressure switch)
- For connection wiring indoor-outdoor transmission F1-F2, outdoor_outdoor transmission OF1-OF2, refer to the installation manual.
- Protective earth(screw), : connector, : The wire quantity

6. Electrical Wiring Diagrams

Outdoor unit

AM200AXVAGH/EU, AM180~200AXVGGH/EU

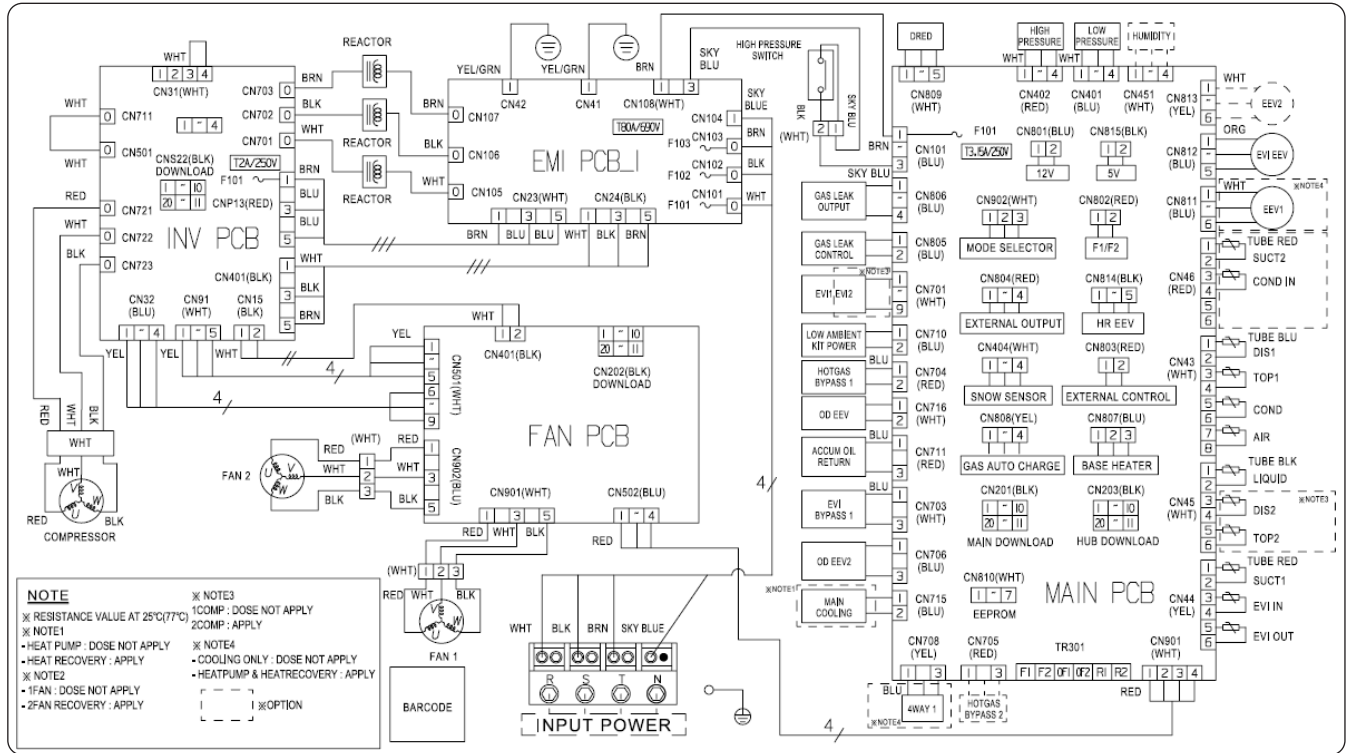

INV PCB	Printed circuit board (inverter)	EVI-OUT(10K)	Thermistor (EVI-out_10kohm)
EMI PCB1	Printed circuit board (emi1)	EVI-IN(10K)	Thermistor (EVI-in_10kohm)
FAN PCB	Printed circuit board (fan motor)	SUCT1(10K)	Thermistor (Suction Temp.1_10Kohm)
MAIN PCB	Printed circuit board (main)	SUCT2(10K)	Thermistor (Suction Temp.2_10Kohm)
COMPRESSOR	Motor (compressor)	SNOW SENSOR	SNOW SENSOR
FAN1	Motor (fan1)	AIR(10K)	Thermistor (Ambient Temp._10Kohm)
FAN2	Motor (fan2)	COND(10K)	Thermistor (Cond Out Temp._10Kohm)
EVI V/V1	Solenode valve (EVI1)	TOP1(200K)	Thermistor (Compressor Top 1_200Kohm)
EVI V/V2	Solenode valve (EVI2)	TOP2(200K)	Thermistor (Compressor Top 2_200Kohm)
EVI EEV	Electronic expansion valve (EVI)	DIS1(200K)	Thermistor (Discharge Temp.1_200Kohm)
EEV1	Electronic expansion valve 1	DIS2(200K)	Thermistor (Discharge Temp.2_200Kohm)
EEV2	Electronic expansion valve 2	LIQUID(10K)	Thermistor (Liquid Tube Temp_10Kohm)
HOTGAS1 BYPASS V/V	Solenoid valve (Hot Gas Bypass1)	OD EEV V/V	Electronic expansion valve (Outdoor EEV)
EVI BYPASS1 V/V	Solenoid valve (EVI BYPASS)	F101	FUSE (INV PCB)
ACCUM OIL RETURN V/V	Solenoid valve (Accumulator Oil Return)	690V/80A	FUSE (EMI PCB)
4WAY1 V/V	Solenoid valve (4 Way valve)	MODE SELECTOR	Connector (Remote switching cool/heat selector)
MAIN COOLING	Solenoid valve (Main cooling)	EXTERNAL CONTROL	Connector (Output EXTERNAL CONTROL)
HOTGAS2 BYPASS V/V	Solenoid valve (Hot Gas Bypass2)	EXTERNAL OUTPUT	Connector (Output EXTERNAL)

NOTE

- This wiring diagram applies only to the outdoor unit.
- Colors blk: black, red: red, blu: blue, wht: white, yel: yellow, brn: brown, sky: skyblue
- When operating, don't shortcircuit the protection device (High Pressure switch)
- For connection wiring indoor-outdoor transmission F1-F2, outdoor_outdoor transmission OF1-OF2, refer to the installation manual.
- Protective earth(screw), : connector, : The wire quantity

6. Electrical Wiring Diagrams

Outdoor unit

AM220AXVAGH/EU, AM220AXVGGH/EU

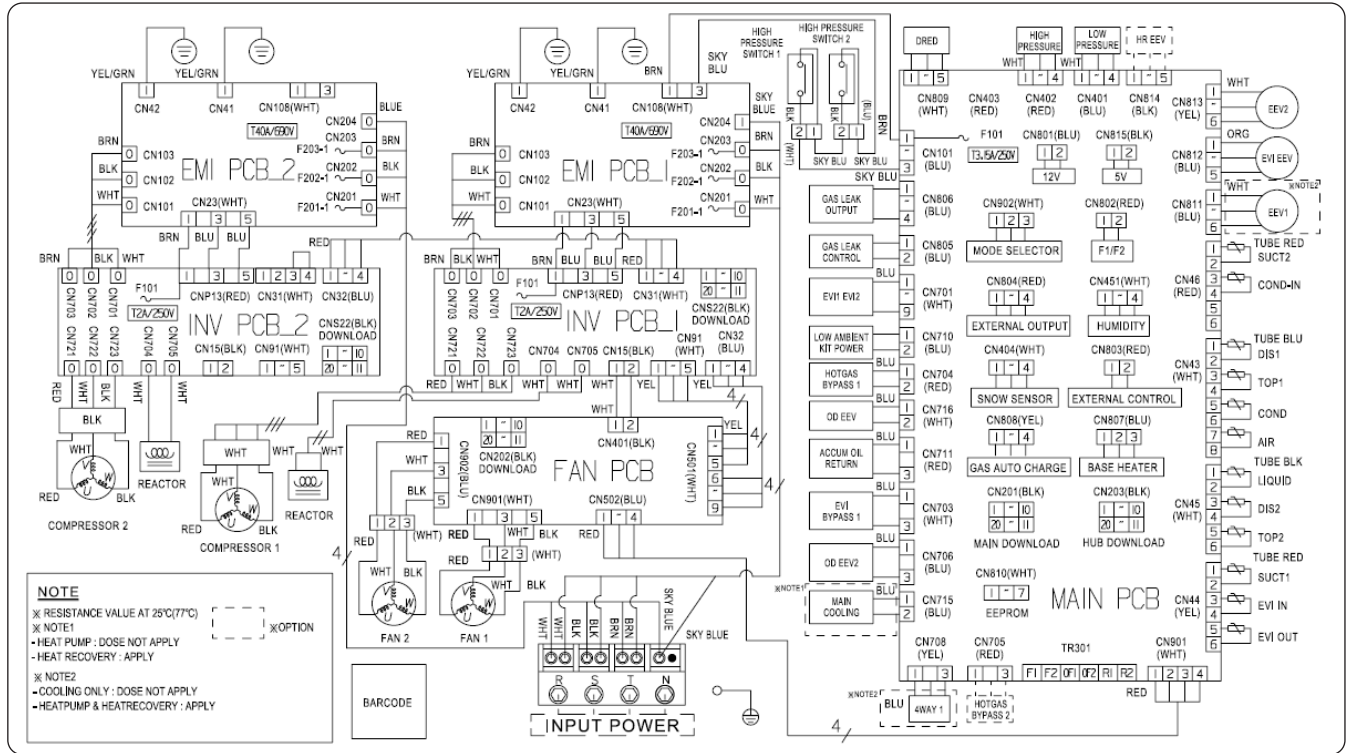

INV PCB1	Printed circuit board (inverter1)	EEV1	Electronic expansion valve 1
INV PCB2	Printed circuit board (inverter2)	EEV2	Electronic expansion valve 2
EMI PCB1	Printed circuit board (emi1)	EVI-OUT(10K)	Thermistor (EVI-out_10kohm)
EMI PCB2	Printed circuit board (emi2)	EVI-IN(10K)	Thermistor (EVI-in_10kohm)
FAN PCB	Printed circuit board (fan motor)	SUCT1(10K)	Thermistor (Suction Temp.1_10Kohm)
MAIN PCB	Printed circuit board (main)	SUCT2(10K)	Thermistor (Suction Temp.2_10Kohm)
COMPRESSOR1	Motor (compressor1)	COND IN(10K)	Thermistor (Cond In Temp_10Kohm)
COMPRESSOR2	Motor (compressor2)	AIR(10K)	Thermistor (Ambient Temp_10Kohm)
FAN1	Motor (fan1)	COND(10K)	Thermistor (Cond Out Temp_10Kohm)
FAN2	Motor (fan2)	TOP1(200K)	Thermistor (Compressor Top 1_200Kohm)
EVI V/V1	Solenoid valve (EVI1)	TOP2(200K)	Thermistor (Compressor Top 2_200Kohm)
EVI V/V2	Solenoid valve (EVI2)	DIS1(200K)	Thermistor (Discharge Temp.1_200Kohm)
EVI EEV	Electronic expansion valve (EVI)	DIS2(200K)	Thermistor (Discharge Temp.2_200Kohm)
SNOW SENSOR	SNOW SENSOR	HOTGAS2 BYPASS V/V	Solenoid valve (Hot Gas Bypass2)
LIQUID(10K)	Thermistor (Liquid Tube Temp_10Kohm)	OD EEV V/V	Electronic expansion valve (Outdoor EEV)
HOTGAS1 BYPASS V/V	Solenoid valve (Hot Gas Bypass1)	F101	FUSE (INV PCB)
EVI BYPASS1 V/V	Solenoid valve (EVI BYPASS)	690V/40A	FUSE (EMI PCB)
ACCUM OIL RETURN V/V	Solenoid valve (Accumulator Oil Return)	MODE SELECTOR	Connector (Remote switching cool/heat selector)
4WAY1 V/V	Solenoid valve (4 Way valve)	EXTERNAL CONTROL	Connector (Output EXTERNAL CONTROL)
MAIN COOLING	Solenoid valve (Main cooling)	EXTERNAL OUTPUT	Connector (Output EXTERNAL)

NOTE

- This wiring diagram applies only to the outdoor unit.
- Colors blk: black, red: red, blu: blue, wht: white, yel: yellow, brn: brown, sky: skyblue
- When operating, don't shortcircuit the protection device (High Pressure switch)
- For connection wiring indoor-outdoor transmission F1-F2, outdoor_outdoor transmission OF1-OF2, refer to the installation manual.
- Protective earth(screw), : connector, : The wire quantity

6. Electrical Wiring Diagrams

Outdoor unit

AM240~260AXVAGH/EU, AM240~260AXVGGH/EU

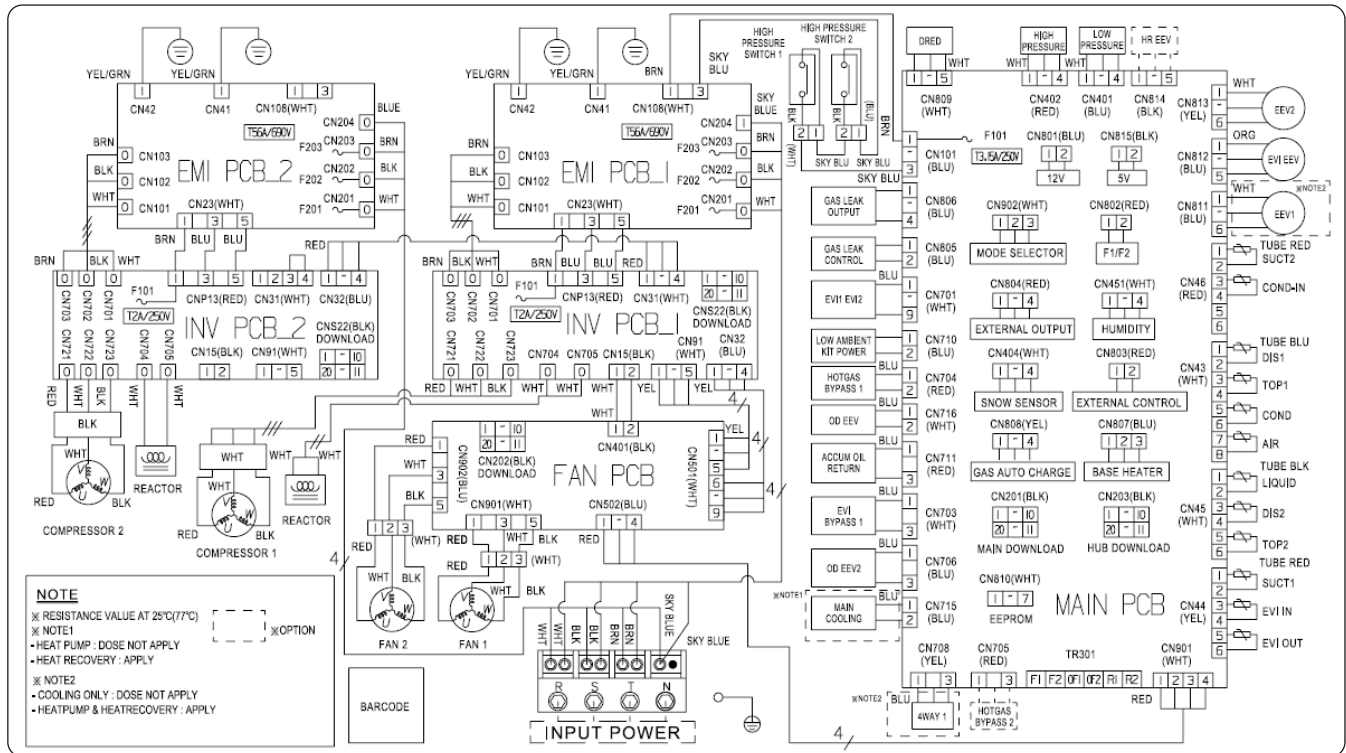

INV PCB1	Printed circuit board (inverter1)	EEV1	Electronic expansion valve 1
INV PCB2	Printed circuit board (inverter2)	EEV2	Electronic expansion valve 2
EMI PCB1	Printed circuit board (emi1)	EVI-OUT(10K)	Thermistor (EVI-out_10kohm)
EMI PCB2	Printed circuit board (emi2)	EVI-IN(10K)	Thermistor (EVI-in_10kohm)
FAN PCB	Printed circuit board (fan motor)	SUCT1(10K)	Thermistor (Suction Temp.1_10Kohm)
MAIN PCB	Printed circuit board (main)	SUCT2(10K)	Thermistor (Suction Temp.2_10Kohm)
COMPRESSOR1	Motor (compressor1)	COND IN(10K)	Thermistor (Cond In Temp_10Kohm)
COMPRESSOR2	Motor (compressor2)	AIR(10K)	Thermistor (Ambient Temp_10Kohm)
FAN1	Motor (fan1)	COND(10K)	Thermistor (Cond Out Temp_10Kohm)
FAN2	Motor (fan2)	TOP1(200K)	Thermistor (Compressor Top 1_200Kohm)
EVI V/V1	Solenoid valve (EVI1)	TOP2(200K)	Thermistor (Compressor Top 2_200Kohm)
EVI V/V2	Solenoid valve (EVI2)	DIS1(200K)	Thermistor (Discharge Temp.1_200Kohm)
EVI EEV	Electronic expansion valve (EVI)	DIS2(200K)	Thermistor (Discharge Temp.2_200Kohm)
SNOW SENSOR	SNOW SENSOR	HOTGAS2 BYPASS V/V	Solenoid valve (Hot Gas Bypass2)
LIQUID(10K)	Thermistor (Liquid Tube Temp_10Kohm)	OD EEV V/V	Electronic expansion valve (Outdoor EEV)
HOTGAS1 BYPASS V/V	Solenoid valve (Hot Gas Bypass1)	F101	FUSE (INV PCB)
EVI BYPASS1 V/V	Solenoid valve (EVI BYPASS)	690V/56A	FUSE (EMI PCB)
ACCUM OIL RETURN V/V	Solenoid valve (Accumulator Oil Return)	MODE SELECTOR	Connector (Remote switching cool/heat selector)
4WAY1 V/V	Solenoid valve (4 Way valve)	EXTERNAL CONTROL	Connector (Output EXTERNAL CONTROL)
MAIN COOLING	Solenoid valve (Main cooling)	EXTERNAL OUTPUT	Connector (Output EXTERNAL)

NOTE

- This wiring diagram applies only to the outdoor unit.
- Colors blk: black, red: red, blu: blue, wht: white, yel: yellow, brn: brown, sky: skyblue
- When operating, don't shortcircuit the protection device (High Pressure switch)
- For connection wiring indoor-outdoor transmission F1-F2, outdoor_outdoor transmission OF1-OF2, refer to the installation manual.
- Protective earth(screw), : connector, : The wire quantity

7. Sound Data

Summary

Premium energy efficiency

Capacity		Model Name	Sound Pressure dB(A)		Sound Power dB(A)
HP	kW		Cooling	Heating	
8	22.4	AM080AXVGGH/EU	53	58	75
10	28.0	AM100AXVGGH/EU	56	60	78
12	33.6	AM120AXVGGH/EU	61	63	81
14	40.0	AM140AXVGGH/EU	58	61	81
16	45.0	AM160AXVGGH/EU	58	61	81
18	50.4	AM180AXVGGH/EU	59	63	81
20	56.0	AM200AXVGGH/EU	61	63	84
22	61.6	AM220AXVGGH/EU	64	65	86
24	67.2	AM240AXVGGH/EU	65	67	87
26	72.8	AM260AXVGGH/EU	65	67	87
28	78.4	AM280AXVGGH1EU	61	65	83
30	84.0	AM300AXVGGH1EU	63	66	84
32	89.6	AM320AXVGGH1EU	64	66	86
34	95.4	AM340AXVGGH1EU	62	65	84
36	100.8	AM360AXVGGH1EU	62	66	84
38	106.4	AM380AXVGGH1EU	63	66	86
40	112.0	AM400AXVGGH1EU	64	66	87
42	117.6	AM420AXVGGH1EU	66	67	88
44	123.2	AM440AXVGGH1EU	66	68	88
46	128.8	AM460AXVGGH1EU	66	68	89
48	134.4	AM480AXVGGH1EU	68	69	90
50	140.0	AM500AXVGGH1EU	68	70	90
52	145.6	AM520AXVGGH1EU	68	70	90
54	151.2	AM540AXVGGH1EU	66	69	88
56	156.8	AM560AXVGGH1EU	67	70	89
58	162.4	AM580AXVGGH1EU	68	70	89
60	168.0	AM600AXVGGH1EU	68	70	90
62	173.6	AM620AXVGGH1EU	68	70	90
64	179.2	AM640AXVGGH1EU	69	71	91
66	184.8	AM660AXVGGH1EU	68	70	90
68	190.4	AM680AXVGGH1EU	68	70	91
70	196.0	AM700AXVGGH1EU	69	71	91
72	201.6	AM720AXVGGH1EU	69	71	91
74	207.2	AM740AXVGGH1EU	69	71	91
76	212.8	AM760AXVGGH1EU	70	72	92
78	218.4	AM780AXVGGH1EU	70	72	92
80	224.8	AM800AXVGGH1EU	68	70	91
82	229.8	AM820AXVGGH1EU	68	70	91
84	235.2	AM840AXVGGH1EU	68	70	91
86	240.8	AM860AXVGGH1EU	68	70	91
88	246.4	AM880AXVGGH1EU	69	71	91
90	252.0	AM900AXVGGH1EU	69	71	91
92	257.6	AM920AXVGGH1EU	69	71	92
94	263.2	AM940AXVGGH1EU	70	72	92
96	268.8	AM960AXVGGH1EU	70	72	92
98	274.4	AM980AXVGGH1EU	70	72	92

Standard

Capacity		Model Name	Sound Pressure dB(A)		Sound Power dB(A)
HP	kW		Cooling	Heating	
8	22.4	AM080AXVAGH/EU	53	58	75
10	28.0	AM100AXVAGH/EU	56	60	78
12	33.6	AM120AXVAGH/EU	61	63	81
14	40.0	AM140AXVAGH/EU	63	65	85
16	45.0	AM160AXVAGH/EU	60	62	81
18	50.4	AM180AXVAGH/EU	61	64	83
20	56.0	AM200AXVAGH/EU	61	63	84
22	61.6	AM220AXVAGH/EU	64	65	86
24	67.2	AM240AXVAGH/EU	65	67	87
26	72.8	AM260AXVAGH/EU	65	67	87
28	78.4	AM280AXVAGH1EU	62	64	85
30	84.0	AM300AXVAGH1EU	64	67	85
32	89.6	AM320AXVAGH1EU	65	68	87
34	95.2	AM340AXVAGH1EU	66	68	88
36	100.8	AM360AXVAGH1EU	66	68	88
38	107.2	AM380AXVAGH1EU	67	69	89
40	112.2	AM400AXVAGH1EU	66	68	88
42	117.6	AM420AXVAGH1EU	66	69	88
44	123.2	AM440AXVAGH1EU	66	68	89
46	128.8	AM460AXVAGH1EU	68	69	90
48	134.4	AM480AXVAGH1EU	68	70	90
50	140.0	AM500AXVAGH1EU	68	70	90
52	145.6	AM520AXVAGH1EU	68	70	90
54	151.2	AM540AXVAGH1EU	68	70	89
56	156.8	AM560AXVAGH1EU	68	70	90
58	162.4	AM580AXVAGH1EU	68	70	90
60	168.0	AM600AXVAGH1EU	69	71	91
62	174.4	AM620AXVAGH1EU	69	71	91
64	179.4	AM640AXVAGH1EU	69	71	91
66	184.8	AM660AXVAGH1EU	69	71	91
68	190.4	AM680AXVAGH1EU	69	71	91
70	196.0	AM700AXVAGH1EU	69	71	91
72	201.6	AM720AXVAGH1EU	70	72	92
74	207.2	AM740AXVAGH1EU	70	72	92
76	212.8	AM760AXVAGH1EU	70	72	92
78	218.4	AM780AXVAGH1EU	70	72	92
80	224.0	AM800AXVAGH1EU	70	72	92
82	229.6	AM820AXVAGH1EU	70	72	92
84	235.2	AM840AXVAGH1EU	70	72	92
86	241.6	AM860AXVAGH1EU	71	73	93
88	246.6	AM880AXVAGH1EU	70	72	92
90	252.0	AM900AXVAGH1EU	70	72	92
92	257.6	AM920AXVAGH1EU	70	72	92
94	263.2	AM940AXVAGH1EU	71	73	93
96	268.8	AM960AXVAGH1EU	71	73	93
98	274.4	AM980AXVAGH1EU	71	73	93

7. Sound Data

Sound Pressure level

Unit: dB(A)

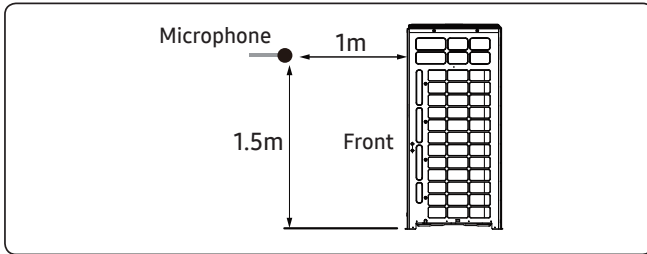

Model	Cooling	Silent 1	Silent 2	Silent 3
AM080AXVGGH/EU	53	52	51	49
AM100AXVGGH/EU	56	54	52	49
AM120AXVGGH/EU	61	59	54	49
AM140AXVGGH/EU	58	57	55	49

- NR Curve

1) AM080AXVGGH/EU

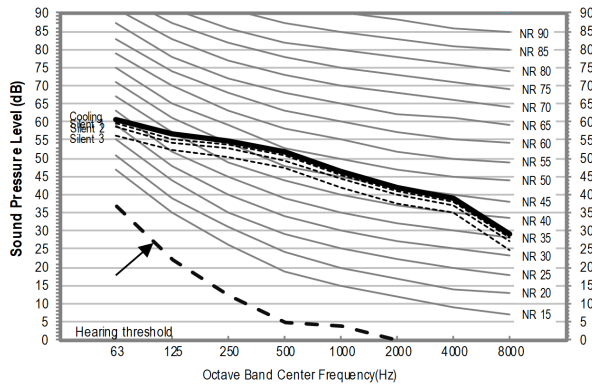

2) AM100AXVGGH/EU

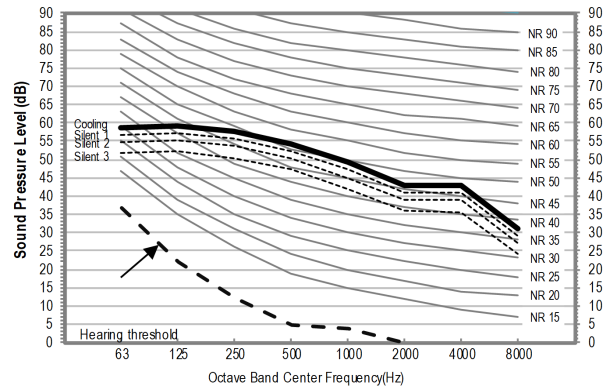

3) AM120AXVGGH/EU

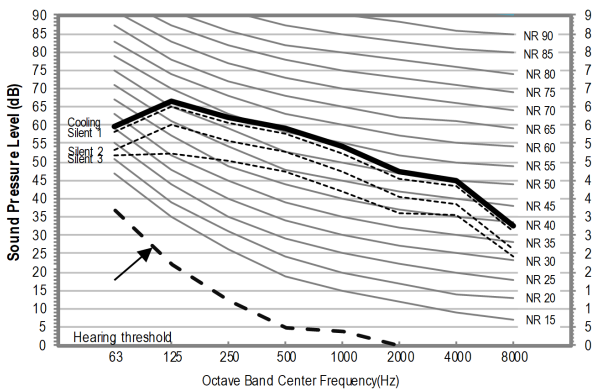

4) AM140AXVGGH/EU

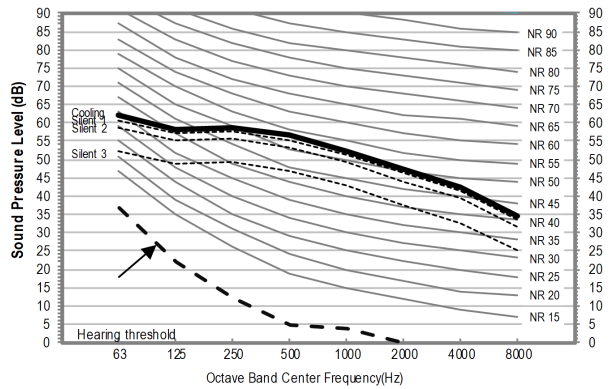

NOTE

- Specifications may be subject to change without prior notice.
 - Sound pressure level is obtained in an anechoic room.
 - Sound pressure level is a relative value, depending on the distance and acoustic environment.
 - Sound pressure level may differ depending on operation condition.
 - dB(A) = A-weighted sound pressure level
 - Reference acoustic pressure 0 dB = 20μPa

7. Sound Data

Sound Pressure level

Unit: dB(A)

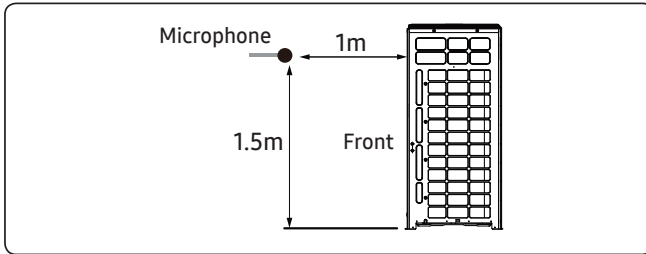

Model	Cooling	Silent 1	Silent 2	Silent 3
AM160AXVGGH/EU	58	57	55	49
AM180AXVGGH/EU	59	57	55	49
AM200AXVGGH/EU	61	57	55	49
AM220AXVGGH/EU	64	61	56	49

- NR Curve

1) AM160AXVGGH/EU

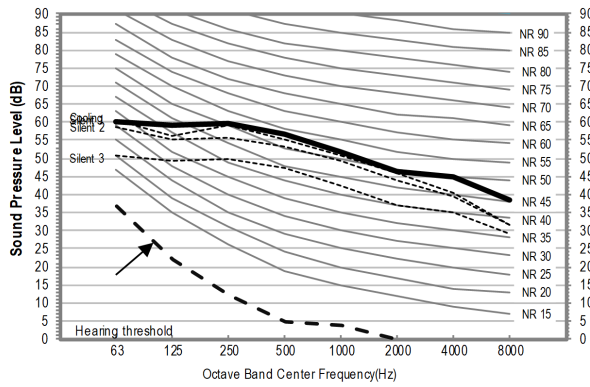

2) AM180AXVGGH/EU

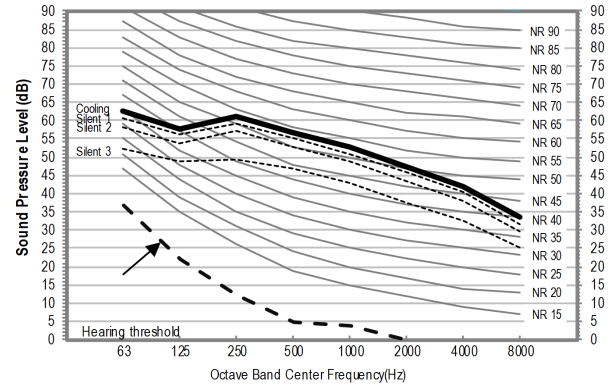

3) AM200AXVGGH/EU

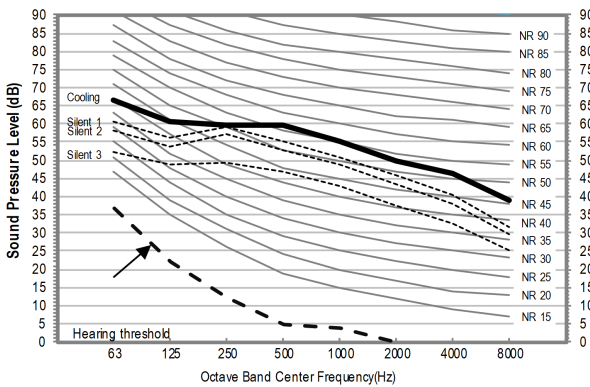

4) AM220AXVGGH/EU

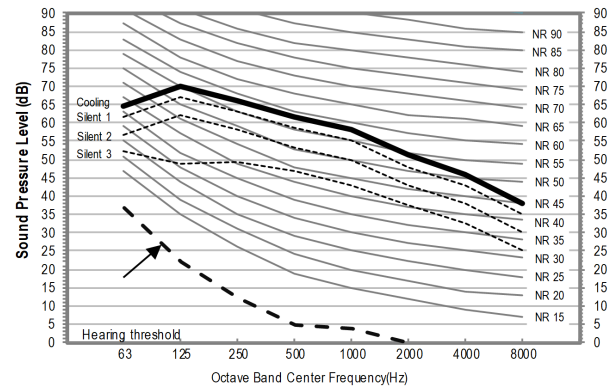

NOTE

- Specifications may be subject to change without prior notice.
 - Sound pressure level is obtained in an anechoic room.
 - Sound pressure level is a relative value, depending on the distance and acoustic environment.
 - Sound pressure level may differ depending on operation condition.
 - dB(A) = A-weighted sound pressure level
 - Reference acoustic pressure 0 dB = 20μPa

7. Sound Data

Sound Pressure level

Unit: dB(A)

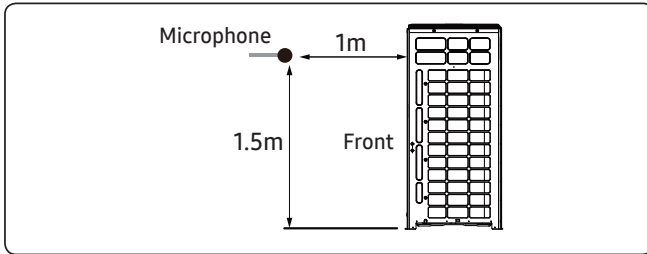

Model	Cooling	Silent 1	Silent 2	Silent 3
AM240AXVGGH/EU	65	62	57	49
AM260AXVGGH/EU	65	62	57	49

- NR Curve

1) AM240AXVGGH/EU

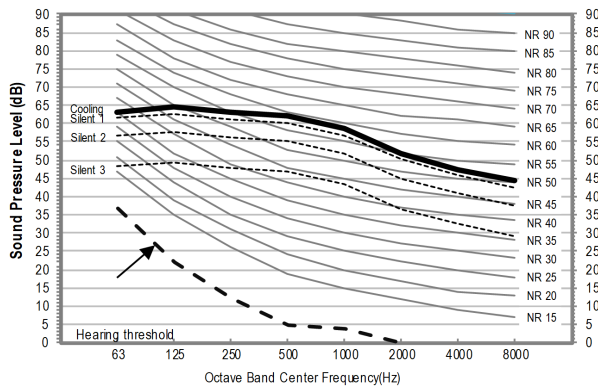

2) AM260AXVGGH/EU

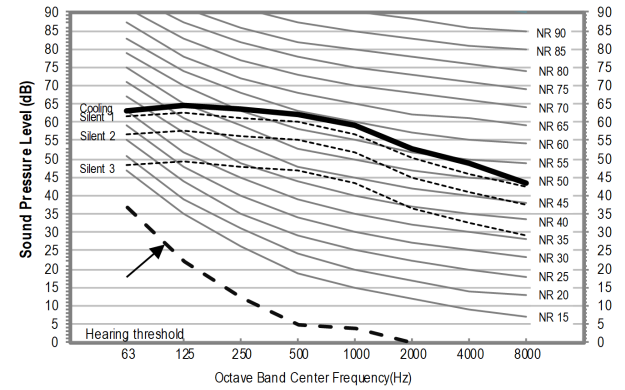

NOTE

- Specifications may be subject to change without prior notice.
 - Sound pressure level is obtained in an anechoic room.
 - Sound pressure level is a relative value, depending on the distance and acoustic environment.
 - Sound pressure level may differ depending on operation condition.
 - dBA = A-weighted sound pressure level
 - Reference acoustic pressure 0 dB = 20μPa

7. Sound Data

Sound Pressure level

Unit: dB(A)

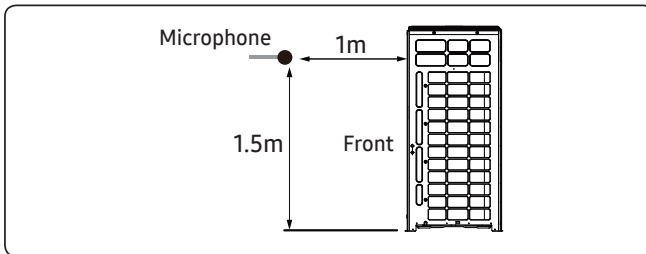

Model	Cooling	Silent 1	Silent 2	Silent 3
AM080AXVAGH/EU	53	52	51	49
AM100AXVAGH/EU	56	54	52	49
AM120AXVAGH/EU	61	59	54	49
AM140AXVAGH/EU	63	59	54	49

- NR Curve

1) AM080AXVAGH/EU

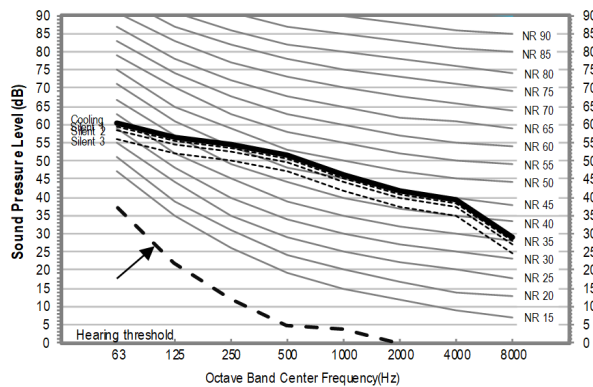

2) AM100AXVAGH/EU

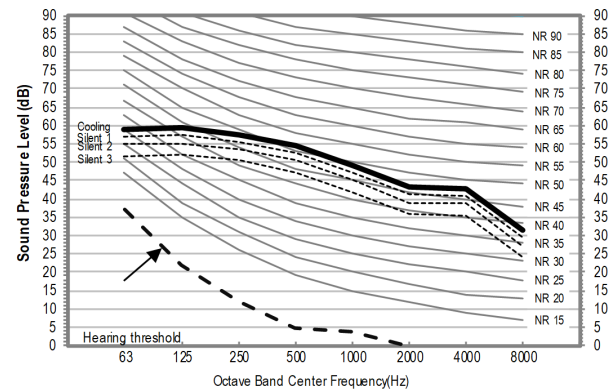

3) AM120AXVAGH/EU

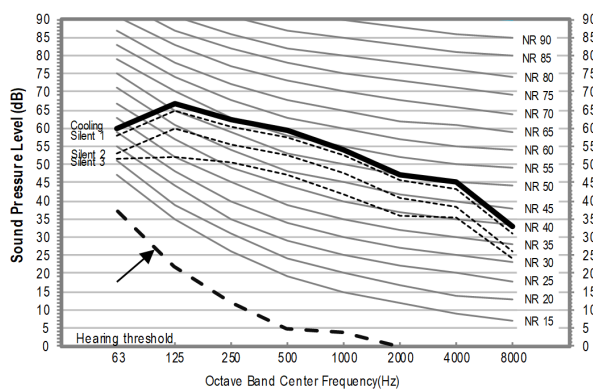

4) AM140AXVAGH/EU

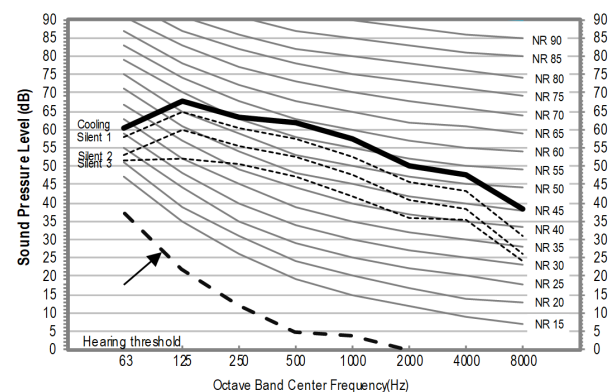

NOTE

- Specifications may be subject to change without prior notice.
 - Sound pressure level is obtained in an anechoic room.
 - Sound pressure level is a relative value, depending on the distance and acoustic environment.
 - Sound pressure level may differ depending on operation condition.
 - dB(A) = A-weighted sound pressure level
 - Reference acoustic pressure 0 dB = 20μPa

7. Sound Data

Sound Pressure level

Unit: dB(A)

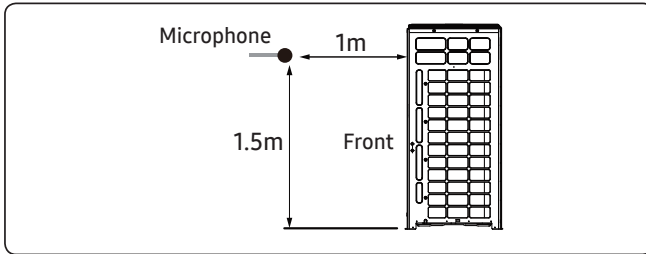

Model	Cooling	Silent 1	Silent 2	Silent 3
AM160AXVAGH/EU	60	57	55	49
AM180AXVAGH/EU	61	57	55	49
AM200AXVAGH/EU	61	57	55	49
AM220AXVAGH/EU	64	61	56	49

- NR Curve

1) AM160AXVAGH/EU

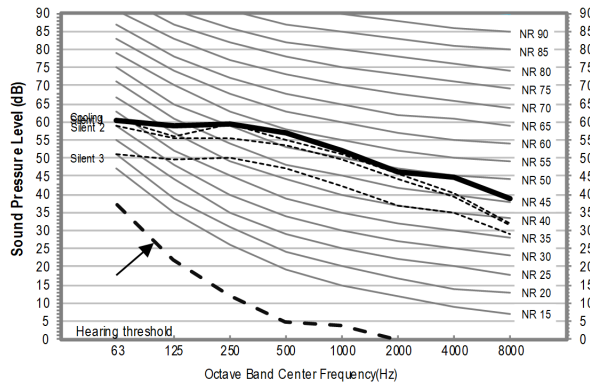

2) AM180AXVAGH/EU

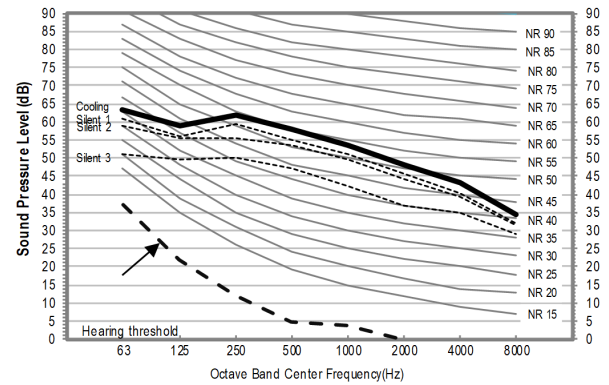

3) AM200AXVAGH/EU

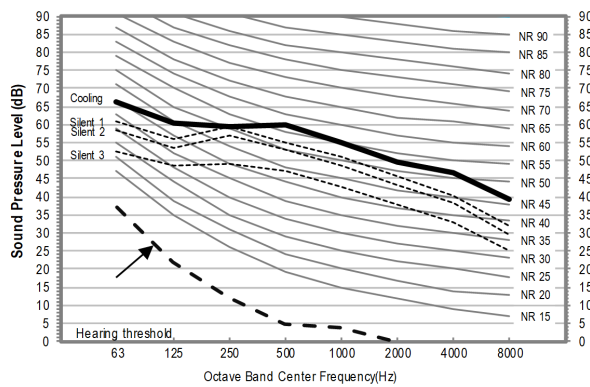

4) AM220AXVAGH/EU

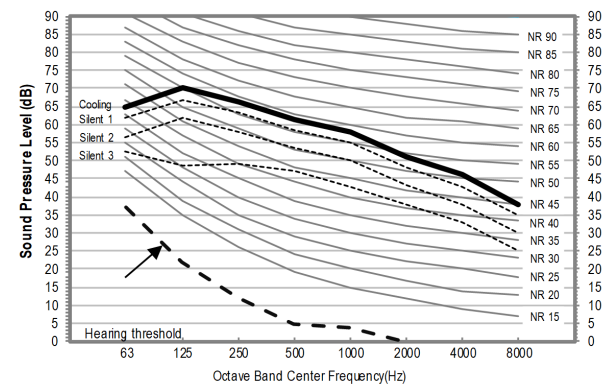

NOTE

- Specifications may be subject to change without prior notice.
 - Sound pressure level is obtained in an anechoic room.
 - Sound pressure level is a relative value, depending on the distance and acoustic environment.
 - Sound pressure level may differ depending on operation condition.
 - dB(A) = A-weighted sound pressure level
 - Reference acoustic pressure 0 dB = 20μPa

7. Sound Data

Sound Pressure level

Unit: dB(A)

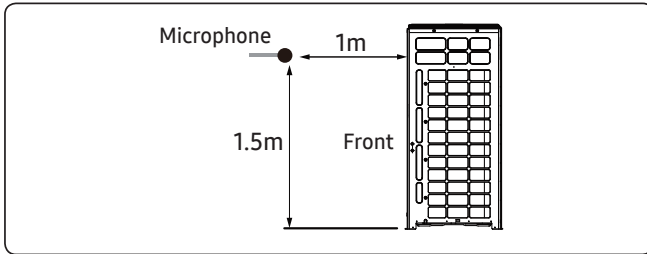

Model	Cooling	Silent 1	Silent 2	Silent 3
AM240AXVAGH/EU	65	62	57	49
AM260AXVAGH/EU	65	62	57	49

- NR Curve

1) AM240AXVAGH/EU

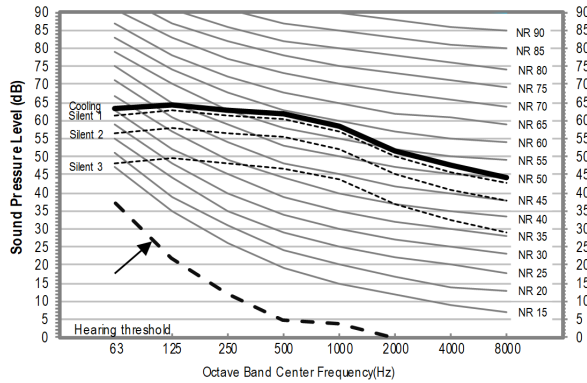

2) AM260AXVAGH/EU

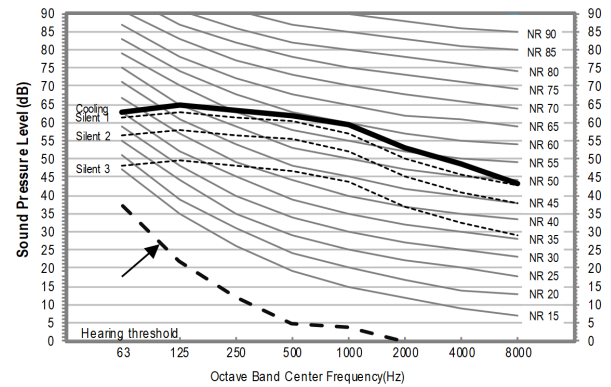

NOTE

- Specifications may be subject to change without prior notice.
 - Sound pressure level is obtained in an anechoic room.
 - Sound pressure level is a relative value, depending on the distance and acoustic environment.
 - Sound pressure level may differ depending on operation condition.
 - dB(A) = A-weighted sound pressure level
 - Reference acoustic pressure 0 dB = 20μPa

7. Sound Data

Sound Power level

Unit: dB(A)

Model	Power
AM080AXVGGH/EU	75
AM100AXVGGH/EU	78
AM120AXVGGH/EU	81
AM140AXVGGH/EU	81

- NR Curve

1) AM080AXVGGH/EU

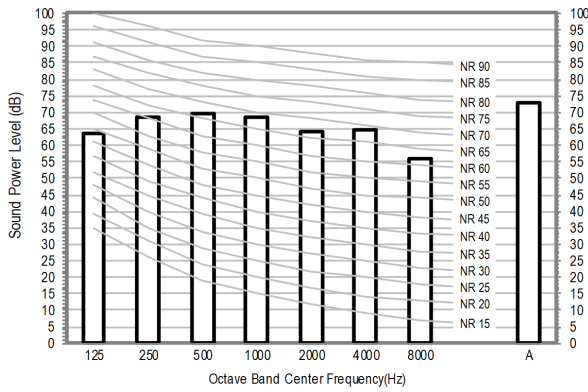

2) AM100AXVGGH/EU

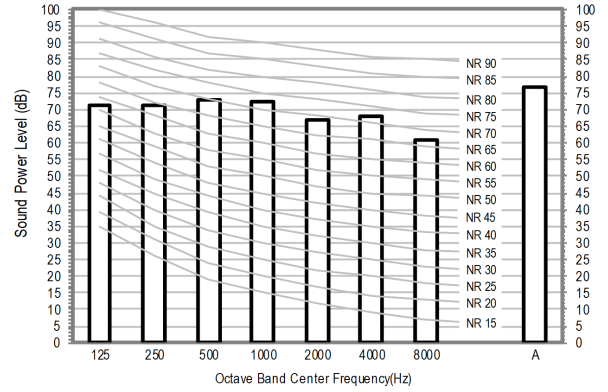

3) AM120AXVGGH/EU

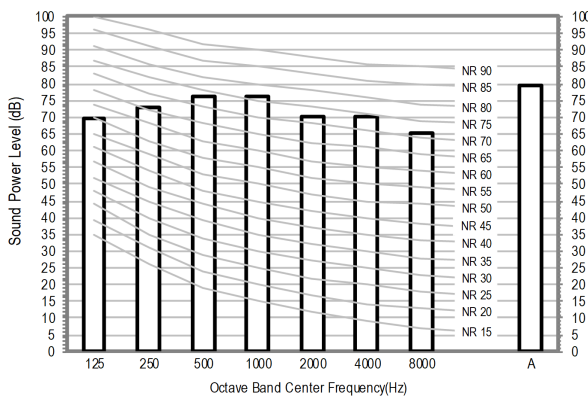

4) AM140AXVGGH/EU

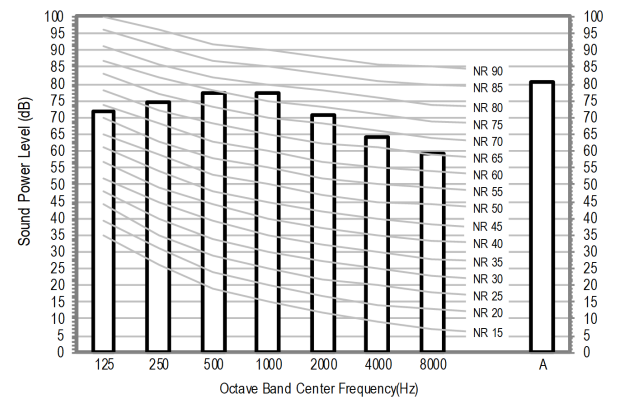

NOTE

- Specifications may be subject to change without prior notice.
 - Sound power level is an absolute value that a sound source generates.
 - dBA = A-weighted sound power level.
 - Reference power : 1pW.
 - Measured according to ISO 3741.

7. Sound Data

Sound Power level

Unit: dB(A)

Model	Power
AM160AXVGGH/EU	81
AM180AXVGGH/EU	81
AM200AXVGGH/EU	84
AM220AXVGGH/EU	86

- NR Curve

1) AM160AXVGGH/EU

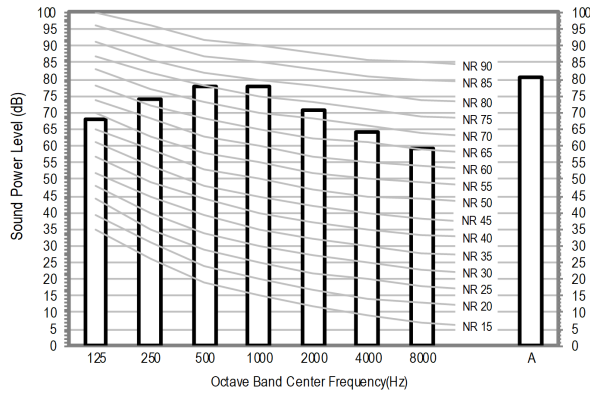

2) AM180AXVGGH/EU

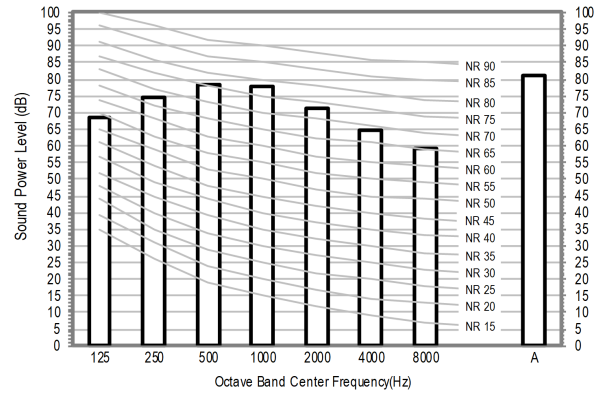

3) AM200AXVGGH/EU

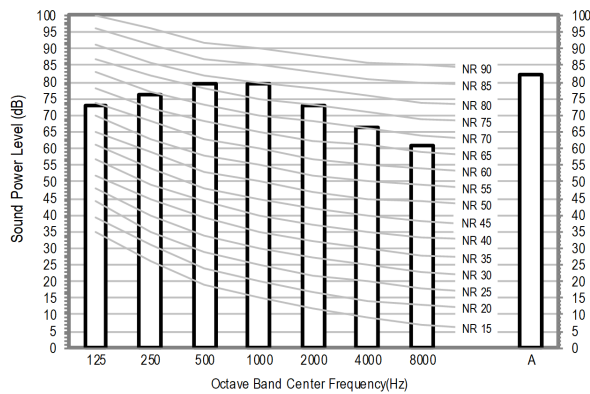

4) AM220AXVGGH/EU

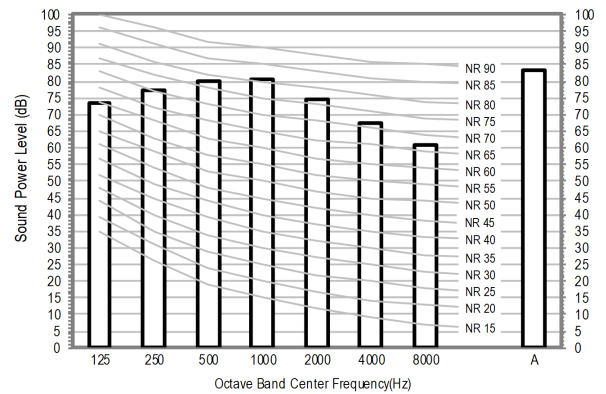

NOTE

- Specifications may be subject to change without prior notice.
 - Sound power level is an absolute value that a sound source generates.
 - dBA = A-weighted sound power level.
 - Reference power : 1pW.
 - Measured according to ISO 3741.

7. Sound Data

Sound Power level

Unit: dB(A)

Model	Power
AM240AXVGGH/EU	87
AM260AXVGGH/EU	87

- NR Curve

1) AM240AXVGGH/EU

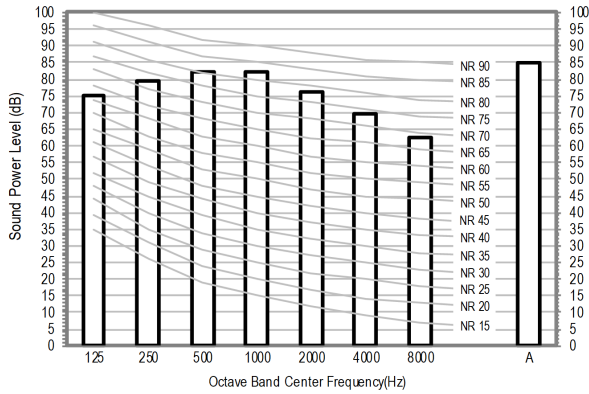

2) AM260AXVGGH/EU

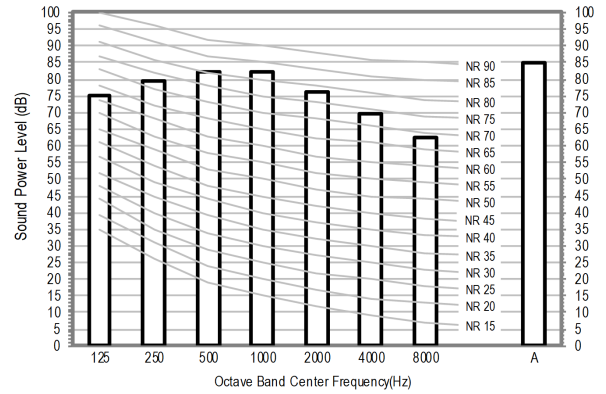

NOTE

- Specifications may be subject to change without prior notice.
 - Sound power level is an absolute value that a sound source generates.
 - dBA = A-weighted sound power level.
 - Reference power : 1pW.
 - Measured according to ISO 3741.

7. Sound Data

Sound Power level

Unit: dB(A)

Model	Power
AM080AXVAGH/EU	75
AM100AXVAGH/EU	78
AM120AXVAGH/EU	81
AM140AXVAGH/EU	85

- NR Curve

1) AM080AXVAGH/EU

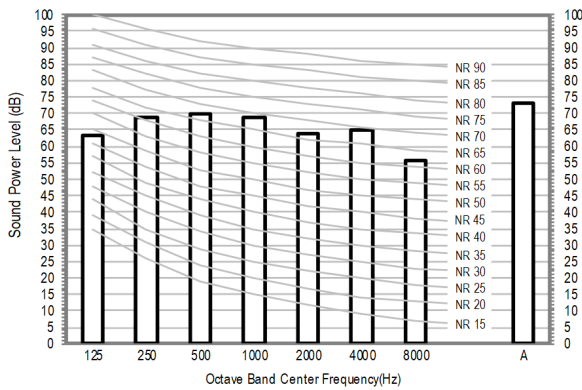

2) AM100AXVAGH/EU

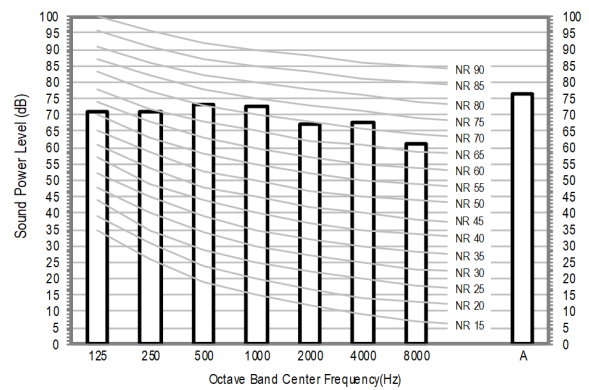

3) AM120AXVAGH/EU

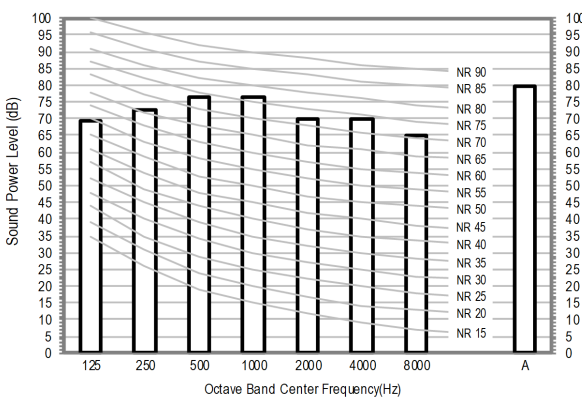

4) AM140AXVAGH/EU

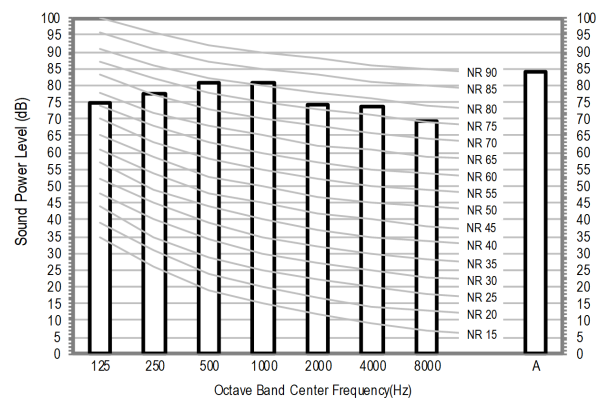

NOTE

- Specifications may be subject to change without prior notice.
 - Sound power level is an absolute value that a sound source generates.
 - dBA = A-weighted sound power level.
 - Reference power : 1pW.
 - Measured according to ISO 3741.

7. Sound Data

Sound Power level

Unit: dB(A)

Model	Power
AM160AXVAGH/EU	81
AM180AXVAGH/EU	83
AM200AXVAGH/EU	84
AM220AXVAGH/EU	86

- NR Curve

1) AM160AXVAGH/EU

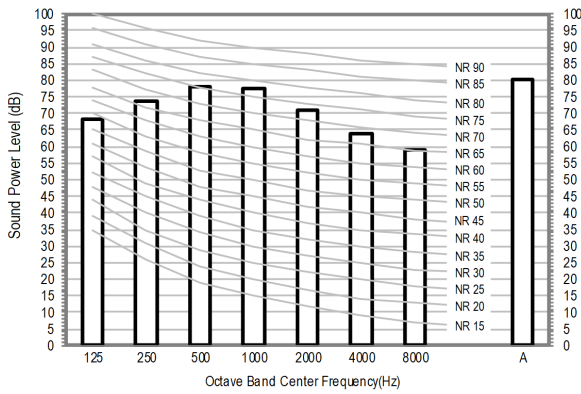

2) AM180AXVAGH/EU

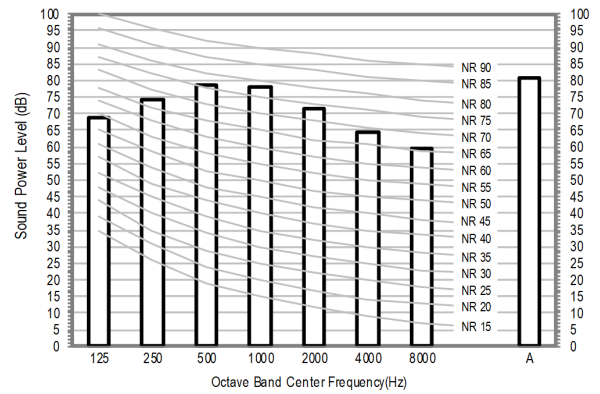

3) AM200AXVAGH/EU

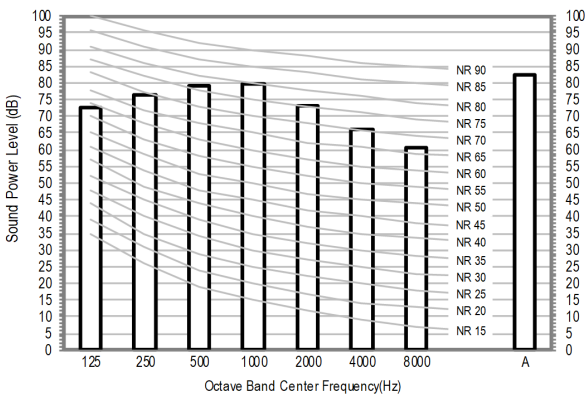

4) AM220AXVAGH/EU

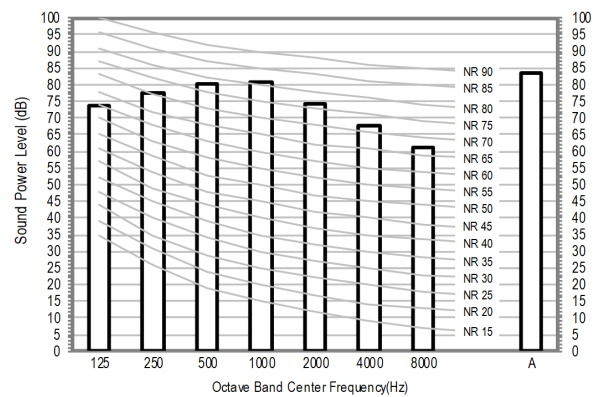

NOTE

- Specifications may be subject to change without prior notice.
 - Sound power level is an absolute value that a sound source generates.
 - dBA = A-weighted sound power level.
 - Reference power : 1pW.
 - Measured according to ISO 3741.

7. Sound Data

Sound Power level

Unit: dB(A)

Model	Power
AM240AXVAGH/EU	87
AM260AXVAGH/EU	87

- NR Curve

1) AM240AXVAGH/EU

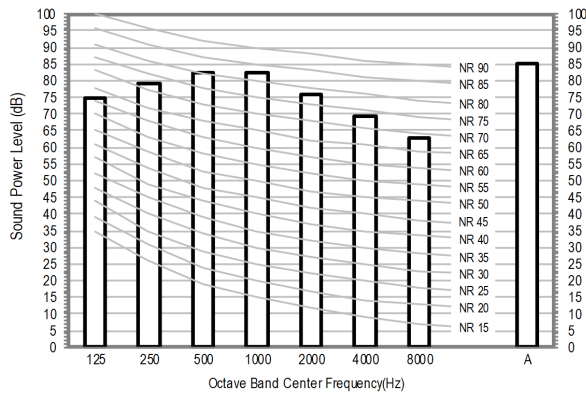

2) AM260AXVAGH/EU

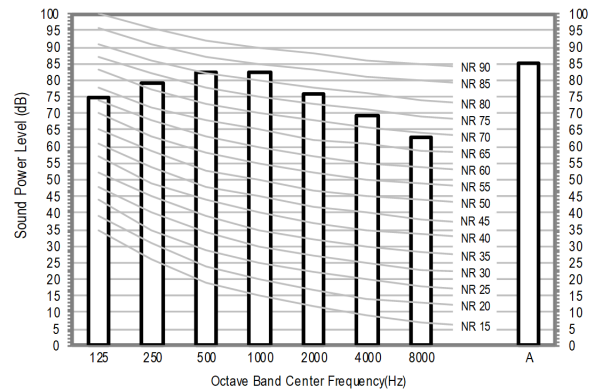

NOTE

- Specifications may be subject to change without prior notice.
 - Sound power level is an absolute value that a sound source generates.
 - dBA = A-weighted sound power level.
 - Reference power : 1pW.
 - Measured according to ISO 3741.

8. Operation Range

Cooling

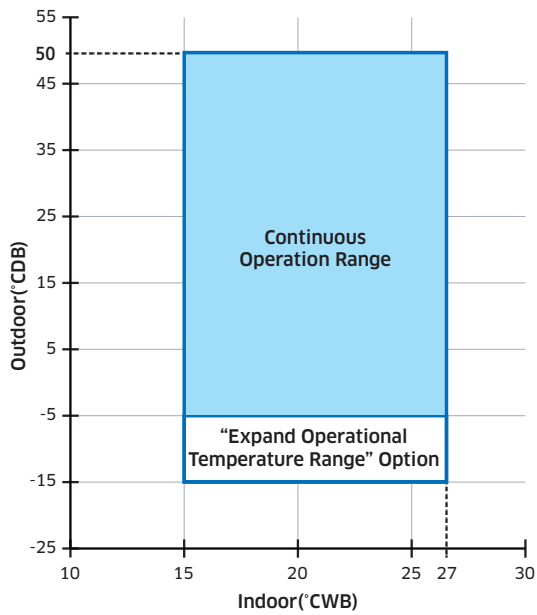

Heating

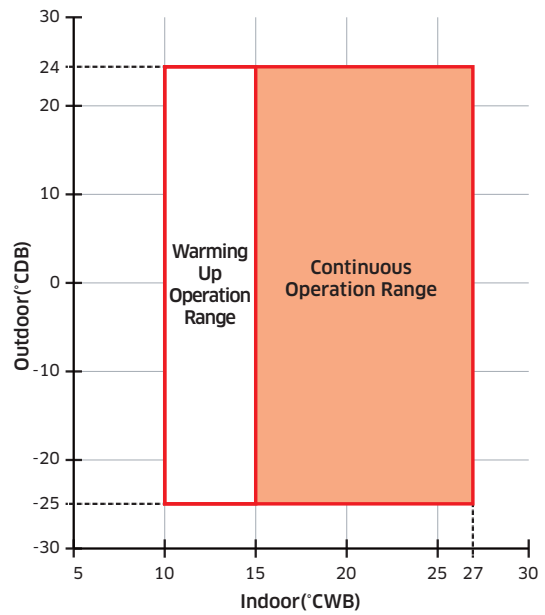

- (1) The operating range is shown in these figures
- (2) The assumed installation conditions are as follows
 - Outdoor units and indoor units combination
 - The Pipe length(including elbow) is 5m
 - The Level difference is 0m
- (3) In the low temperature expansion option application, the cooling operating is possible under expand operational range only for HR system
- (4) In case of heating mode, operating is possible under warming up operation range. However continuous operating is impossible due to a protection control

8. Operation Range

Defrosting correction factor

The heating capacity tables do not take account of the reduction in capacity, when frost has accumulated or while the defrosting operation is in progress.

The capacity values, which take these factors into account, in other words, the integrated heating capacity values, can be calculated as follows :

Formula : $A = B \times C$

Integrated heating capacity = A

Value given in table of capacity characteristics = B

Integrating correction factor for frost accumulation (kW) = C

Outdoor temperature (°C, DB/WB)	-10/-10.4	-8/-8.5	-6/-6.5	-4/-4.6	-2/-2.7	0/-0.7	2/1.2	5/4.1	7/6
Capacity coefficient	0.99	0.98	0.96	0.95	0.91	0.88	0.86	0.91	1.00

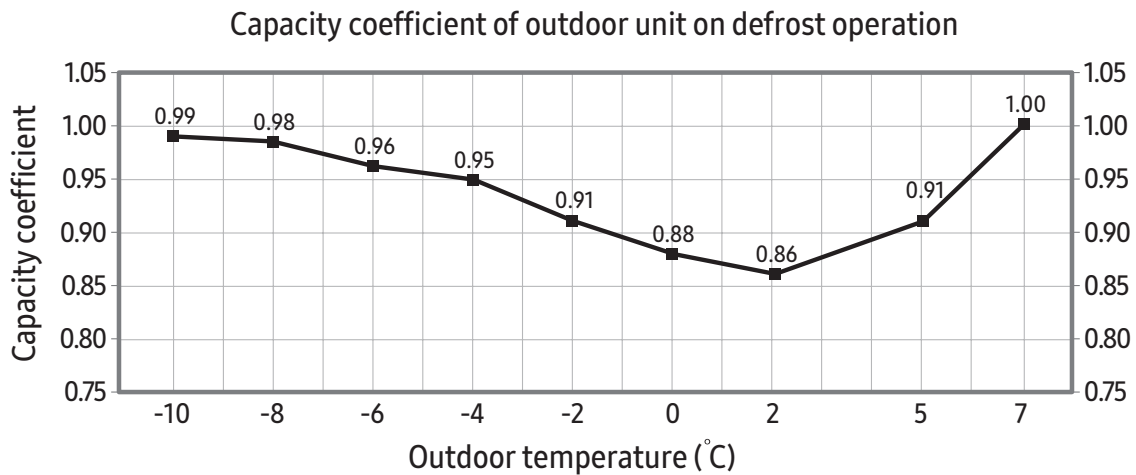

On heating operation, frost can be formed on heat exchanger according to outdoor temperature. (Frost on heat exchanger results in decreasing the performance.)

To remove frost on heat exchanger of outdoor unit, defrost operation is carried out periodically.

During defrost operation, capacity of outdoor unit may decrease.

The decrement is not considered to the individual capacity tables.

This figure shows an effect of intelligence defrost operation

It is actually the frost occurrence section from 0 °C or less.

Since the outdoor temperature over 0 °C, the heating performance is the same before and after applying intelligence defrost operation

In outdoor conditions below 0 °C, frost conditions reflect the actual entering the defrost operation because heating performance is improved

9. Piping Diagram

Outdoor unit

(1) AM080~120AXVGGH, AM080~140AXVAGH

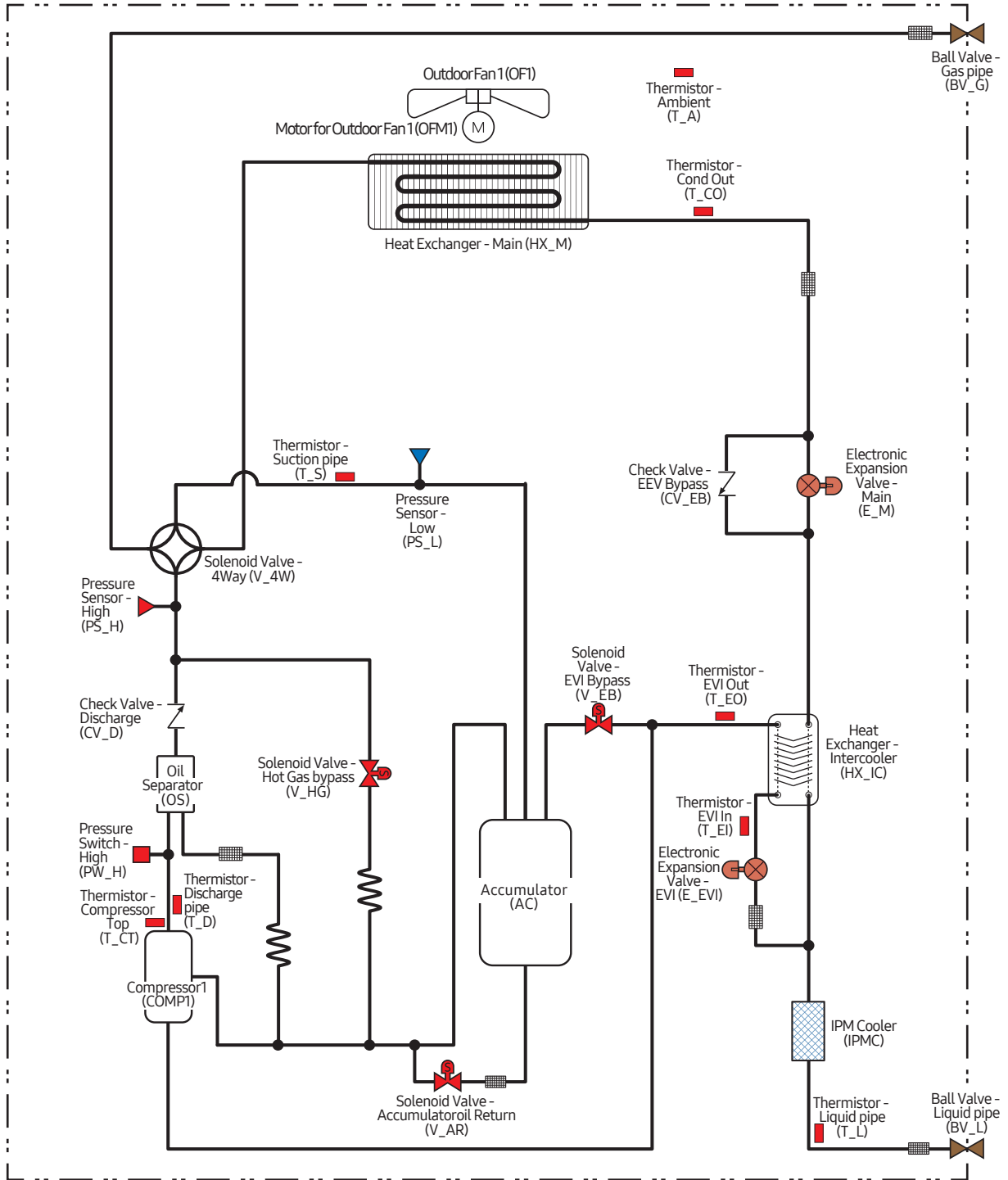

9. Piping Diagram

Outdoor unit

(2) AM140~AM200AXVGGH, AM160~AM200AXVAGH

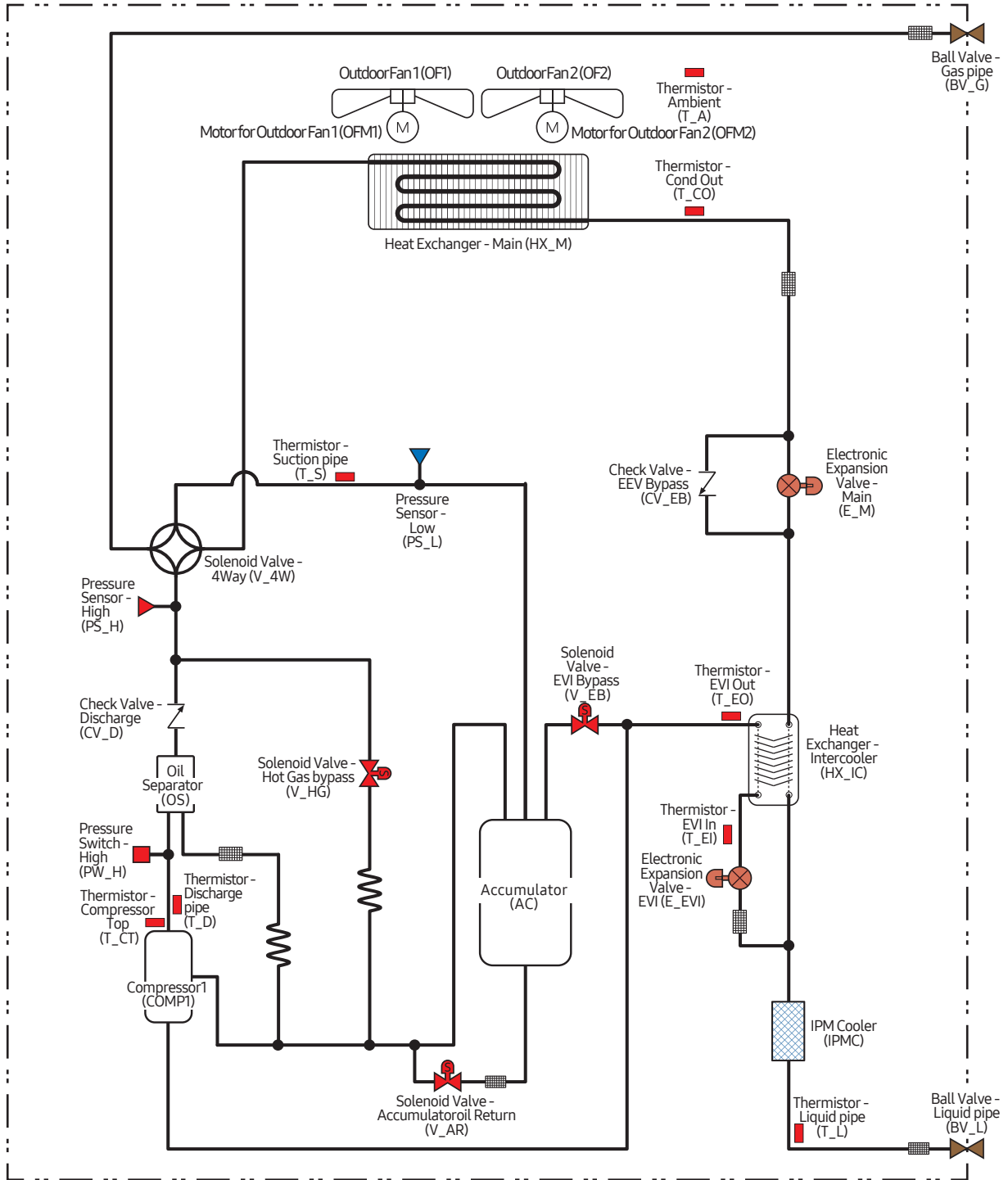

9. Piping Diagram

Outdoor unit

(3) AM220AXVGGH, AM220AXVAGH

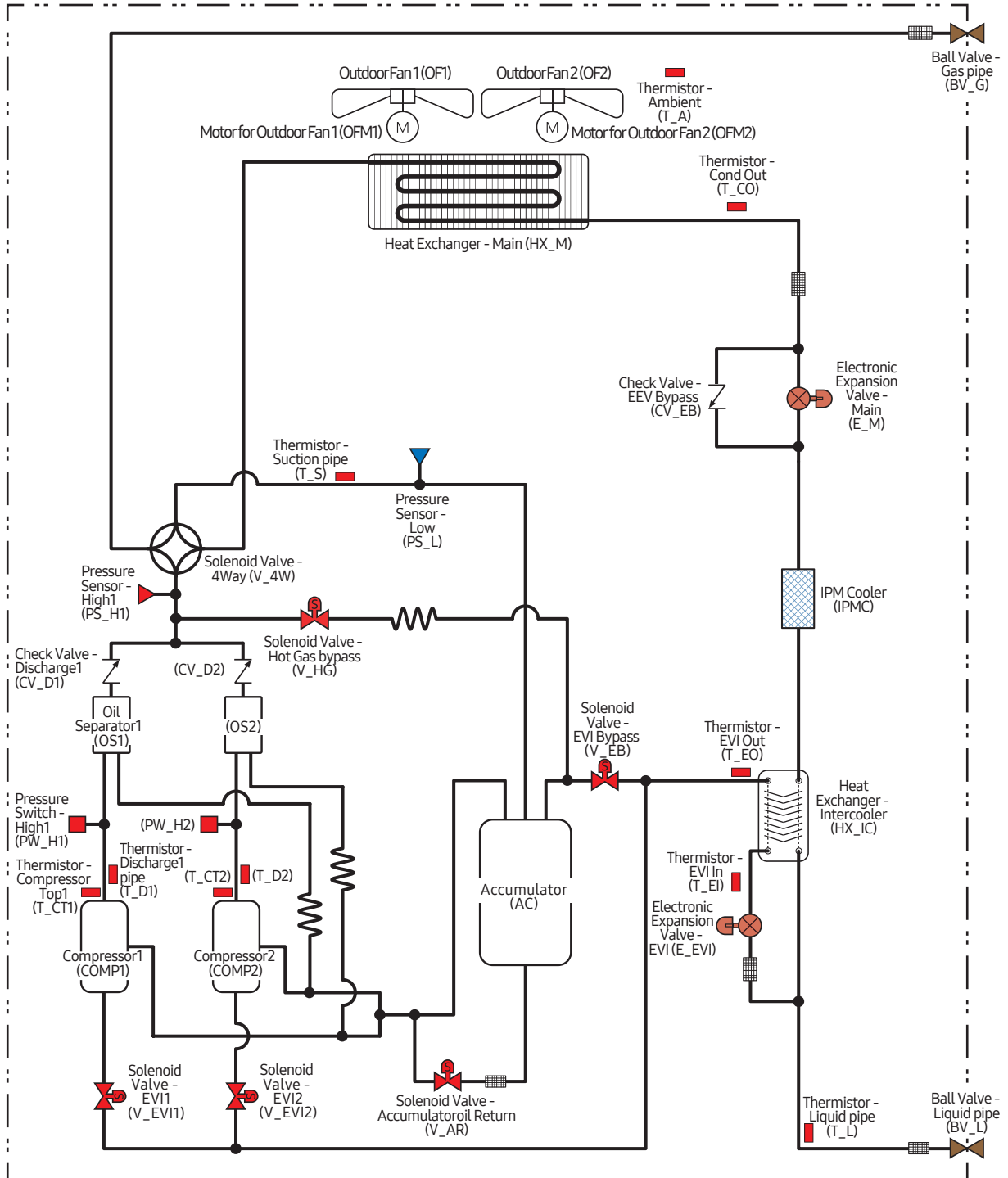

9. Piping Diagram

Outdoor unit

(4) AM240~260AXVGGH, AM240~260AXVAGH,

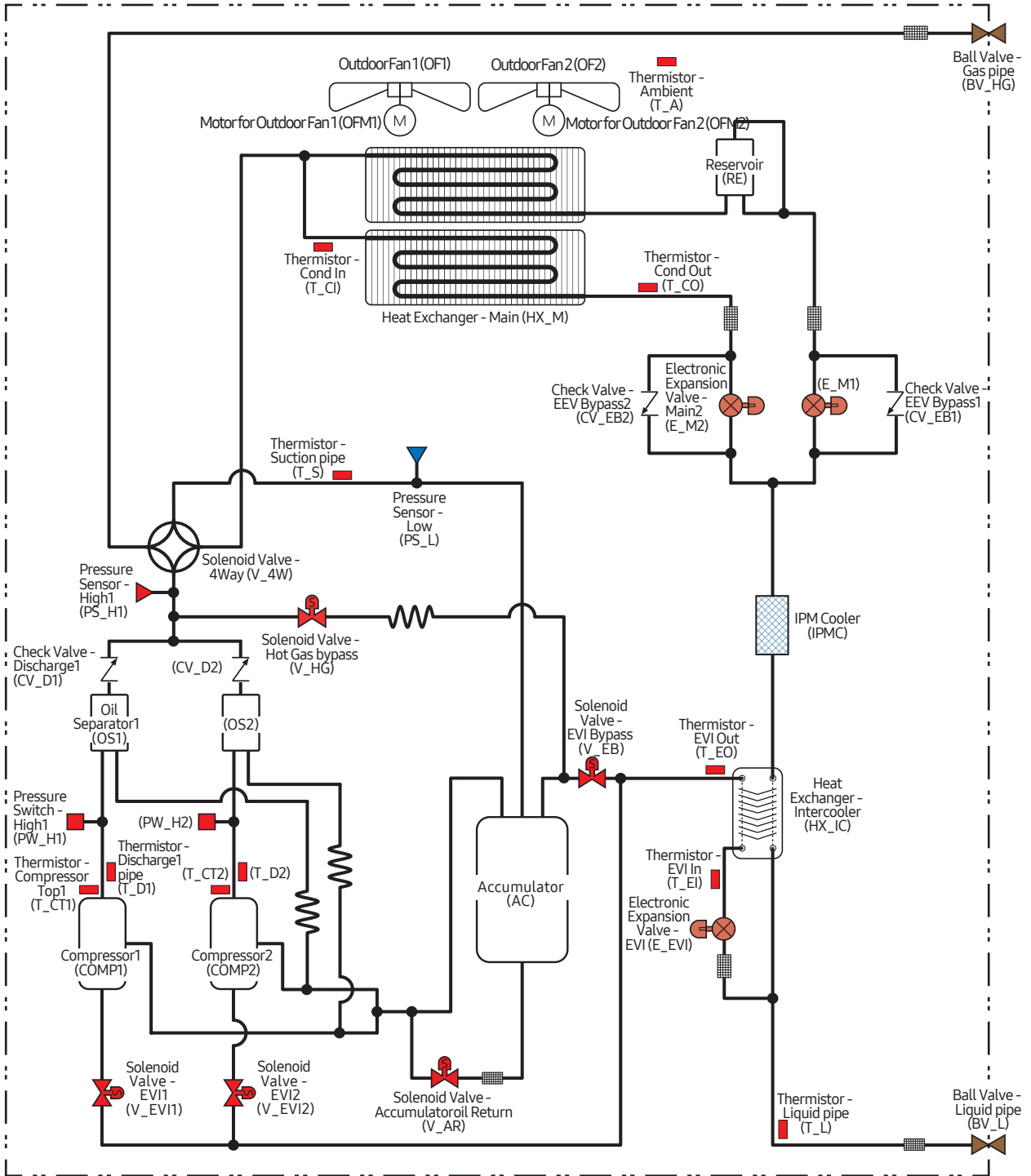

9. Piping Diagram

Cooling System

- 22HP with indoor units

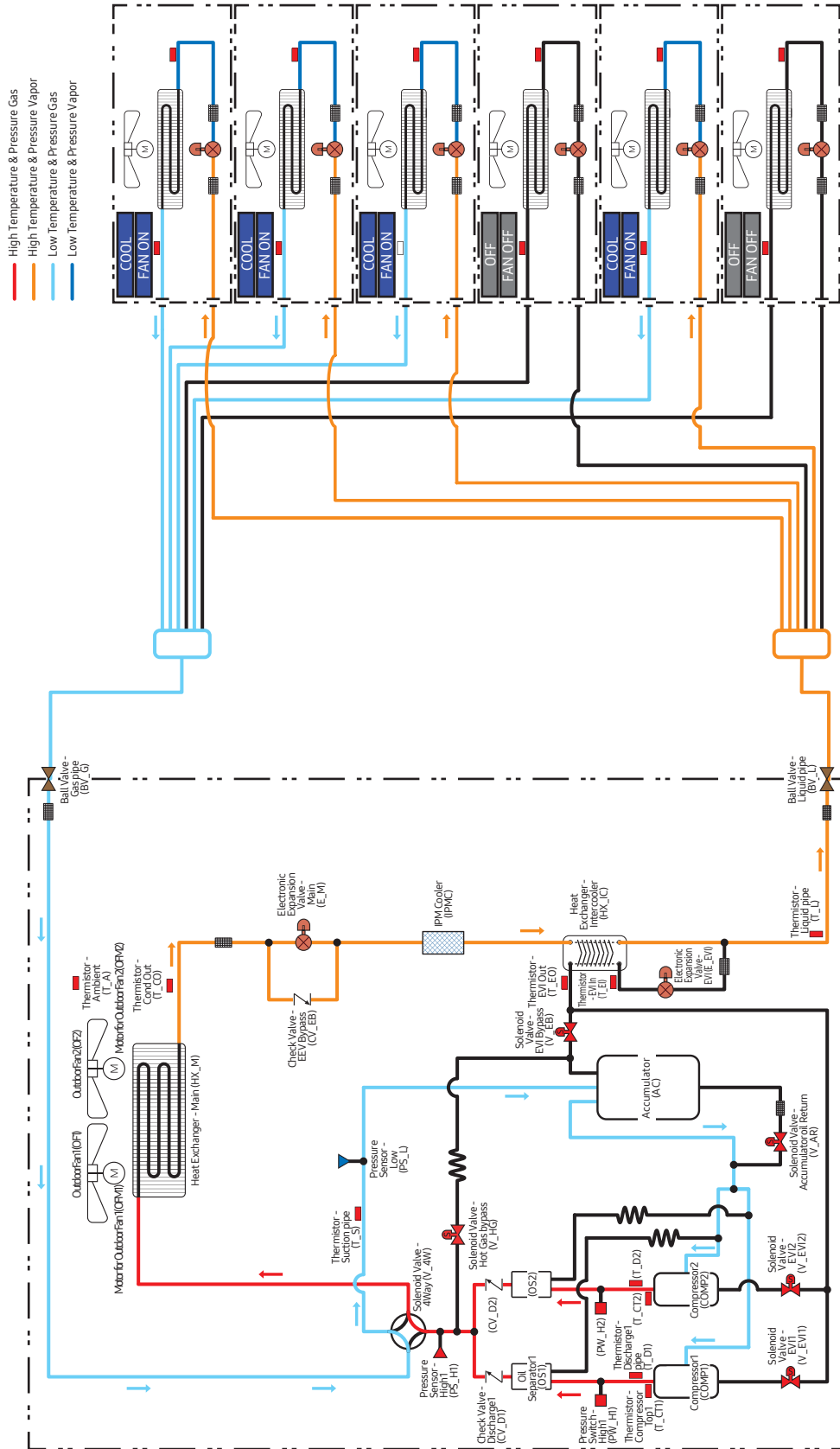

9. Piping Diagram

Heating System

- 22HP with indoor units

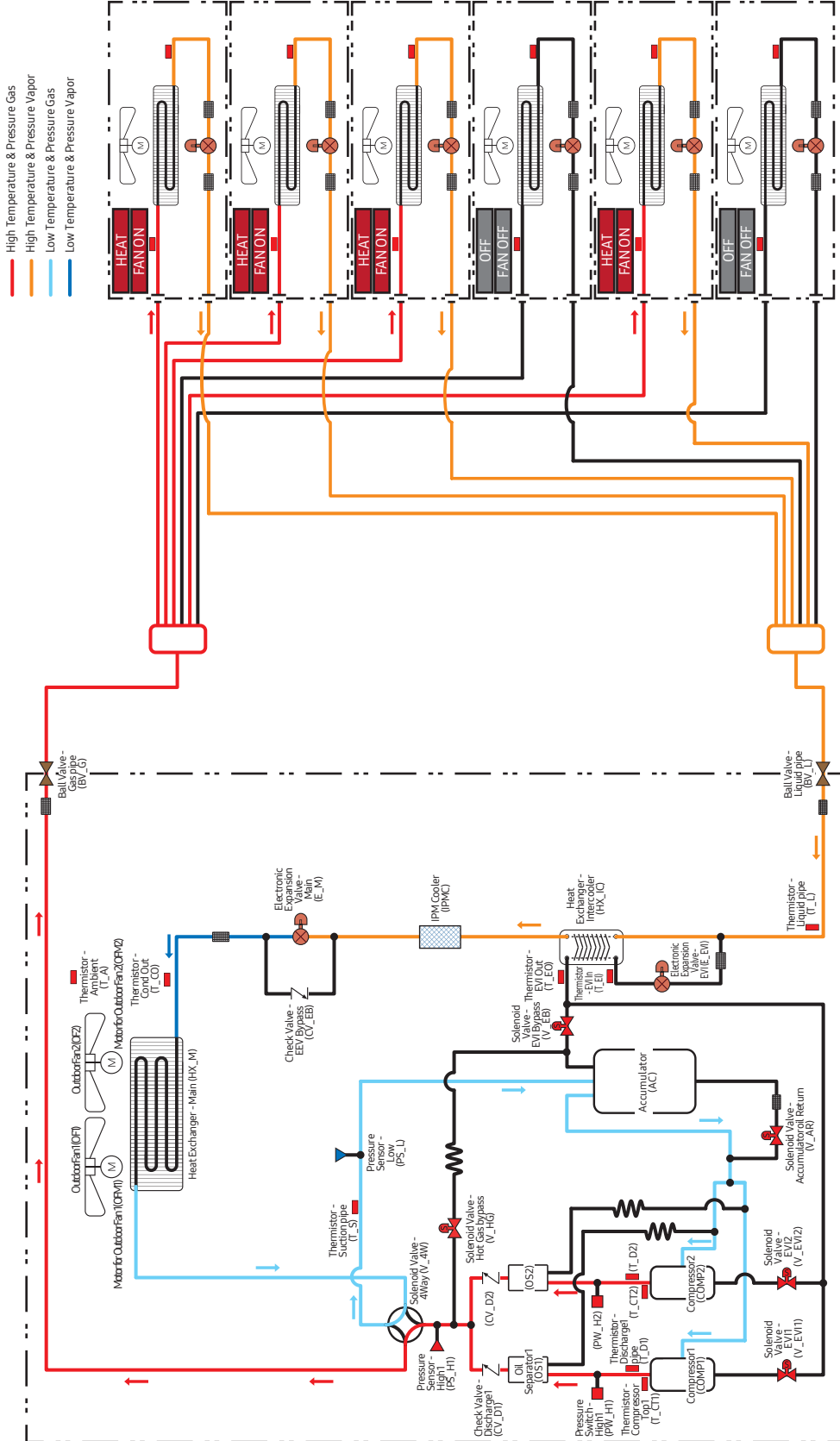

10. Installation

Outdoor unit

Outdoor unit location requirements

Decide the installation location, with the consideration of the following conditions, under user's approval.

- Place where hot discharge air or noise from the outdoor unit may not disturb the neighbor (Especially in residential areas, keep the operation hours in mind.)
- Place where structure can bear the weight and vibration of the outdoor unit.
- Place with flat surface where rainwater does not settle or leak.
- Place where it is not exposed to strong wind.
- Well ventilated place with sufficient service place for repairs and maintenance. (Discharge duct can be purchased separately)
- Place where you can connect the refrigerant pipes between indoor and outdoor units within allowable distance.
- Place where it allows easy waterproofing and draining work for the condensation water generated from the outdoor unit during heating operation.
- Place where there is no risk of inflammable gas leakage.
- Place where there is no direct influence of snow or rain.
- Place where a large amount of water generated by external environment does not directly affect the top of the outdoor unit.

Installation Guide at the seashore

Make sure to follow below guides when installing at the seashore.

- 1 Do not install the product in a place where it is directly exposed to sea water and sea breeze.
 - Make sure to install the product behind a structure (such as building) that can block sea breeze.
 - Even when it is inevitable to install the product in seashore, make sure that product is not directly exposed to sea breeze by installing a protection wall.

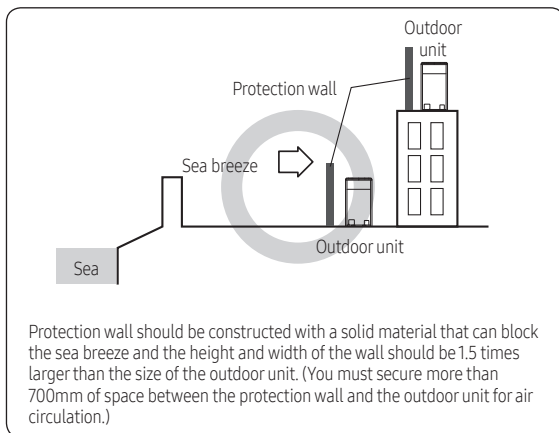

- 2 Consider that the salinity particles clinging to the external panels should be sufficiently washed out.
- 3 Because the residual water at the bottom of the outdoor unit significantly promotes corrosion, make sure that the slope does not disturb drainage.
 - Keep the floor level so that rain does not accumulate.
 - Be careful not to block the drain hole due to foreign substance
- 4 When product is installed in seashore, periodically clean it with water to remove attached salinity.

- 5 Make sure to install the product in a place that provides smooth water drainage. Especially, ensure that the base part has good drainage.
- 6 If the product is damaged during the installation or maintenance, make sure to repair it.
- 7 Check the condition of the product periodically.
 - Check the installation site every 3 months and perform anti-corrosion treatment such as R-Pro supplied by SAMSUNG (Code : MOK-220SA) or commercial water repellent grease and wax, etc., based on the product condition.
 - When the product is to be shut down for a long period of time, such as off-peak hours, take appropriate measures like covering the product.
- 8 If the product installed within 500m of seashore, special anti-corrosion treatment is required.
 - ✧ Please contact your local SAMSUNG representative for further details.

If you cannot find a proper location to install the outdoor unit, consult with an expert or specialty store.

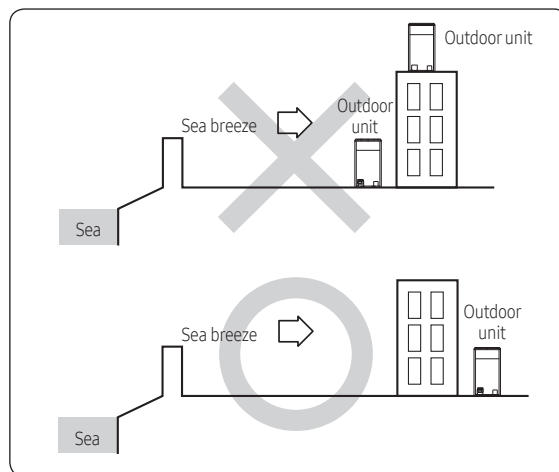

CAUTION

- System air conditioner may cause static noise when listening to AM stations. Therefore, select an installation location for indoor unit where electrical wiring can be done while keeping certain distance from a radio, computer and stereo equipment.
 - Especially, keep the unit at least 3m away from the electrical equipment in an area with weak electromagnetic waves and put the main power cable and communication cables in a separately installed protection tube.
 - Make sure that there is no equipment that generates electromagnetic waves. If not electromagnetic waves may cause problem to the control systems which may lead to air conditioner malfunction. (Example: Remote control sensor of the indoor unit may not receive the signal very well, due to ballast stabilizer of the lighting equipment.)
- In regions with heavy snowfall, make sure to install the outdoor unit where there is no concerns of direct snowfall on the outdoor unit. Also, build higher base support so that accumulated snow does not block the air inlet or the heat exchanger.
- R-410A refrigerant is a safe, nontoxic and nonflammable refrigerant. However, if the place holds any concerns for exceeding dangerous level of refrigerant concentration in case of refrigerant leakage, extra ventilation system is required.

10. Installation

Outdoor unit

- When you install the outdoor unit in high places such as a roof, install fence or guardrail around it. When there is no fence or guardrail, service person could fall.
- Do not install the product in places where corrosive gases such as sulfur oxides, ammonia, and sulfur dioxide are produced. (e.g. Toilet outlet, ventilation opening, sewage works, dyeing complex, cattle shed, sulfuric hot spring, nuclear power plant, ship etc.) When installing the product in those places, contact an installation specialty store as the copper pipe and brazing part will need additional corrosion proof or anti-rust additive to prevent corrosion.
- Make sure not to keep any inflammable materials (such as wooden materials, oil etc.) around the outdoor unit. When there's fire, those inflammable material will easily catch the fire and may pass it on to the product.
- Depending on the condition of power supply, unstable power or voltage may cause malfunction of the parts or control system. (At the ship or places using power supply from electric generator...etc)
- Make sure to install MCU when using HR products.
- When you select the location to install the MCU, the location is far away from indoor rooms because the refrigerant running of MCU may create noise.

Outdoor unit space requirements

- Space requirement was decided based on following conditions; Cooling mode, outdoor temperature of 35 °C. Larger space is required if the outdoor temperature is higher than 35 °C or if the place is heated easily by quantity of solar radiation.
- When you secure installation space, consider path for people and the direction of the wind.
- Secure installation space as shown in the below illustration, considering ventilation and the service space.
- If the installation space is narrow, installer or other worker may get injured during work and may also cause problem to the product.
- If you install multiple number of outdoor units in one space, make sure to secure enough ventilation space if there's any walls around the product that may disturb the air flow. If enough ventilation space is not secured, product may malfunction.
- You may install the outdoor units with 20mm of space between the product, but product's performance may decrease depending on the installation environment.

Single installation

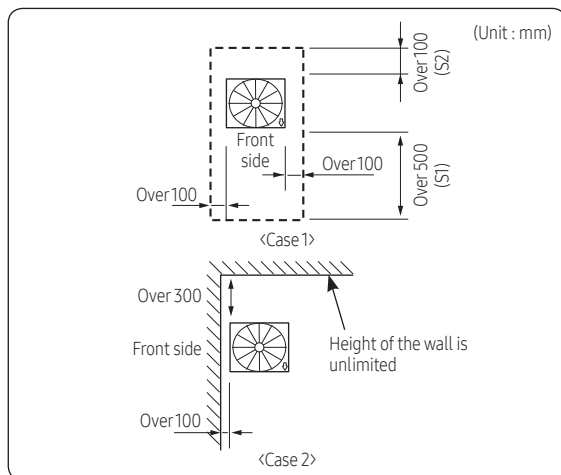

Module installation

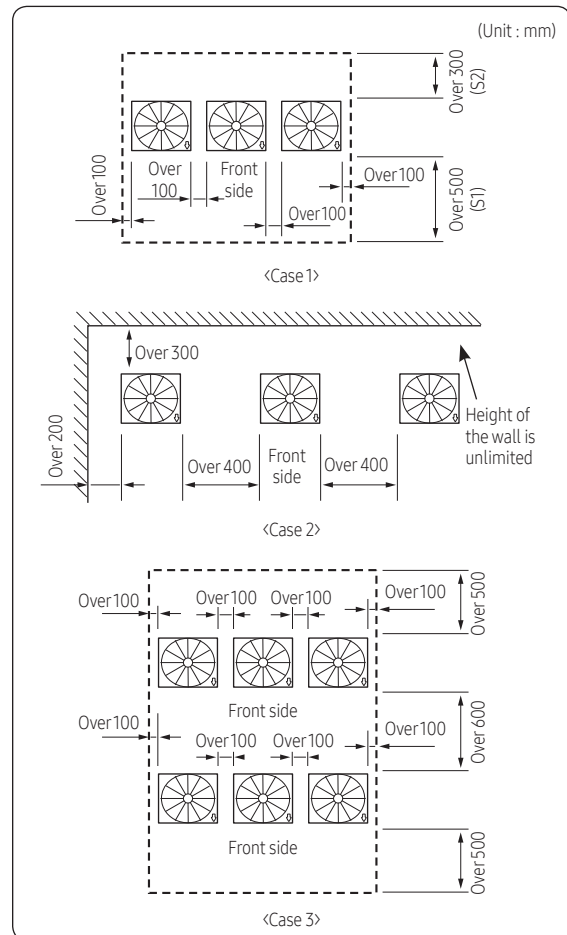

- For <Case 1> or <Case 3>
 - Height of the wall on the front side should not be higher than 1500mm.
 - Height of the wall on the air inlet side should not be higher than 500mm.
 - Height of the wall on the side is not limited.
 - If the height of the wall exceeds by certain value (h_1 , h_2), additional clearance $[(h_1)/2, (h_2)/2$: Half of the exceeded height] should be added to the service space (S_1 , S_2).

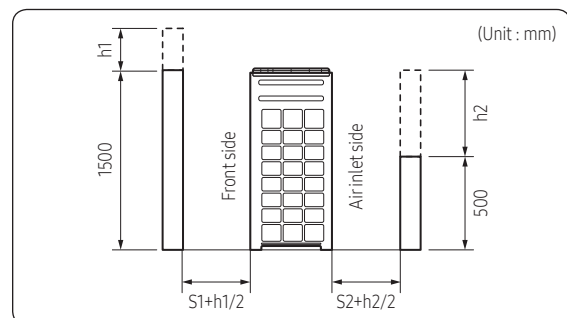

10. Installation

Outdoor unit

Preparing materials and tools

- You must keep the installation manual until the installation is finished.
- Hand over the installation manual to the customer after finishing the installation.

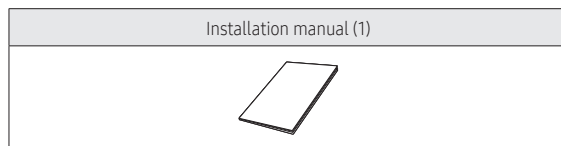

Optional accessories

- Following optional accessories are needed for connecting pipes between the indoor and outdoor units.

Classification	Model Name	Specification
Y-Joint	MXJ-YA1509M	15.0 kW and below
	MXJ-YA2512M	15.1 kW ~ 40.0 kW
	MXJ-YA2812M	40.1 kW ~ 45.0 kW
	MXJ-YA2815M	45.1 kW ~ 70.3 kW
	MXJ-YA3419M	70.4 kW ~ 98.4 kW
	MXJ-YA4119M	98.5 kW ~ 135.2 kW
	MXJ-YA4422M	Over 135.2 kW

Classification	Model Name	Specification
Y-Joint (Only H/R)	MXJ-YA1500M	22.4 kW and below
	MXJ-YA2500M	22.5 kW ~ 70.3 kW
	MXJ-YA3100M	70.4 kW ~ 135.2 kW
	MXJ-YA3800M	Over 135.2 kW
Distribution header	MXJ-HA2512M	45.0 kW and below (for 4 rooms)
	MXJ-HA3115M	70.3 kW and below (for 8 rooms)
	MXJ-HA3819M	70.4 kW ~ 135.2 kW (for 8 rooms)
Y-Joint - Outdoor unit	MXJ-TA3419M	135.2 kW and below
	MXJ-TA4122M	Over 135.2 kW
Y-Joint (Only H/R) - Outdoor unit	MXJ-TA3100M	135.2 kW and below
	MXJ-TA3800M	Over 135.2 kW

- ※ If you use an indoor unit with no internal EEV(Electric Expansion Valve), you will need an EEV kit.
- ※ Only use the genuine accessories listed in above table and do not use imitated accessories.

Outdoor unit installation

WARNING

- Make sure to remove the wooden pallet before installing the outdoor unit. If you do not remove the wooden pallet, there is risk of fire during welding the pipes. If the outdoor unit is installed with wooden pallet on, and it was used for long period time, wooden palette may break and cause electrical hazard or high pressure may damage the pipes.
- ※ Fix an outdoor unit firmly on the base ground with anchor bolts.
- ※ Manufacturer is not responsible for the damage occurred by not following the installation standards.
- 1 Make sure that the height of the base ground is 200mm or higher to protect the outdoor unit from rain water or other external conditions. Also, install a draining pit around the base ground and connect the drain pipe to the drainage.
- 2 Considering the vibration and weight of the outdoor unit, strength of the base ground must be strong to prevent noise and the top surface of it should be flat.
- 3 Base ground should be 1.5 times larger than the bottom of the outdoor unit.
- 4 Outdoor unit must be fixed firmly so that it can withstand the wind speed of 30m/s. If you cannot fix the outdoor unit on the base ground, fix it by side or use extra structure.
- 5 In heating operation, defrost water may form so you must really care about the drainage and waterproofing the floor. To prevent defrost water from stagnating or freezing, construct a drainage with over 1/50 slope. (Ice may form on the floor in winter season.)
- 6 It is necessary to add wire mesh or steel bar during concrete construction for the base ground to prevent damages or cracks.
- 7 When installing multiple outdoor units at the same place, construct an H beam or an anti-vibration frame on the base ground to install the outdoor unit.
- 8 After installing an H beam or an anti-vibration frame, apply corrosion protection and other necessary coating.
- 9 When concrete construction for outdoor unit installation is completed, install an anti-vibration pad (t=20mm or more) or an anti-vibration frame to prevent vibration of the outdoor unit from transferring to the base ground.
- 10 Place the outdoor unit on an H beam or an anti-vibration frame and fix it with the bolt, nut and washer. (The bearing force has to be over 3.5kN)

10. Installation

Outdoor unit

⚠ CAUTION

- Cautions regarding on connecting the anchor bolt
 - Tighten the rubber washer to prevent the bolt connection part of the outdoor unit from corroding.



- Anchor specification

Size	Diameter of drill bit (a)	Anchor length (b)	Sleeve length (c)	Insert depth	Fastening torque
Ø10	14 mm	75 mm	40 mm	50 mm	30 N·m

- ※ Use the anchor bolts and nuts that is zinc plated or made of STS material. Regular anchor bolts or nuts may get damaged by corrosion.

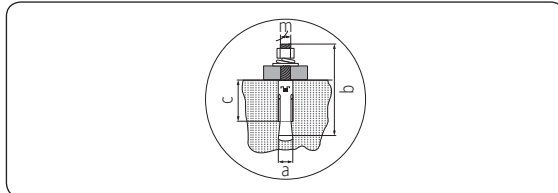

- Cautions regarding on connecting the pipe
 - If you install the outdoor unit on the rooftop, check the strength and make sure to waterproof the rooftop.
 - Construct draining pit around the base construction and pay attention to the drainage around the outdoor unit. (Condensation or defrost water may form during outdoor unit operation.)
 - If there's any possibility of small animals from entering the pipe outlet, block the outlet as shown in the illustration.

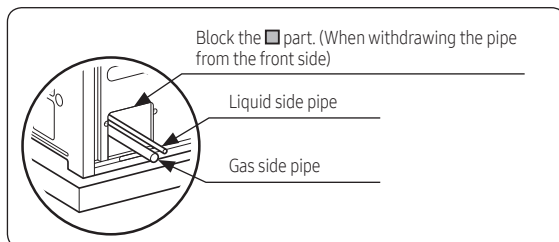

- Cautions regarding on anti-vibration frame installation
 - During installation, make sure there is no gap between the base ground and the supporting structures such as anti-vibration frame or H beam.
 - Base ground must be constructed strongly to support the bottom part of the anti-vibration mount.

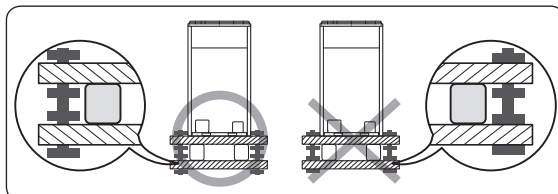

- After installing the anti-vibration frame, untighten the fixing part on the top and bottom part of the frame.

- Caution for installing discharge duct
 - Static pressure of the discharge duct should be within the standard specification when installing the duct.
 - If you remove the fan guard to install the discharge duct, make sure to install a safety net on the duct outlet. Foreign substance may enter into the product and there could be a risk of personal injury.
 - Wear protection equipment at all times when making galvanized sheet metal duct, since the worker may get injured by the sharp parts.
 - When installing the outdoor unit under the tree or near forest, leaves may get into the product and cause problems on the product. Therefore, install a discharge duct to prevent foreign substance infiltration.



Installing the outdoor unit in various environments

Installing the outdoor unit around the obstacles

- It is necessary to install a discharge guide duct(field supply) to direct exhaust from the fan horizontally, when it is difficult to provide a minimum space of 2m between the air outlet and a nearby obstacle.

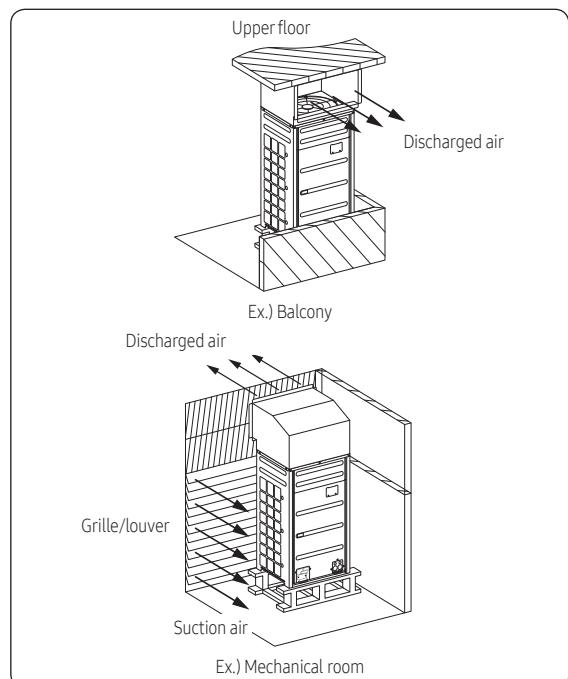

10. Installation

Outdoor unit

⚠ WARNING

- Should adopt bar type louver. Don't use a type of rain resistance louver.

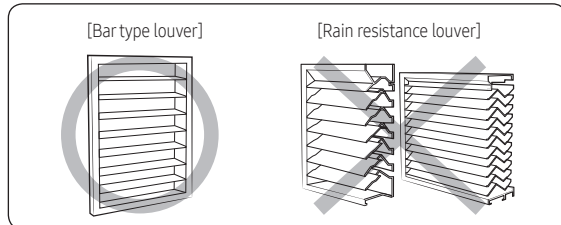

- Louver specifications.
 - Angle criteria : less than 20°
 - Opening ratio criteria : greater than 80%

Installing the outdoor unit in cold region

- In cold regions with lots of snowfall, install a snow prevention duct, as a sufficient countermeasure, to prevent snow from accumulating on the outdoor unit. When the snow prevention duct is not installed, frost may accumulate on the heat exchanger and heating operation may not work normally.
- Air outlet of the duct should not be directed to the enclosed space.

⚠ CAUTION

- Cautions regarding on installing the frame and selecting the base ground
 - Height (h) of the frame and the base ground should be higher than the "heaviest expected snowfall".
 - Area of the frame and the base ground should not be larger than the area of the outdoor unit. Snow may accumulate if the area of the frame or the base ground is larger.

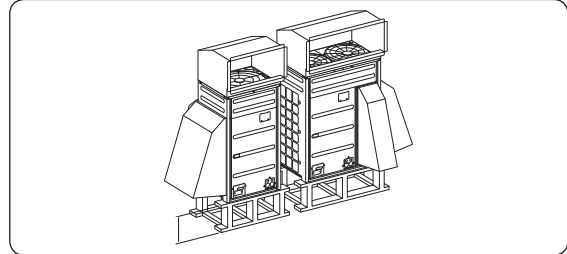

Installing the outdoor unit in windy region

- In windy regions such as near sea shores, protection wall or wind protection duct must be installed for normal operation of the outdoor unit. (Refer to the illustration of the snow prevention duct, for installing the wind protection duct.)
- Install the wind prevention duct with the consideration of major wind direction. If the direction of the discharge part is same as major direction of the wind, it could cause product's performance decrease.

⚠ CAUTION

- Cautions regarding on installing the frame and selecting the base ground
 - The base ground must be solid and the outdoor unit must be fixed with anchor bolts.
 - Make sure to install outdoor unit in a place strong enough to withstand its weight. If the place cannot withstand the weight of the outdoor unit, outdoor unit may fall and cause personal injury.
 - When installing on a rooftop subject to strong wind, countermeasures must be taken to prevent the unit from falling down.
 - Use a frame that is resistant to corrosion.

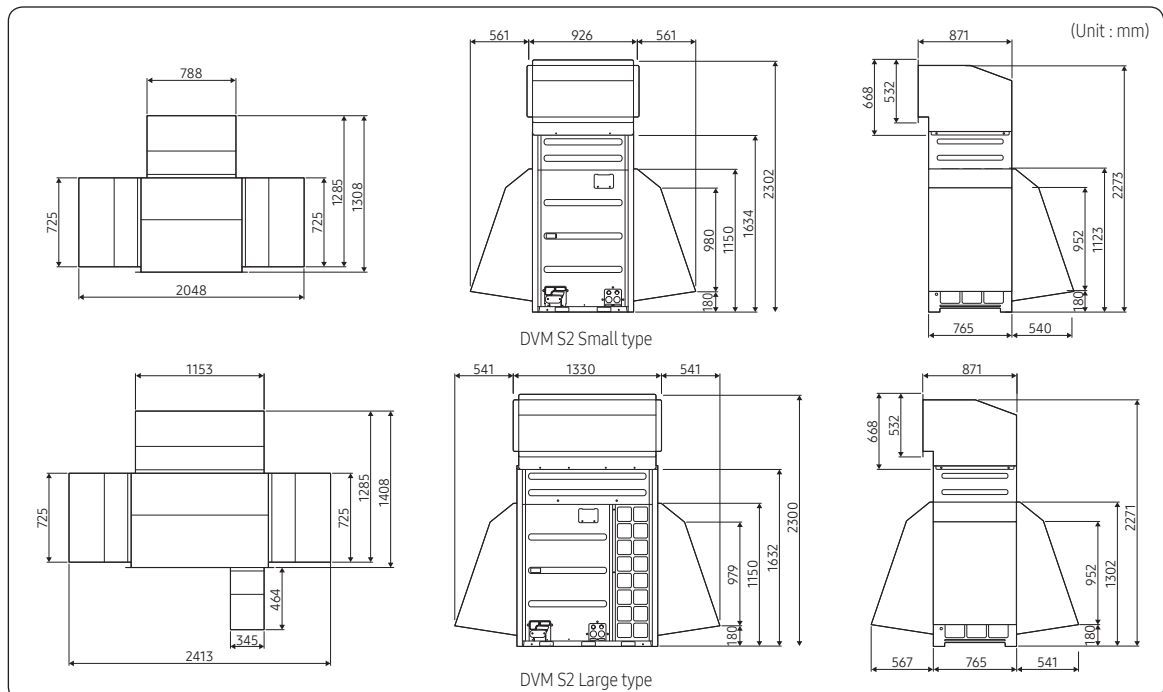

10. Installation

Outdoor unit

WARNING

- When installing, make sure there is no leakage. When collecting the refrigerant, stop the compressor first before removing the connection pipe. If the refrigerant pipe is not properly connected and the compressor works with the service valve open, the pipe inhales the air and it makes the pressure inside of the refrigerant cycle abnormally high which may lead to explosion and injury.

Refrigerant pipe work

- The length of refrigerant pipe should be as short as possible and the height difference between an indoor and outdoor unit should be minimized.
- Piping work must be done within allowable piping length, height difference, and the allowable length after branching.
- The pressure of the R-410A is high. Use only certified refrigerant pipe and follow the installation method.
- After installing the pipes, calculate the total length of the pipe to check if additional refrigerant is needed. When you need to charge the additional refrigerant, make sure to use R-410A refrigerant.
- Use clean refrigerant pipe and there shouldn't be any harmful ion, oxide, dust, iron content or moisture inside pipe.
- Use tools and accessories that fit on R-410A only.

Tool	Installation process/ purpose	Compatibility with conventional tool
Pipe cutter	Refrigerant pipe installation	Pipe cutting
Flaring tool		Pipe flaring
Refrigerant machine oil	Air tightness test	Apply refrigerant oil on flared part
Torque wrench		Connect flare nut with pipe
Pipe bender		Pipe bending
Nitrogen gas	Air tightness test	Prevent oxidation within the pipe
Welder		Pipe welding
Manifold gauge	Air tightness test ~ additional refrigerant charging	Vacuuming, charging refrigerant and checking operation
Refrigerant charging hose		Need exclusive one since there is risk of refrigerant leakage or inflow of impurities

Tool	Installation process/ purpose	Compatibility with conventional tool
Vacuum pump	Pipe drying	Compatible (Use products which contain the check valve to prevent the oil from flowing backward into the outdoor unit.) Use the one that can be vacuumed up to -100.7kpa(5Torr).
Scale for refrigerant charging	Refrigerant charging	Compatible
Gas leak detector	Gas leak test	Need exclusive one (Ones used for R-134a is compatible)
Flare nut	Must use the flare nut equipped with the product.	

Selecting refrigerant pipe

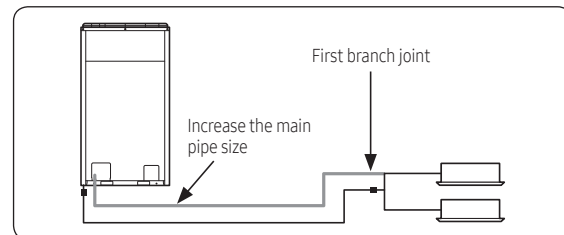

- Install the refrigerant pipe according to main pipe size of each outdoor unit capacity.
- When the pipe length (including elbow) between an outdoor unit and the farthest indoor unit exceeds 90m, you must increase the size of the pipe (main pipe) by one grade which connects between the outdoor unit to the first branch joint.
- For H/R model, When the pipe length (including elbow) between an outdoor unit and the farthest indoor unit exceeds 90m, you must increase the size of the liquid pipe by one grade among the pipes(main pipe) which connects between the outdoor unit to the first branch joint.

10. Installation

Outdoor unit

○ (A)
■ (B)

Ex.) 135.2 kW

Capacity (kW)	No.	Pipe size (mm)	
		Liquid	Gas
33.6	(1)	Ø 12.70	Ø 28.58
73.6	(2)	Ø 19.05	Ø 34.92
135.2	(3)	Ø 19.05	Ø 41.28

Size of the pipe connected to the outdoor unit (A)

Select the size of the main pipe according to the below table.

Outdoor unit capacity (kW) (Cooling)	*Maximum pipe length within 90m		*Maximum pipe length over 90m		
	Liquid (mm)	Gas (mm)	Liquid (mm)	Gas (mm)	
Capacity ≤ 25	Ø 9.52	Ø 19.05	Ø 12.70	Ø 22.22	
25 < Capacity ≤ 32		Ø 22.22		Ø 25.40 ^{note1)}	
32 < Capacity ≤ 39	Ø 12.70	Ø 28.58	Ø 15.88	Ø 28.58	
39 < Capacity ≤ 44				Ø 19.05	Ø 31.75 ^{note2)}
44 < Capacity ≤ 48					Ø 38.10 ^{note3)}
48 < Capacity ≤ 55	Ø 15.88	Ø 34.92	Ø 22.22	Ø 41.28	
55 < Capacity ≤ 66				Ø 41.28	Ø 53.98
66 < Capacity ≤ 72	Ø 19.05	Ø 53.98	Ø 25.40 ^{note1)}	Ø 53.98	
72 < Capacity ≤ 100				Ø 22.22	Ø 28.58
100 < Capacity ≤ 139	Ø 22.22	Ø 25.40	Ø 28.58	Ø 28.58	
139 < Capacity ≤ 173				Ø 25.40	Ø 28.58
173 < Capacity ≤ 252	Ø 25.40	Ø 28.58	Ø 28.58	Ø 28.58	
252 < Capacity	Ø 25.40	Ø 28.58	Ø 28.58	Ø 28.58	

*Maximum pipe length : The pipe length between an outdoor unit and the farthest indoor unit.
 Note1) If Ø 25.40 pipe is not available on site, use Ø 28.58 pipe.
 Note2) If Ø 31.75 pipe is not available on site, use Ø 34.92 pipe.
 Note3) If Ø 38.10 pipe is not available on site, use Ø 41.28 pipe.
 ※ For the case that the diameter of the default pipe of an outdoor unit does not match that of the pipe installed on the site, a socket is provided by default together with the outdoor unit.

Size of the pipe between the branch joint and the indoor unit

Make a selection according to outdoor unit capacity.

Indoor unit capacity (kW)	Pipe size (O.D. mm)	
	Liquid	Gas
6.0 and below	Ø 6.35	Ø 12.70
6.1 ~ 16.0	Ø 9.52	Ø 15.88
16.1 ~ 23.0	Ø 9.52	Ø 19.05
Over 23.0	Ø 9.52	Ø 22.22

Branch joint

Branch joint between outdoor units (C)

Classification	Model name	Specification (kW)
Y-joint for outdoor unit (C)	MXJ-TA3419M	135.2 and below
	MXJ-TA4122M	Over 135.2

First branch joint (D)
 Make a selection according to outdoor unit capacity.

Classification	Model name of the branch joint	Outdoor unit capacity (kW)
Y-joint (D)	MXJ-YA1509M	15.0 and below
	MXJ-YA2512M	15.1 ~ 40.0
	MXJ-YA2812M	40.1 ~ 45.0
	MXJ-YA2815M	45.1 ~ 70.3
	MXJ-YA3419M	70.4 ~ 98.4
	MXJ-YA4119M	98.5 ~ 135.2
	MXJ-YA4422M	Over 135.2

Branch joint (E)
 Select a branch joint according to the sum of indoor unit capacity which will be connected after the branch.
 ※ However, if the size of the pipe between branch joints (E) is bigger than the size of the pipe connected to the outdoor unit (D), apply the pipe size (D).

1) Y-joint

Classification	Model name	Specification (kW)
Y-joint (E)	MXJ-YA1509M	15.0 and below
	MXJ-YA2512M	15.1 ~ 40.0
	MXJ-YA2812M	40.1 ~ 45.0
	MXJ-YA2815M	45.1 ~ 70.3
	MXJ-YA3419M	70.4 ~ 98.4
	MXJ-YA4119M	98.5 ~ 135.2
	MXJ-YA4422M	Over 135.2

2) Distribution header

Classification	Model name	Specification (kW)
Distribution header (E)	MXJ-HA2512M	45.0 and below (for 4 rooms)
	MXJ-HA3115M	70.3 and below (for 8 rooms)
	MXJ-HA3819M	70.4 ~ 135.2

Size of the pipe between branch joints (B)

Select the pipe size according to the sum of indoor unit capacity which will be connected after the branch.
 ※ However, if the size of the pipe between branch joints (B) is bigger than the size of the pipe connected to the outdoor unit (A), apply the pipe size (A).

Indoor unit capacity (kW)	Branch pipe length within 45m		Branch pipe length between 45~90m		
	Liquid (mm)	Gas (mm)	Liquid (mm)	Gas (mm)	
Capacity ≤ 15	Ø 9.52	Ø 15.88	Ø 12.70	Ø 19.05	
15 < Capacity ≤ 25		Ø 19.05		Ø 22.22	
25 < Capacity ≤ 32		Ø 22.22		Ø 25.40 ^{note1)}	
32 < Capacity ≤ 39	Ø 12.70	Ø 28.58	Ø 15.88	Ø 28.58	
39 < Capacity ≤ 44				Ø 19.05	Ø 31.75 ^{note2)}
44 < Capacity ≤ 48					Ø 38.10 ^{note3)}
48 < Capacity ≤ 55	Ø 15.88	Ø 34.92	Ø 22.22	Ø 41.28	
55 < Capacity ≤ 66				Ø 41.28	Ø 53.98
66 < Capacity ≤ 72	Ø 19.05	Ø 53.98	Ø 25.40 ^{note1)}	Ø 53.98	
72 < Capacity ≤ 100				Ø 22.22	Ø 28.58
100 < Capacity ≤ 139	Ø 22.22	Ø 25.40	Ø 28.58	Ø 28.58	
139 < Capacity ≤ 173				Ø 25.40	Ø 28.58
173 < Capacity ≤ 252	Ø 25.40	Ø 28.58	Ø 28.58	Ø 28.58	
252 < Capacity	Ø 25.40	Ø 28.58	Ø 28.58	Ø 28.58	

Note1) If Ø 25.40 pipe is not available on site, use Ø 28.58 pipe.
 Note2) If Ø 31.75 pipe is not available on site, use Ø 34.92 pipe.
 Note3) If Ø 38.10 pipe is not available on site, use Ø 41.28 pipe.

10. Installation

Outdoor unit

When all the following conditions are met, install the main liquid pipe that is one step smaller to reduce piping load and the amount of refrigerant.

Note that the refrigerant for the main liquid pipe must be added by the specified amount upon reduction.

Condition 1: In case the length for vertical piping is less than 40 m

Condition 2: Max. length A \geq Max. piping length / {1 - (vertical piping length * 0.015)}

※ Max. piping length: Piping length between the outdoor unit and the farthest indoor unit (m)

- Length allowed to reduce the diameter of liquid pipe, A (equivalent length)
- When piping is installed with reduction of the diameter of liquid pipe, Please set option 'reduction of the diameter of liquid pipe.'

Capacity (HP)	Below 90 m		Over 90m		Capacity (HP)	Below 90 m		Over 90m	
	Pipe diameter	Max. length (m)	Pipe diameter	Max. length (m)		Pipe diameter	Max. length (m)	Pipe diameter	Max. length (m)
8	This capacity is not supported.				54	15.88	40	19.05	130
10	This capacity is not supported.				56	15.88	40	19.05	120
12	9.52	50	12.7	200	58	15.88	40	19.05	120
14	9.52	40	12.7	190	60	15.88	40	19.05	110
16	9.52	30	12.7	150	62	19.05	90	22.22	200
18	12.7	90	15.88	200	64	19.05	90	22.22	200
20	12.7	90	15.88	200	66	19.05	90	22.22	200
22	12.7	80	15.88	200	68	19.05	90	22.22	200
24	12.7	70	15.88	200	70	19.05	80	22.22	190
26	15.88	90	19.05	200	72	19.05	80	22.22	180
28	15.88	90	19.05	200	74	19.05	70	22.22	170
30	15.88	90	19.05	200	76	19.05	70	22.22	160
32	15.88	90	19.05	200	78	19.05	70	22.22	150
34	15.88	90	19.05	200	80	19.05	60	22.22	150
36	15.88	90	19.05	200	82	19.05	60	22.22	140
38	15.88	90	19.05	200	84	19.05	60	22.22	130
40	15.88	80	19.05	200	86	19.05	50	22.22	130
42	15.88	70	19.05	200	88	19.05	50	22.22	120
44	15.88	70	19.05	200	90	19.05	50	22.22	120
46	15.88	60	19.05	180	92	This capacity is not supported.			
48	15.88	60	19.05	170	94	This capacity is not supported.			
50	15.88	50	19.05	150	96	This capacity is not supported.			
52	15.88	50	19.05	140	98	This capacity is not supported.			

e.g. In case of the site for 20HP, Max. piping length of 140 m (Horizontal piping length of 120 m & Vertical piping length of 20 m):

Max. length A \geq Max. piping length / {1 - (Vertical piping length * 0.015)}

$200 \text{ m} \geq 140 \text{ m} / \{1 - (20 * 0.015)\} = 140 \text{ m} / 0.7 = 200 \text{ m}$

Thus, the Max. piping length of 140 m (Horizontal piping length of 120 m & Vertical piping length of 20 m) can be allowed.

Accordingly, horizontal piping of 120 m + vertical piping of 20 m (140 m in total) can be installed.

10. Installation

Outdoor unit

Additional refrigerant

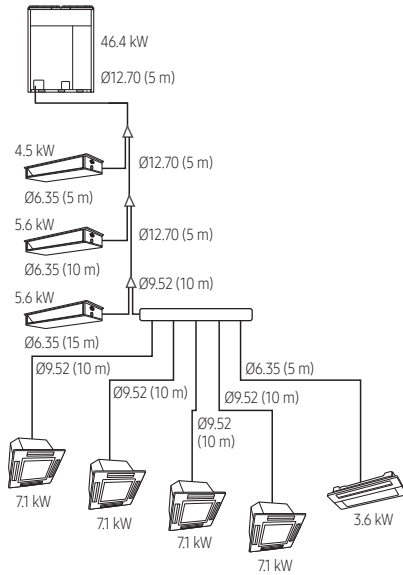

Refrigerant pipe installation

- Basic amount of refrigerant within the outdoor unit (kg)
 - Amount of additional refrigerant has to be calculated based on the sum of all liquid pipe length.

Classification	AM080AXVGGH/EU	AM100AXVGGH/EU	AM120AXVGGH/EU	AM140AXVGGH/EU	AM160AXVGGH/EU	AM180AXVGGH/EU
Basic amount	7.0	7.0	7.0	8.0	10.5	10.5
Classification	AM200AXVGGH/EU	AM220AXVGGH/EU	AM240AXVGGH/EU	AM260AXVGGH/EU		
Basic amount	10.5	10.5	14	14		
Classification	AM080AXVAGH/EU	AM100AXVAGH/EU	AM120AXVAGH/EU	AM140AXVAGH/EU	AM160AXVAGH/EU	AM180AXVAGH/EU
Basic amount	5.5	5.5	7.0	7.0	8.0	8.0
Classification	AM200AXVAGH/EU	AM220AXVAGH/EU	AM240AXVAGH/EU	AM260AXVAGH/EU		
Basic amount	10.5	10.5	14.0	14.0		

- Amount of additional refrigerant depending on the pipe size ()
 - Amount of additional refrigerant has to be calculated based on the sum of all liquid pipe length.

Size of liquid pipe	Ø 6.35	Ø 9.52	Ø 12.70	Ø 15.88	Ø 19.05	Ø 22.22	Ø 25.40	Ø 28.58
Additional amount (kg/m)	0.02	0.06	0.125	0.18	0.27	0.35	0.53	0.65
Amount of refrigerant added when the diameter of liquid pipe is reduced (kg/m)	-	0.08	0.13	0.195	0.28	0.42	0.53	-

- For the indoor unit already connected to EEV kit, the additional refrigerant charging is 0.01kg per meter regardless of the pipe size.

10. Installation

Outdoor unit

- Amount of additional refrigerant for each indoor unit (b)

(Unit: kg)

Model	Refrigerant Amount (kg /Unit)																												
	1.5	1.7	2.2	2.8	3.2	3.6	4.0	4.5	5.6	6.0	7.1	8.2	9.0	9.3	11.0	11.2	12.8	14.0	16.0	18.0	22.0	22.4	25.0	28.0	32.0	50.0	500CMH	1000CMH	
Interior 1way cassette (JSF-0) (AM***HN1DEH/**) (AM***NN1PEH/**)		0.15	0.15																										
Slim 1way cassette (JSF-1/JSF-2) (AM***F(J/N)N1DEH/**)			0.25	0.25		0.25			0.32	0.32																			
2way cassette (AM***N2DEH/**)									0.31	0.47																			
4way cassette S(600x600) (AM***NND4DEH/**)	0.29		0.29	0.29		0.29		0.37	0.37	0.37																			
4way cassette S (AM***F(N)N4DEH/**)								0.45	0.45	0.45		0.45				0.57	0.69	0.69											
4way cassette S (AM***N4FEH/**)				0.69		0.69	0.69		1.00	1.00	1.00	1.00	1.00		1.00														
360 cassette (AM***KN4DEH/**)								0.45	0.45	0.45		0.45				0.69	0.69	0.69											
Duct S (AM***NMPKH/**)						0.22		0.22	0.22	0.22		0.31				0.38	0.38	0.38											
Duct S (AM***NMPKH9/**)					0.31	0.31		0.38	0.38	0.38																			
Duct S (AM***HNPKH/**)																0.38	0.38	0.38											
Home Duct (AM***KNLDEH/**)		0.13	0.13	0.13		0.17																							
Home Duct (AM***MNLDEH/**)								0.24	0.24	0.31																			
Slim duct (AM***FNLDEH/**)		0.17	0.17	0.17		0.26		0.35	0.35	0.45		0.42				0.42	0.62	0.62											
Slim duct (with drain pump) (AM***KNLDEH/**)								0.35	0.35	0.45		0.42				0.42	0.62	0.62											
Slim duct (AM***FNLFP(EH/**)				0.62		0.45	0.45		0.62	0.62						0.62													
Slim duct (AM***NLF(EH/**)						0.62	0.62																						
MSP duct (AM***NMDEH/**)			0.24	0.24		0.24		0.28	0.28	0.28		0.32				0.54	0.68	0.68	0.91										
HSP duct (AM***NHDEH/**)																0.68	0.68	0.68			1.18					1.18			
HSP duct (AM***NHF(P)EH/**)							1.18			1.18	1.18	1.18	1.18		1.18														
Big duct (AM***JNHF(P)KH/**)																					1.15		1.15						
OAP duct (AM***NEPEH/**)																			0.68			1.18				1.18			
Concealed Floor Standing (AM***NFDEH/**)						0.22			0.32	0.32																			
Floor Standing (AM***NPDKH/**)																		0.69								1.85			
Ceiling (AM***NCDEH/**) (AM***NCCKH/**)									0.39	0.39					0.56		0.95												
Console (AM***NJDEH/**)			0.16	0.27		0.27		0.27	0.27																				
Wall mounted (Neo forte) (AM***F(H)NTDEH/**)	0.24		0.24	0.24		0.24			0.36	0.36																			
Wall mounted (Neo forte with EEV) (AM***F(H)NQDEH/**)	0.34		0.34	0.34		0.34		0.51	0.51	0.51																			
Wall mounted (AR5000) (AM***NADKH/**)	0.16		0.16	0.19		0.25		0.25	0.52	0.52	0.52																		
Wall mounted (AR5000 with EEV) (AM***NVDE(K)H/**)	0.22		0.22	0.25		0.34		0.34	0.71	0.71	0.71																		
Wall mounted (Boracay) (AM***KNTDEH/**)	0.24		0.24	0.32		0.32		0.49	0.49	0.49																			
Wall mounted (Boracay with EEV) (AM***KNQDEH/**)	0.24		0.24	0.32		0.32		0.49	0.49	0.49																			
Wall mounted (MAX4 with EEV) (AM***MNQDEH/**)														0.68															
ERV plus (AM***NKDEH/**)																											0.11	0.36	
Hydro Unit HE (AM***NBDEH/**)																			0.60							0.70	1.20		
Hydro Unit HT (AM***NBF(B/**)																													
MCU (MCU-S*NE**N)																													
4Way CST (AM***ANMPKH/**)				0.45		0.45		0.45	0.60	0.60	0.60	0.73				0.73	0.88	0.88											
LSP Duct (AM***ANLDKH/**)		0.13	0.13	0.13		0.17		0.24	0.24	0.31																			
MSP Duct (Duct S) (AM***ANMPKH/**)				0.45	0.45		0.45		0.45	0.45	0.45	0.80				0.84	0.84	0.84											
HSP Duct (Duct S) (AM***ANHPKH/**)									0.80	0.80	0.80	0.84				0.84	0.84	0.84											
A3050 (AM***JNADKH/**)	0.16		0.16	0.19		0.25		0.25	0.52	0.52	0.52																		
A3050 (with EEV) (AM***JNVDKH/**)	0.22		0.22	0.25		0.34		0.34	0.71	0.71	0.71																		
QMD RAC (AM***TNADKH/**) (AM***TNVDKH/**) (AE***TNXDEG/**)	0.23		0.23	0.32		0.32		0.48	0.48	0.48	0.64																		

※ If there is no additional refrigerant value for the indoor unit in the above table, refer to the indoor unit installation manual.

10. Installation

Outdoor unit

- If AHU kit is included among the indoor units, you must add 0.063kg of refrigerant for every 1kW of the AHU capacity increase.
Note1) In case the capacity conjunction of the Hydro Unit HT exceeds 50 % among the total indoor unit, please don't put the additional refrigerant.
- Method to calculate total amount of additional refrigerant
 - Amount of additional refrigerant depending on the pipe length (a)
 - Amount of additional refrigerant for each indoor unit (b) = Σ (Amount of additional refrigerant for each connected indoor unit) × Refer to the table
 - Total amount of additional refrigerant = a+b
- × Sum of total amount of additional refrigerant and the basic amount of refrigerant should not exceed 100kg. If the refrigerant exceeds 100kg, separate the module so that weight of the refrigerant doesn't exceed 100kg.
Ex> If the outdoor unit's basic refrigerant amount is 10.5kg, the total amount of additional refrigerant(a+b) should not exceed 89.5kg.
- Example of refrigerant calculation for HP models

Classification	Size of liquid pipe	Length (m)	Unit amount of refrigerant (kg/m)	Amount of additional refrigerant (kg)	Total amount of additional refrigerant (kg)
		①	②	①×②	Σ (①×②)
Liquid pipe (a)	Ø 6.35	35	0.02	0.7	a) 5.575
	Ø 9.52	50	0.06	3.0	
	Ø 12.70	15	0.125	1.875	

Classification	Model name of indoor unit	Number of units	Unit amount of refrigerant (kg/EA)	Amount of additional refrigerant (kg)	Total amount of additional refrigerant (kg)
		①	②	①×②	Σ (①×②)
Indoor unit (b)	4way cassette (AM071FN4DEH*)	4	0.45	1.80	b) 3.10
	Slim duct (AM056FNLDEH*)	2	0.35	0.70	
	Slim duct (AM045FNLDEH*)	1	0.35	0.35	
	1way cassette (AM036FN1DEH*)	1	0.25	0.25	

– Total amount of refrigerant (a+b) = 5.575+3.10 = 8.675 (kg)

- Example of refrigerant calculation for HR models

Classification	Size of liquid pipe	Length (m)	Unit amount of refrigerant (kg/m)	Amount of additional refrigerant (kg)	Total amount of additional refrigerant (kg)
		①	②	①×②	Σ (①×②)
Liquid pipe (a)	Ø 6.35	15	0.02	0.3	a) 11.965
	Ø 9.52	112	0.06	6.72	
	Ø 12.70	25	0.125	3.125	
	Ø 15.88	10	0.18	1.8	
	Ø 6.35 (EEV Kit ~ indoor unit)	2	0.01	0.02	

Classification	Model name of indoor unit	Number of units	Unit amount of refrigerant (kg/EA)	Amount of additional refrigerant (kg)	Total amount of additional refrigerant (kg)
		①	②	①×②	Σ (①×②)
Indoor unit (b)	4way cassette (AM071FN4DEH*)	5	0.45	2.25	b) 4.66
	4way cassette (AM112FN4DEH*)	2	0.57	1.14	
	Neo forte (AM028FNTDEH*)	1	0.27	0.27	
	MCU	2	0.5	1	

– Total amount of refrigerant (a+b) = 11.965+4.66 = 16.625 (kg)

10. Installation

Outdoor unit

Pipe installation for an outdoor unit

1 Direction of the pipe

Refrigerant pipe can be withdrawn from the front, left and right side. Take necessary method to install the pipes according to the condition of the installation site.

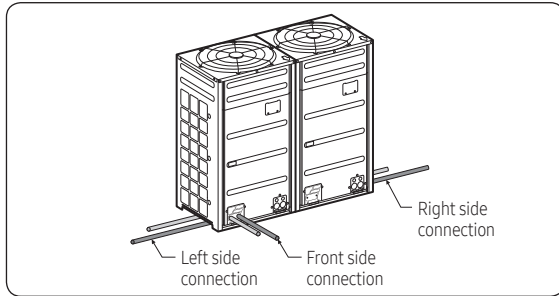

⚠ CAUTION

- Caution for using knock-out hole

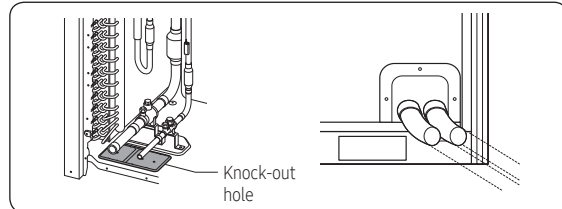

- Make sure to prevent any damages on the exterior of the outdoor unit.
- Remove all burrs around the knock-out hole and apply varnish on the cross section and edges of the knock-out hole to prevent rust.
- Use a cable protection tube and bushing to prevent a cable from being damaged when passing through a knock-out hole.

1 Connecting refrigerant pipe for outdoor unit

Classification	Front side connection	Right/left (and bottom) side connection
Working process	<ul style="list-style-type: none"> • First, remove the piping cover from the outdoor unit. • Separate the knock-out hole that you are going to use. If you separate the knock-out hole that is going to be unused, small animals such as squirrels and rats may get into the unit through the hole. • Fix the bottom side of the piping cover first and then fix the top part of it. 	<ul style="list-style-type: none"> • Separate the knock-out hole at the bottom side of the unit and install the pipe. • After installing and insulating the pipe, close up the remaining holes. If not, small animals such as rats and squirrels may get inside the unit.
H/P	<p>Gas side pipe</p> <p>Liquid side pipe</p>	<p>Gas side pipe</p> <p>Liquid side pipe</p>
H/R	<p>High pressure gas pipe</p> <p>Low pressure gas pipe</p> <p>Liquid side pipe</p>	<p>High pressure gas pipe</p> <p>Low pressure gas pipe</p> <p>Liquid side pipe</p>

⚠ CAUTION

- Caution for welding the pipe to an outdoor unit
 - When welding the pipe, the unit may get damaged by the heat and flame from welding. Use a flame proofing cloth to protect the unit from a welding fire or flame. Sensor for detecting outside temperature is located on the left side of the welding part so be extra careful not to damage the sensor when welding.
 - The O-ring and Teflon packing inside service valve may get damaged by the heat from welding. Wrap the bottom side of the service valve with a wet cloth and weld it as shown in the illustration. Also, water dripping from the wet cloth may interrupt the welding. Make sure the water does not drip from the wet cloth.
 - Make sure that connected pipes does not interrupt each other or make contact with the product. (Vibration may cause damage to the pipes.)
 - When removing the sealed pipe on the bottom side of the service valve, cut it with a pipe cutter first and then start the welding. When the sealed pipe is welded without cutting, you may get injured by the refrigerant within the pipe.

10. Installation

Outdoor unit

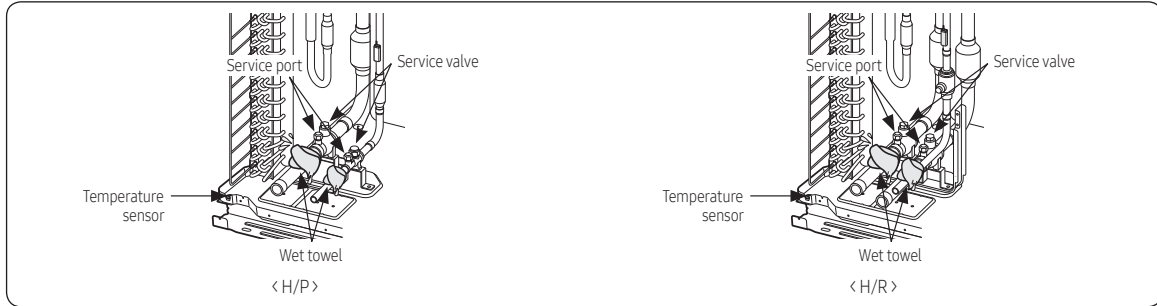

1 Pipe installation between the outdoor units

- You will need branch joints, which is an optional accessory, for connecting in between outdoor units in order to combine outdoor units in module.
- ✘ For optimal distribution of the refrigerant, you must use Y-joint as branch joint for connecting outdoor units. (Do not use T-joint)
- When you install the outdoor units in module, there is no restriction of installation order among outdoor units.
- Height of the connection pipe should be same or lower than the ones connected to the outdoor units.
- Check the changes in comparison with the DVM II, III and IV.

Caution	Correct installation	Incorrect installation
Refrigerant pipes should be connected at the same or lower level than the ones connected to the outdoor unit.		
Refrigerant pipes must be connected by the side of the product.		
Branch joint between outdoor units must be installed horizontally.		
Install a vertical trap in following cases as shown in the figure : Case1. Pipe length between outdoor unit branches exceeds 2m. Case2. Pipe length between outdoor unit and its branch exceeds 2m.		

10. Installation

Outdoor unit

Examples of refrigerant pipe installation

1 Using Y-joint

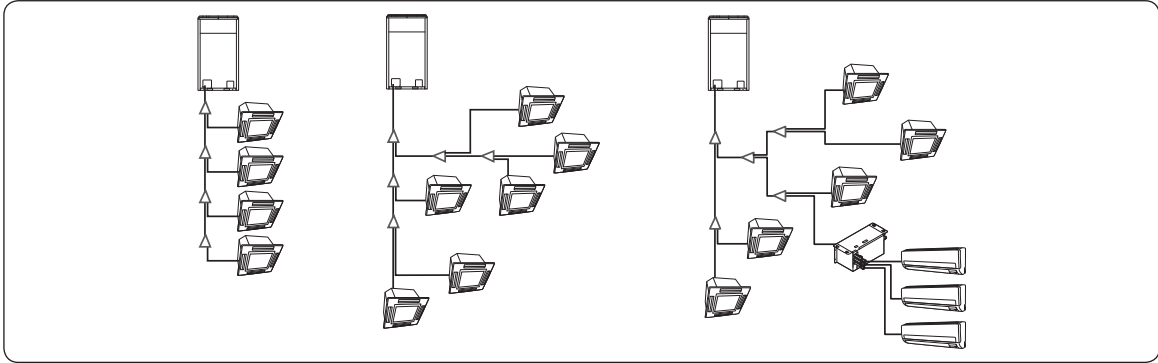

2 Using distribution header

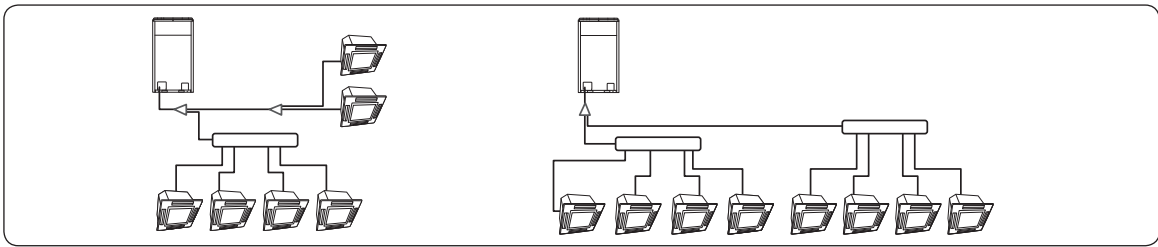

Allowable length of the refrigerant pipe and the installation examples

H/P

Classification	Single Installation	Module installation
Installing only with Y-joint	<p>Outdoor unit</p> <p>Branch joint</p> <p>Indoor unit</p>	<p>Outdoor unit</p> <p>Branch joint</p> <p>Indoor unit</p>
Installing with Y-joint and distribution header	<p>Outdoor unit</p> <p>Branch joint</p> <p>Distribution header</p> <p>Indoor unit</p>	<p>Outdoor unit</p> <p>Distribution header</p> <p>Branch joint</p> <p>Indoor unit</p>
Installing only with distribution header	<p>Outdoor unit</p> <p>Distribution header</p> <p>Indoor unit</p>	<p>Outdoor unit</p> <p>Distribution header</p> <p>Indoor unit</p>

10. Installation

Outdoor unit

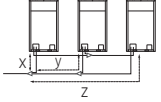
Classification				Example		Remarks
Maximum allowable length of pipe	Outdoor unit ~ Indoor unit	Actual length (Equivalent length)	200m and below (220m and below)	Installing only with Y-joint	$a+b+c+d+e+f+g+p \leq 200\text{m}(220\text{m})$	Equivalent length Y-joint: 0.5 m, Distribution header: 1 m
				Installing with Y-joint and distribution header	$a+b+h \leq 200\text{m}(220\text{m}),$ $a+i+k \leq 200\text{m}(220\text{m})$	
				Installing only with distribution header	$a+i \leq 200\text{m}(220\text{m})$	
	Total length of pipe (m)	1,000 m or less	Installing only with Y-joint	$a+b+c+d+e+f+g+h+i+j+k+l+m+n+p \leq 1000\text{m}$	-	
			Installing with Y-joint and distribution header	$a+b+c+d+e+f+g+h+i+j+k \leq 1000\text{m}$	-	
			Installing only with distribution header	$a+b+c+d+e+f+g+h+i \leq 1000\text{m}$	-	
Outdoor unit ~ Outdoor unit (Module installation)	Pipe length	10 m or less	$x \leq 10\text{ m}, y \leq 10\text{ m}, z \leq 10\text{ m}$			
	Equivalent length	13 m or less	$x \leq 13\text{ m}, y \leq 13\text{ m}, z \leq 13\text{ m}$			
Maximum allowable height difference of pipe	Outdoor unit ~ Indoor unit	110/110m <small>Note 2)</small>		H1 \leq 110/110m		
	Indoor unit ~ Indoor unit	50m or less		H2 \leq 50m		
		But, when AM****NQDEH* / AM***JNV* is installed, H2 is 15 m or less.				

Classification				Example		Remarks
Maximum allowable length after branch joint	First branch joint ~ Farthest Indoor unit	Pipe length	45 m or less	Installing only with Y-joint	$b+c+d+e+f+g+p \leq 45\text{ m}$	-
				Installing with Y-joint and distribution header	$i+k \leq 45\text{ m}$	
				Installing only with distribution header	$i \leq 45\text{ m}$	
		45 m~90 m <small>Note 1)</small>	Required conditions must be satisfied		-	

EEV kit			Model name		Remarks
EEV kit ~ Indoor unit	Actual pipe length	2 m	MEV-E24SA	1 indoor	Apply to products without EEV (Wall mount & ceiling)
			MEV-E32SA		
		20 m or less	MXD-E24K132A	2 indoor	
			MXD-E24K200A		
			MXD-E32K200A		
			MXD-E24K232A	3 indoor	
			MXD-E24K300A		
			MXD-E32K224A		
		MXD-E32K300A			

※ Please refer to the EEV Kit manual.
Note 1) Required condition

10. Installation

Outdoor unit

Classification	Condition	Example
First branch joint ~ Farthest Indoor unit	$45\text{m} \leq b+c+d+e+f+g+p \leq 90\text{m}$: branch pipes (b, c, d, e, f, g) size must be increased by 1 grade	
Total length of extended pipe	If the size of pipe (main pipe), between the first branch joint and the outdoor unit, is not increased by 1 grade, $a+(b+c+d+e+f+g) \times 2 + h+i+j+k+l+m+n+p \leq 1000\text{m}$	
	If the size of pipe (main pipe), between the first branch joint and the outdoor unit, is increased by 1 grade, $(a+b+c+d+e+f+g) \times 2 + h+i+j+k+l+m+n+p \leq 1000\text{m}$	
Each Y-joint ~ Each indoor unit	$h, i, j, \dots, p \leq 45\text{m}$	
Difference between the distance of the outdoor unit to the farthest indoor unit and nearest indoor unit $\leq 45\text{m}$, $(a+b+c+d+e+f+g+p) - (a+h) \leq 45\text{m}$		

Note 2) When indoor unit is located at higher level than outdoor unit, allowable height difference is 110m, (If the height difference is over 40m, contact your local dealer for more information.)
 but when the indoor unit is located at lower level than outdoor unit, allowable height difference is 110m (If the height difference is over 50m, need to decide whether to install PDM kit or not.)
 Model name of the PDM kit : MXD-A38K2A, MXD-A12K2A, MXD-A58K2A

How to connect the pipes

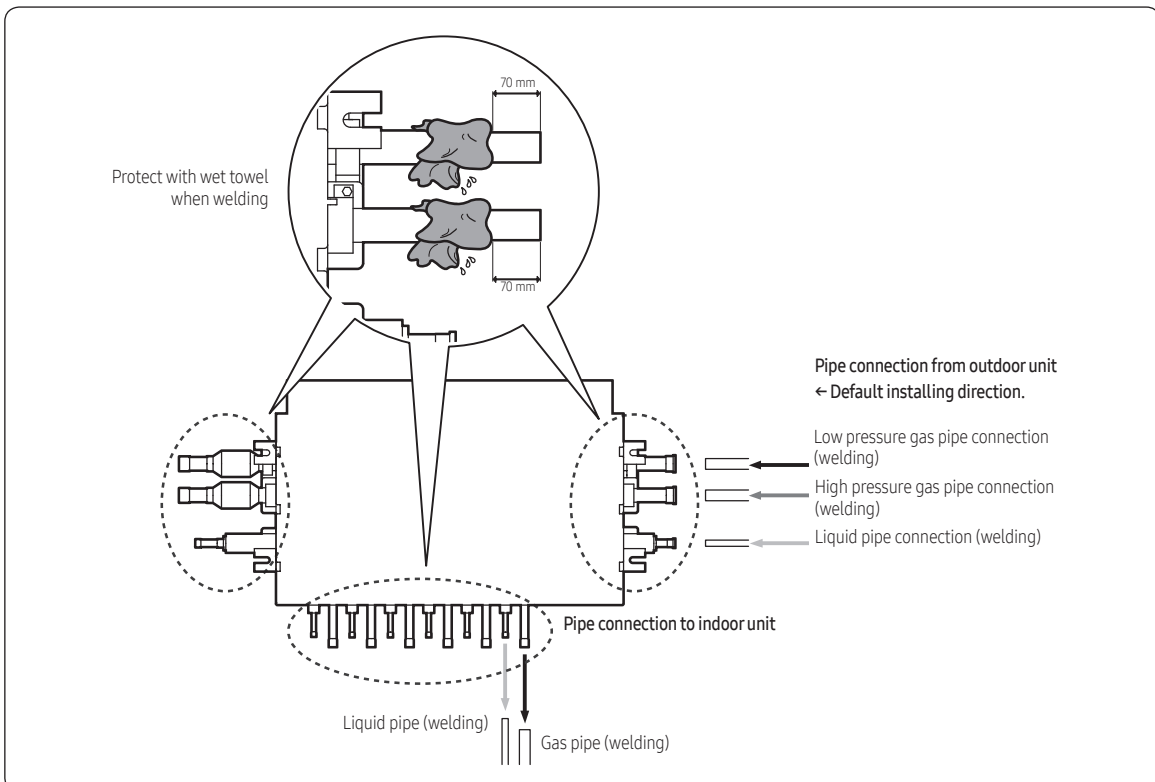

- ※ When installing MCU, use the pattern sheet for installation that is provided with the product.
- ※ When welding the gas pipes, protect the product with the flame-proof sheet.
- ※ When connecting the MCU with outdoor units, default direction is set in the MCU.
 If installing opposite direction, weld the enclosed copper cap in each high pressure, low pressure and liquid pipes.

10. Installation

Outdoor unit

- When installing outdoor units in module, select the power supply cable according to the sum of outdoor unit capacity. (Refer to the table for each model)
- Power Supply cords of parts of appliances for outdoor use shall not be lighter than polychloroprene sheathed flexible cord. (Code designation IEC:60245 IEC 66 / CENELEC: H07RN-F)
Ex.) AM500*XV***

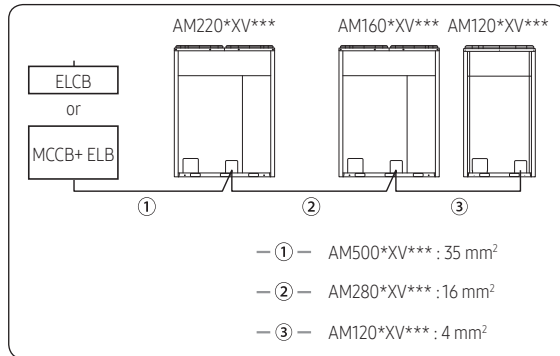

CAUTION

- Caution for electrical work
 - You must install ELCB or MCCB + ELB
 - ELCB: Earth leakage breaker
 - MCCB: Molded case circuit breaker
 - ELB: Earth leakage breaker
 - Do not operate the outdoor unit before completing the refrigerant pipe work.
 - Do not disconnect or change the cable inside the product. It may cause damage to the product.
 - Specification of the power cable is selected based on following installation condition; culvert installation/ ambient temperature 30 °C/ single multi conductor cables. If the condition is different from the ones stated, please consult an electrical installation expert and re-select the power cable.
 - If the length of power cable exceed 50m, re-select the power cable considering the voltage drop.
 - Use a power cable made out of incombustible material for the insulator (inner cover) and the sheath (outer cover).
 - Do not use the power cable with the core wire exposed due to insulator damage occurred during removal of the sheath. When the core wire is exposed, it may cause fire.

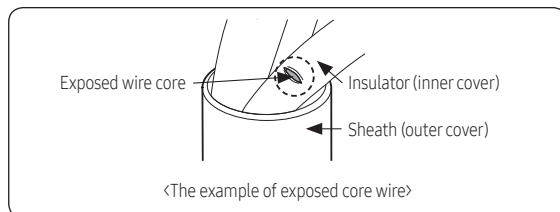

NOTE

- This device is intended for the connection to a power supply system with a maximum permissible system impedance shown in the table (on the left page) at the interface point (power service box) of the user's supply.
- The user must ensure that this device is connected only to a power supply system which fulfills the requirement above. If necessary, the user can ask the public power supply company for the system impedance at the interface point.
- This equipment complies with IEC 61000-3-12 provided that the short-circuit power S_{sc} is greater than or equal to $S_{sc}(*2)$ at the interface point between the user's supply and the public system. It is the responsibility of the installer or user of the equipment to ensure, by consultation with the distribution network operator if necessary, that the equipment is connected only to a supply with a short-circuit power S_{sc} greater than or equal to $S_{sc}(*2)$.

[$S_{sc}(*2)$]

Model	$S_{sc}(\text{MVA})$
AM080AXVGGH/EU	3.0
AM100AXVGGH/EU	3.4
AM120AXVGGH/EU	4.0
AM140AXVGGH/EU	4.4
AM160AXVGGH/EU	5.2
AM180AXVGGH/EU	6.4
AM200AXVGGH/EU	7.0
AM220AXVGGH/EU	7.4
AM240AXVGGH/EU	9.3
AM260AXVGGH/EU	10.2
AM080AXVAGH/EU	3.0
AM100AXVAGH/EU	3.7
AM120AXVAGH/EU	4.0
AM140AXVAGH/EU	4.6
AM160AXVAGH/EU	5.2
AM180AXVAGH/EU	6.3
AM200AXVAGH/EU	7.0
AM220AXVAGH/EU	7.4
AM240AXVAGH/EU	9.3
AM260AXVAGH/EU	10.2

Power and communication cable configuration

- Main power and the ground cable must be withdrawn through the knock-out hole on the bottom-right or right side of the cabinet.
- Withdraw the communication cable from the designated knock-out hole on the bottom-right side of the front part.
- Install the power and communication cable using separate cable protection tube.
- Fix a protection tube to the knock-out hole on the outdoor unit by using a CD connector or bushing. Make sure to use insulating bushing.

10. Installation

Outdoor unit

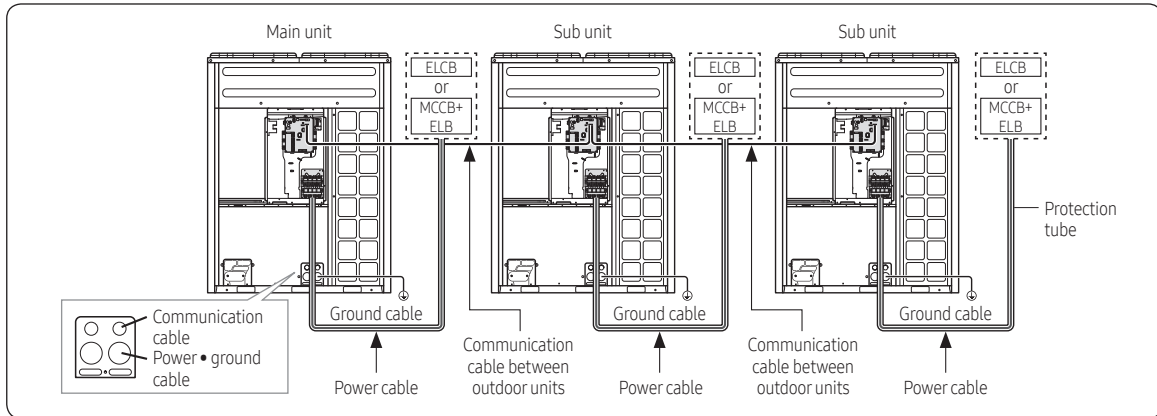

<When the module combination is in the tables of "Outdoor unit combination">

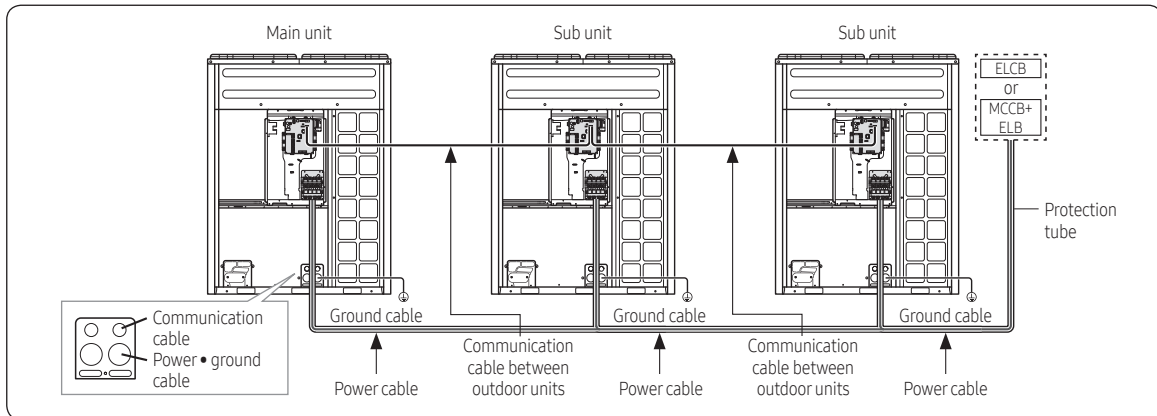

※ Power Supply cords of parts of appliances for outdoor use shall not be lighter than polychloroprene sheathed flexible cord. (Code designation IEC:60245 IEC 66 / CENELEC: H07RN-F)

Specification of the protection tube

Name	Temper grade	Applicable conditions
Flexible PVC conduit	PVC	When the protection tube is installed indoor and not exposed to outside, because it is embedded in concrete structure
Class 1 flexible conduit	Galvanized steel sheet	When the protection tube is installed indoor but exposed to outside so there are risk of damage to the protection tube
Class 1 PVC coated flexible conduit	Galvanized steel sheet and Soft PVC compound	When the protection tube is installed outdoor and exposed to outside so there are risk of damage to the protection tube and extra waterproof is needed

- After perforating the knock-out hole, apply rust resisting paint around the hole.
- When you need to pass the cables through the knock-out hole, remove burrs on the hole and protection the cable with a protection tape or bushing etc.
- Caution for installing communication cable
- When you connect the cable, it may sag and pressed by other parts. Therefore cables should be fixed to a clamp highlighted with a box on the illustration.

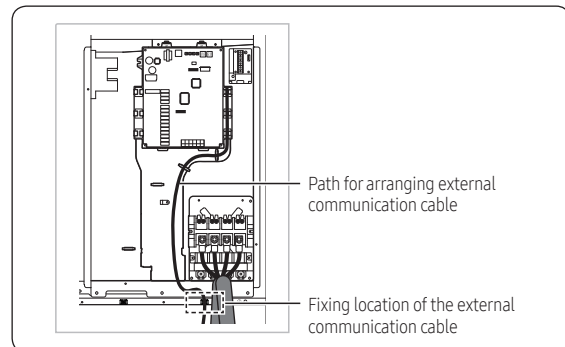

⚠ CAUTION

- Caution for perforating the knock-out hole
- Perforate a knock-out hole by punching it with a hammer.

10. Installation

Outdoor unit

Power wiring diagram

Supplying 3 phase 4 wires (380-415 V~)

<When the module combination is in the tables of "Outdoor unit combination">

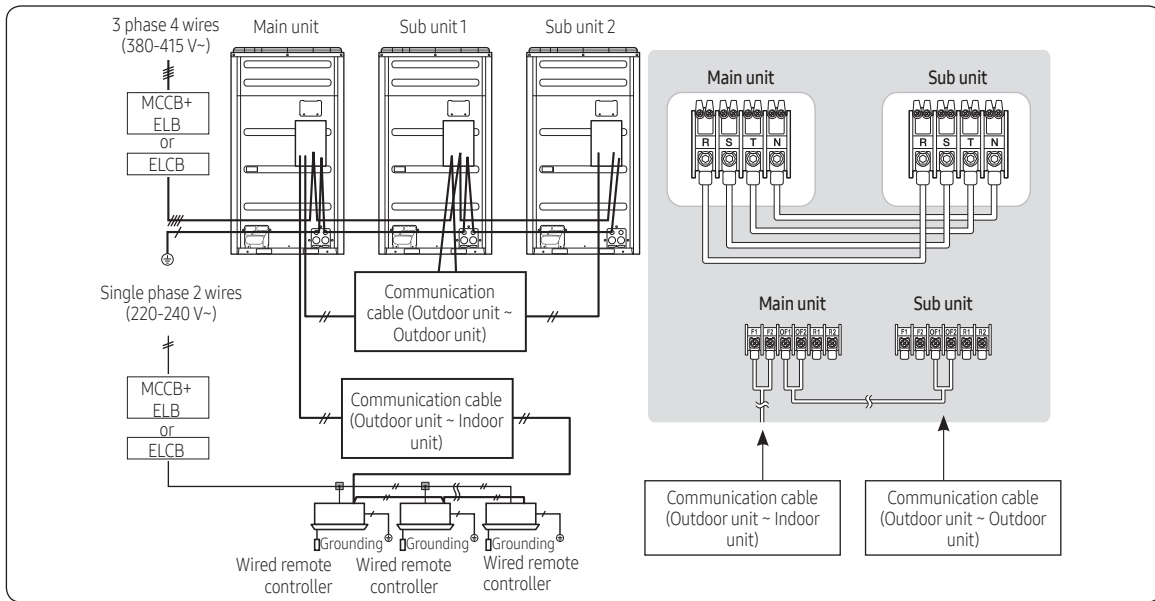

<When the module combination is not in the tables of "Outdoor unit combination">

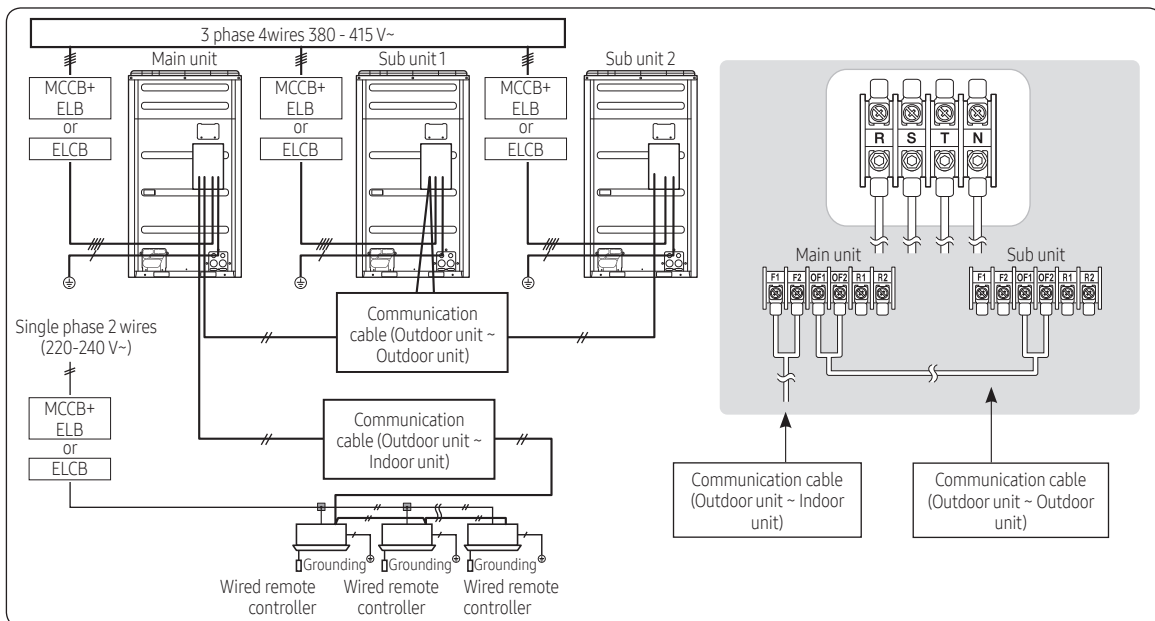

- Connect a power cable of the outdoor unit after checking that R-S-T-N (3 phase 4 wire) is properly connected. (If the 380-415 V power is supplied to the N phase, PCB and other electrical part will be damaged.)
 - Communication cable between indoor and outdoor units and communication cable between outdoor units has no polarity.
 - Arrange the cables with a cable tie.
- ※ ELCB and ELB must be installed since there is risk of electric shock or fire when they are not installed.

10. Installation

Outdoor unit

Selecting solderless ring terminal

- Select a solderless ring terminal for a power cable according to the nominal dimensions for cable.
- Apply insulation coating to the connection part of the solderless ring terminal and the power cable.

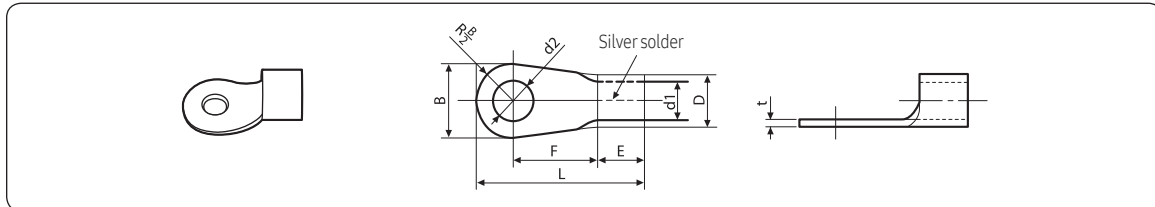

Nominal dimensions for cable (mm ²)		4/6	10	16	25	35	50	70			
Nominal dimensions for screw (mm)		4	8	8	8	8	8	8			
B	Standard dimension (mm)	9.5	15	15	16	12	16.5	16	22	22	24
	Allowance (mm)	±0.2		±0.2	±0.2	±0.3		±0.3	±0.3	±0.3	±0.4
D	Standard dimension (mm)	5.6	7.1	9	11.5	13.3	13.5	17.5			
	Allowance (mm)	+0.3	+0.3	+0.3	+0.5	+0.5	+0.5	+0.5			
d1	Standard dimension (mm)	3.4	4.5	5.8	7.7	9.4	11.4	13.3			
	Allowance (mm)	±0.2		±0.2	±0.2	±0.2		±0.2	±0.3	±0.4	
E	Min. (mm)	6	7.9	9.5	11	12.5	17.5	18.5			
F	Min. (mm)	5	9	9	13	15	13	13	14	20	
L	Max. (mm)	20	28.5	30	33	34	38	43	50	51	
d2	Standard dimension (mm)	4.3	8.4	8.4	8.4	8.4	8.4	8.4	8.4	8.4	
	Allowance (mm)	+0.2	+0.4	+0.4	+0.4	+0.4	+0.4	+0.4	+0.4	+0.4	
t	Min. (mm)	0	0	0	0	0	0	0			
	Min. (mm)	0.9	1.15	1.45	1.7	1.8	1.8	2.0			

Connecting the power terminal

- Connect the cables to the terminal board with solderless ring terminals.
- Properly connect the cables by using certified and rated cables and make sure to fix them properly so that external force is not applied to the terminal.
- Use a driver and wrench that can apply the rated torque when tightening the screws on the terminal board.
- Tighten the terminal screws by complying rated torque value. If the terminal is loose, fire can occur due to arc heat generation and if the terminal is too tight, terminal board could get damaged.

1 Front connection

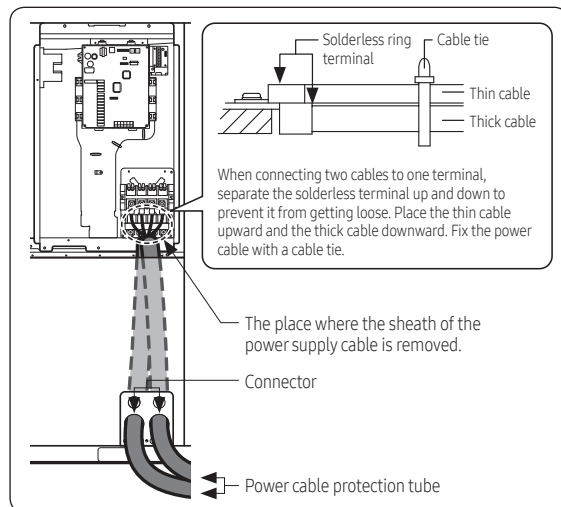

10. Installation

Outdoor unit

1 Closing the cover

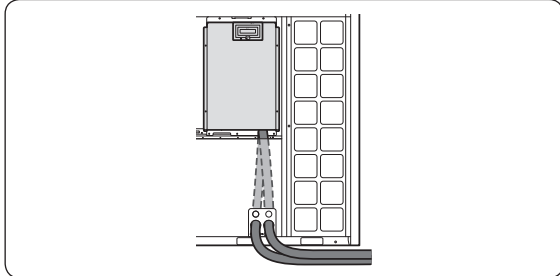

Screw	Tightening torque for terminal (N·m)	
M4	1.2-1.8	Single phase (220-240 V) power cable
M8	5.5-7.3	3 phase (380-415 V) power cable

CAUTION

- When removing the outer sheath of the power supply cable, be careful not to scratch the inner sheath of the cable.
- Make sure that more than 20mm of the outer sheath of the indoor unit power and communication cable are inside the electrical component box.
- Install the communication cable separately from power cable and other communication cables.
- There is a risk of electric shock when power is applied. Close the cover of the control box before proceeding to work.
- To inspect the compressor or PBA, first make sure to turn off the system. Electricity may flow even in a compressor that has not been used recently. Exercise caution to protect yourself from an electric shock.

Fixing the power cable

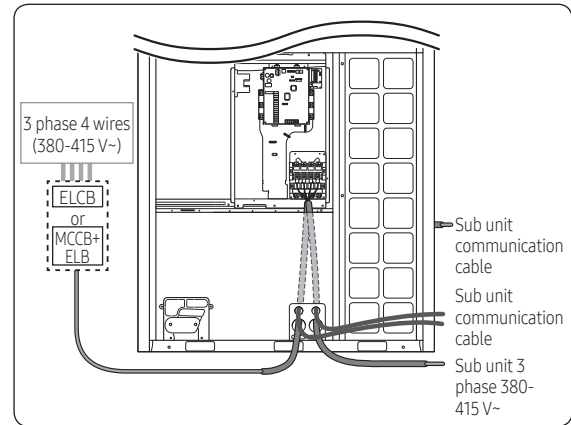

CAUTION

- Do not let the power cable come into contact with the pipes inside the outdoor unit. If the power supply cable touches the pipes, the vibration of the compressor is transferred to the pipes and can damage the power supply cables or pipes, creating the danger of fire or explosion.
- Make sure that the place where the sheath of power supply cable is removed is inside the power supply box. If it is impossible, you should connect the protection tube for power cable to the power supply box.
- After arranging the power cable into the power supply box, tighten the cover.

10. Installation

Outdoor unit

Connect the ring terminal of 3 phase cable

- 1 Cut the power cable to an appropriate length and connect it with the solderless terminal.
- 2 After connecting the power cable to the terminal as seen in the illustration, fix it with cable tie.
- 3 Fix the housing, which has an insulator, to the terminal board.

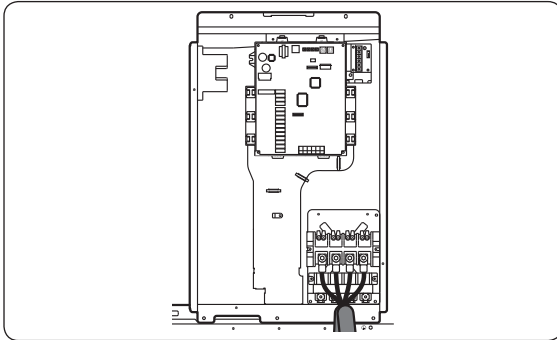

Fixing the ground cable

- Connect the ground cable to the grounding hole inside the power supply box.

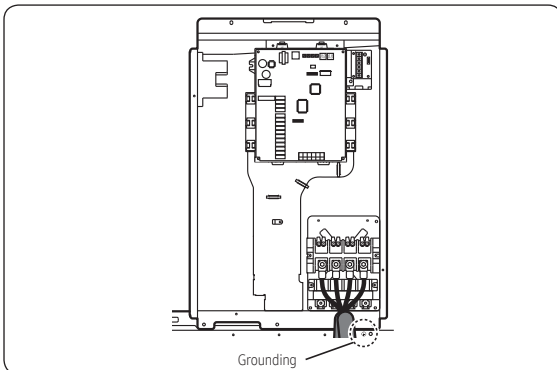

Withdrawing the power cable

- Withdrawing from the front side
 - Connect the power cable protection tube into the power supply box as shown picture.
 - Be sure that the power supply cable is not damaged by burr on the knock-out hole.

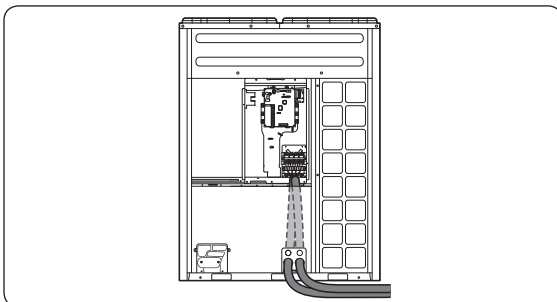

Installing the Solution device

- When the number of indoor units installed with the outdoor unit is 16 or less

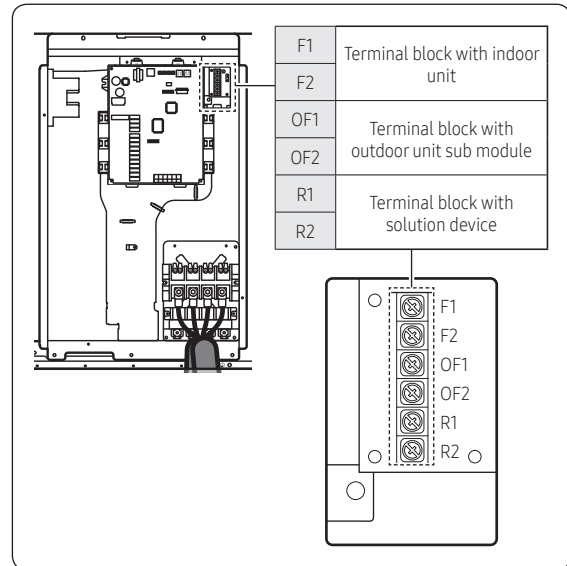

Where to install the interface module

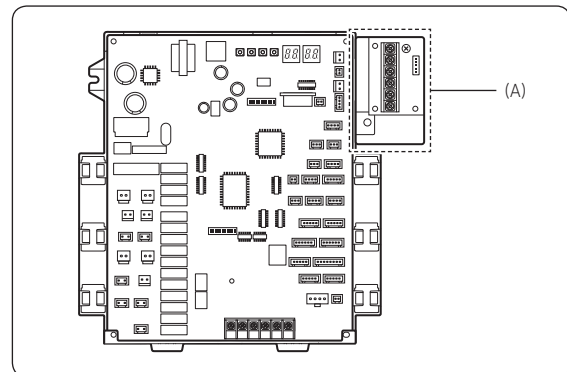

- Install the interface module in location (A), considering the installation conditions.
 - For details on how to install, refer to the interface module installation manual.

2021.07
Ver.3.0

Samsung Electronics Co., LTD.

Head Office (Suwon Korea) 129, Samsung-Ro, Yeongtong-Gu, Suwon City, Gyeonggi-Do, Korea 16677
Website : www.samsung.com, <http://btsp.samsungsbn.com> Email : airconditioner@samsung.com
Images and data in this book may subject to change without prior notice.