

Price List 2022 / 2023

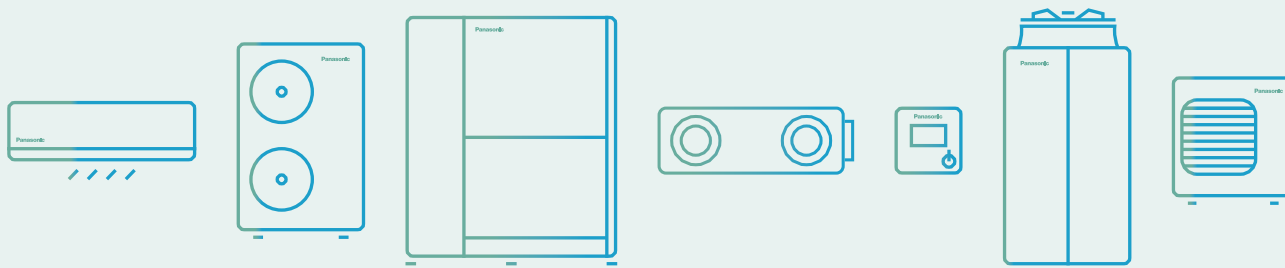

Editorial

Panasonic – leading the way in Heating and Cooling. With more than 50 years of experience, selling to more than 120 countries around the world, Panasonic is one of the leaders in the heating and cooling sector.

Bringing nature's balance indoors.

nanoe™ X, technology with the benefits of hydroxyl radicals.



PRO Club. The professional website of Panasonic.

Panasonic has an impressive range of support services for designers, specifiers, engineers and distributors working in the heating and cooling markets.



Domestic

Panasonic has developed a range of domestic products designed for you and your clients.

Etherea: Welcome to your new home.

Designed to produce the ultimate comfort and performance for homeowners, the new Etherea is a worthy addition to any indoor environment. Now available in Matt White, Silver and Graphite grey color.



nanoe™ X: improving protection 24/7.

nanoe™ X technology brings nature's detergent – hydroxyl radicals – indoors, so that hard surfaces, soft furnishings, and the indoor environment can be a cleaner and more pleasant place to be.



Commercial

The commercial range is constantly expanding so that you can always offer your clients the optimal solutions: high performance, silent machines and a complete range of ducts, cassettes and ceiling installations.

PACi NX Series.

This series has been developed with 3 wired method and communication. It makes it simple and easy to replace old systems with 3 wire connections, which is prevalent in many systems.



CONEX. Devices and apps.

CONEX provides comfort and control for varying user needs. Accessible, flexible and scalable with different controllers and apps. Perfectly meeting requirements of modern controls for end user, installer and service.

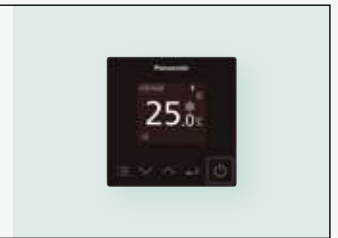

VRF Systems

The VRF industrial range considerably improves efficiency so even large buildings can benefit from a high-level of comfort with less energy consumption.

Mini ECOi LZ2 Series R32.

The Mini ECOi LZ2 Series utilizes environmentally friendly R32 refrigerant, reducing the total amount of refrigerant by 20 % and more, resulting in lower GWP, reduced by 75 %.



nanoe™ X.

Panasonic's nanoe™ X technology brings nature's detergent – hydroxyl radicals – indoors to help improve protection 24/7. Available in 4 way 90x90 cassette, floor console and adaptive ducted unit.



Ventilation

Panasonic ventilation solutions for maximum savings and easy integration.

AHU connection kit 3.6 to 14.0 kW for PACi NX.

The Panasonic AHU connection kits offer a wealth of connectivity possibilities so can be easily integrated into many systems.



Energy recovery ventilation.

Panasonic energy recovery ventilators help you with your comfort and energy-saving plan.

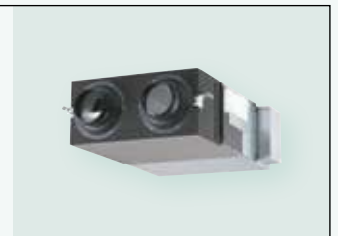

Control and connectivity

From the individual remote controller for the residential single units up to the newest technology capable of controlling your building anywhere in the world.

Panasonic AC Smart Cloud.

Panasonic AC Smart Cloud provides building mapping, remote monitoring, error notification and schedule setting for site managers. Panasonic AC Service Cloud help maintenance companies to manage multiple sites with remote checking and advance failure prediction functions.



Panasonic AC Service Cloud.

Panasonic AC Service Cloud provides to maintenance company a unique tool to deliver advanced maintenance to increase response time, reduce sites visits and allocate better the resources.



Chiller

Panasonic introduces the ECOi-W heat pumps and cooling only chiller series. These series provides a wide variety of HVAC system solutions, to meet all of your residential, commercial and industrial needs.

ECOi-W heat pump and cooling only chillers.

An extensive line up from 20 kW to 210 kW with an operating range of -17 °C (heating) to 50 °C (cooling). Offering a high quality, flexible solution for commercial applications.



Explore the range of fan coils.

Available in a wide range of designs, the fan coils are perfectly adapted to fit within almost any location.



Refrigeration

Panasonic condensing units with natural refrigerant.

Panasonic is now introducing the environmentally friendly CO₂ condensing units for commercial refrigeration.

Refrigeration.

Offering a range of CO₂ solutions from 2 HP to 10 HP, including a new 4 HP unit. Medium or low temperature set-points available, offering a flexible installation for various applications.



CO₂ Condensing units CR Series by trusted technology.

CR Series are made in Japan with an excellent quality control established by skilled factory team.



Conditions and conversion

Nominal and UK conditions.

Nominal capacities (kW) specified in this price book are calculated under ISO-T1 (JIS) standard conditions as follows:

Cooling.

Indoor temperature 27°CDB, 19°CWB
Outdoor temperature 35°CDB

Heating.

Indoor temperature 20°CDB
Outdoor temperature 7°CDB, 6°CWB

UK cooling capacities (kW) specified in this price book

are calculated under the following conditions:
Indoor temperature 23°CDB, 16°CWB
Outdoor temperature 30°CDB

UK heating capacities (kW) specified in this price guide are calculated under the following conditions:
Indoor temperature: 20°CDB
Outdoor temperature: 0°CWB

Electrical.

Information relating to local power supplies are shown for guidance only and must be subject to IEE regulations as well as site requirements. All three phase supplies to be TPNE.

Energy labelling.

All ENER - Lot 10 information is available at http://www.panasonicproclub.com/GB_en/tools/energy-label-generator/



Pipe size.

1/4in = 6.35mm
3/8in = 9.52mm
1/2in = 12.70mm
5/8in = 15.88mm
3/4in = 19.05mm
7/8in = 22.22mm
11/8in = 28.58mm
13/8 = 34.93mm

Conversion data.

kW x 3412 = btu/h
°C x 1.8 + 32 = °F
l/s x 3.6 = m³/h
bar x 14.51 = psi
m² x 10.76 = ft²



Quality Management System Certificate



ISO 9001: 2015
Panasonic Appliances Air-Conditioning
Malaysia. Sdn Bhd.
Cert. No.: AR 1010



GB/T 19001-2016/ISO 9001: 2015
Panasonic Appliances Air-Conditioning
(GuangZhou) Co., Ltd.
Registration Number: 01218Q30835R8L

Environmental Management System Certificate



ISO 14001: 2015
Panasonic Appliances Air-Conditioning
Malaysia Sdn Bhd.
Cert. No.: EMS 00109



GB/T 24001-2016/ISO 14001: 2015
Panasonic Appliances Air-Conditioning
(GuangZhou) Co., Ltd.
Registration Number: 02118E10944R7M

Panasonic environmental vision 2050

To achieve “a better life” and “a sustainable global environment,” Panasonic will work towards creation and more efficient utilisation of energy which exceeds the amount of energy used, aiming for a society with clean energy and a more comfortable lifestyle.

2050

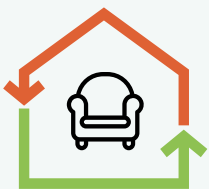

Energy used < Energy created

One initiative in the Panasonic environmental vision 2050 is offering products with greater energy efficiency. In 2018, we celebrated the 60th anniversary of our heating and cooling solutions business. Our expertise gained over the years has helped us launch a range of products that contribute to a more carbon-free society.

Current status of energy used and energy created

Energy used by Panasonic business activities and products.

10 Energy used

Clean energy created and / or made available by Panasonic products, etc.

1 Energy created

Working to realise environmental vision 2050

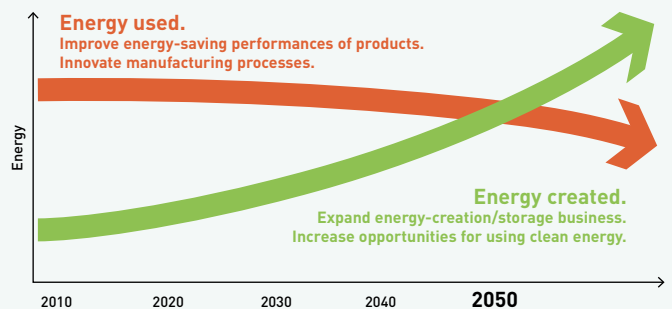

Projects and case studies of Panasonic Heating & Cooling Solutions



Panasonic, a partner with the knowledge and experience to achieve your objectives and green needs.

Integrated technology that permits better work, easy installation, high efficiency performance, and energy savings

Our main targets are the distributed services and B2B-integrated solutions.

Panasonic provides a single point of contact for the design and maintenance of your system, making things easy for you. Given our experience in processes, technologies and complex business models, we can offer you effective solutions that reduce costs, whilst also being efficient, user-friendly, reliable and innovative. Another advantage we offer to our clients is a support service for systems integration projects, which we provide through our wide range of services and solutions. As a global company, we have at our disposal the financial, logistical and technical resources to develop complex and wide-ranging solutions, both at country and international level by implementing them both on-time and on-budget.



Aquarea Heat Pumps provide heating and hot water for new rural housing development, UK. **Aquarea**



The Hotel Vincci Gala with efficiency class A, up to 70 % save energy. Barcelona, Spain. **ECOi - ECO G**



STEMCELL Technologies, a global biotechnology company, installed CO₂ condensing units for cold rooms in the warehouse. France. **Refrigeration**



The EDEKA store in Germany, the first supermarket providing the maintenance-free nanoe™ X technology for better indoor air quality. Germany. **ECOi and nanoe™ X**



Aquarea T-CAP provides a complete solution of heating, cooling and DHW for the refurbishment of a luxury house in Voorthuizen, Netherlands. **Aquarea**



CÉDRUS LIGET, a complex facility including apartments, penthouses and showrooms etc. Hungary. **ECOi-W - ECOi - PACi**



Dolomiti Lodge Alverà hotel with nice wooden furnishings, located in Cortina d'Ampezzo, Italy. **ECOi**



LIAIGRE showroom, well-known as a luxury design architect in Paris, France. **ECOi**



Marina Village Greystones. 205 apartments and 153 houses. Ireland. **Aquarea**



ITK Engineering GmbH. An innovative office building located in Germany. **ECOi - PACi**



A historic building on Amsterdam's Marineterrein. Netherlands. **ECOi-W**



Nolan's supermarket in Ireland installs the first Panasonic CO₂ Condensing Units for showcases. Ireland. **Refrigeration**

A desire to create things of value



"Recognising our responsibilities as industrialists, we will devote ourselves to the progress and development of society and the well-being of people through our business activities, thereby enhancing the quality of life throughout the world."

Panasonic Corporation's Basic Management Objective, formulated in 1929 by the company's founder, Konosuke Matsushita.

Panasonic becomes one of the first Japanese air conditioner manufacturers in Europe.



World's first air conditioner equipped with nanoe™



First room air conditioner launched for domestic installation.



Introduces first GHP (gas heat pump) VRF air conditioner.



1958

1971

1975

1982

1985

1989

2008

2010



Starts production of absorption chillers.



Panasonic launches the first highly efficient air to water heat pump in Japan.



Introduces world's first simultaneous 3-Pipe heating / cooling VRF System.



New Aquarea. Panasonic introduces Aquarea, an innovative new, low-energy system in Europe.

Vitalize the future with air

These are times of exceptional challenge.

If the world is to move forward confidently, it must overcome the serious threats of the new global pandemics and the degrading of the environment. It must find ways large and small to reduce the stresses that affect people's health and the stability of their communities.

At Panasonic, we're utilizing the power of air to create positive change.

Air that benefits body and mind.

Air that energizes the places where people gather to work and play.

Air that reduces our burden on the Earth.

With more than a century of research and expertise to guide us, we're using air to open a more hopeful and vital future for all.

New Panasonic GHP units.

The gas-driven VRF Systems are ideal for projects where power restrictions apply.



New VRF Systems ECOi EX with extraordinary energy saving performance.

Panasonic introduces a new Chiller series which is named as ECOi-W.



Mini VRF R32 up to 10 HP. Outstanding efficiency in a compact body.



2012

2015

2016

2018

2019

2020

2021

Looking ahead



The first Hybrid System with VRF and GHP in Europe.



CO₂ condensing units in Europe. The ideal solution for supermarkets, shops and gas stations.



nanoe™ X, technology with the benefits of hydroxyl radicals. Improving protection 24/7.

Bringing nature's balance indoors



nanoe™ X, technology with the benefits of hydroxyl radicals.



In today's health-conscious world, we care about taking exercise, we care about what we eat and what we touch, we also care about what we breathe – and technology exists to bring good outdoor air, indoors.

WE BREATHE IN
18 Kg
OF AIR A PERSON
A DAY

WATER
1.2 Kg
A PERSON
A DAY

FOOD
1.3 Kg
A PERSON
A DAY

Abundant in nature, hydroxyl radicals (also known as OH radicals) have the capacity to inhibit pollutants, viruses, and bacteria to clean and deodorise. nanoe™ X technology can bring these incredible benefits indoors so that hard surfaces, soft furnishings, and the indoor environment can be a cleaner and more pleasant place to be, whether at home, work, or visiting hotels, shops and restaurants etc.

A naturally occurring process

Hydroxyl radicals are unstable molecules looking to react with other elements like hydrogen, capturing it. Thanks to this reaction, hydroxyl radicals have the potential to inhibit the growth of pollutants such as bacteria, viruses, moulds, and odours, breaking them down and neutralising the unpleasant effects. This naturally occurring process has major benefits to improve indoor environments.



Hydroxyl radicals in nature.



Hydroxyl radicals contained in water.

By creating hydroxyl radicals contained in water, nanoe™ X technology significantly boosts their effectiveness, increasing hydroxyl radicals lifetime from less than a second in nature, to more than 600 seconds – 10 minutes so that nanoe™ X can spread easily around the room.

Panasonic's nanoe™ X technology takes this a step further and brings nature's detergent – hydroxyl radicals – indoors to help create an ideal environment

Thanks to the nanoe™ X properties, several types of pollutants can be inhibited such as certain types of bacteria, viruses, mould, allergens, pollen and certain hazardous substances.



1 | nanoe™ X reliably reaches pollutants.



2 | Hydroxyl radicals denature pollutants' proteins.



3 | Pollutants activity is inhibited.

The well-being benefits of nature are well known – but do you know the power of hydroxyl radicals?

What is unique about nanoe™ X?

Hydroxyl radicals inhibit pollutants, certain types of viruses, and bacteria to clean and deodorise. Thanks to this advanced technology, even tightly woven fabrics can be treated using this solution, meaning that curtains, blinds, carpets and furniture can all benefit from this technology to inhibit hazardous substances – including on hard surfaces and, of course, the air that we breathe.



Effective on fabrics and surfaces.

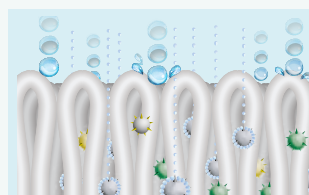

1 | At one billionth of a metre, nanoe™ X is much smaller than steam and can deeply penetrate cloth fabrics to deodorise.

Longer lifespan.



2 | Contained in tiny water particles, nanoe™ X has a longer lifespan to spread easily around the room.

Huge quantity.



3 | nanoe X Generator Mark 2 produces 9.6 trillion hydroxyl radicals per second. Greater amounts of hydroxyl radicals contained in nanoe™ X lead to higher performance on inhibition of pollutants.

Maintenance-free.



The image shows nanoe X Generator Mark 2.

4 | No maintenance, no replacement required. nanoe™ X is a filter free solution that does not require maintenance, as its atomisation electrode is enveloped with water during its generation process and it is made with Titanium.

7 effects of nanoe™ X – Panasonic unique technology

Deodorises



Odours

Capacity to inhibit 5 types of pollutants



Bacteria and viruses



Mould



Allergens



Pollen



Hazardous substances

Moisturises



Skin and hair

* Refer to <https://aircon.panasonic.eu> for more details and validation data.

The latest nanoe™ X device uses a “multi-leader discharge” system that focuses the discharge to 4 needle-shaped electrodes, greatly expanding the hydroxyl radicals.



The image shows nanoe X Generator Mark 1.

How nanoe™ X is generated.

- 1 | Atomised electrode produces condensation.
- 2 | Electrical discharge is applied to the water
- 3 | nanoe™ X particles are generated

nanoe™ X, internationally-validated technology in testing facilities

The effectiveness of nanoe™ X technology has been tested by 3rd party laboratories in Germany, France, Denmark, Malaysia and Japan.

Test results conducted under controlled laboratory conditions. Performance of nanoe™ X might differ in real life environment.

Panasonic heat pump with nanoe™ X technology verified against SARS-CoV-2

Virus SARS-CoV-2: 91.4 % inhibited. Test conducted by TEXCELL (France), using a gauze saturated with SARS-CoV-2 virus solution exposed to Panasonic heat pump with nanoe™ X in a space of 6.7 m³ over 8 hours. Test report: 1140-01 C3. Performance of nanoe™ X might differ in real life environment.

	Tested contents		Result	Capacity	Time	Testing organisation	Report No.
Airborne	Virus	Bacteriophage ΦX174	99.7 % inhibited	Approx. 25 m³	6 h	Kitasato Research Center for Environmental Science	24_0300_1
	Bacteria	Staphylococcus aureus	99.9 % inhibited	Approx. 25 m³	4 h	Kitasato Research Center for Environmental Science	2016_0279
Adhered	Virus	SARS-CoV-2	91.4 % inhibited	6.7 m³	8 h	Texcell (France)	1140-01 C3
		SARS-CoV-2	99.9 % inhibited	45 L	2 h	Texcell (France)	1140-01 A1
		Feline Coronavirus	99.3 % inhibited	45 L	2 h	Yamaguchi University Faculty of Agriculture	—
		Xenotropic murine leukemia virus	99.999 % inhibited	45 L	6 h	Charles River Biopharmaceutical Services GmbH	—
		Influenza (H1N1 subtype)	99.9 % inhibited	1 m³	2 h	Kitasato Research Center for Environmental Science	21_0084_1
		Bacteriophage ΦX174	99.80% inhibited	25 m³	8 h	Japan Food Research Laboratories	13001265005-01
	Bacteria	Staphylococcus aureus	99.9 % inhibited	20 m³	8 h	Danish Technological Institute	868988
	Pollen	Ambrosia pollen	99.4 % inhibited	20 m³	8 h	Danish Technological Institute	868988
		Cedar	97 % inhibited	Approx. 23 m³	8 h	Panasonic Product Analysis Center	4AA33-151001-F01
	Odours	Cigarette smoke odour	Odour intensity reduced by 2.4 levels	Approx. 23 m³	0.2 h	Panasonic Product Analysis Center	4AA33-160615-N04

The nanoe™ X performance varies depending on the room size, environment and usage and it may take several hours to reach the full effect. nanoe™ X is not medical device, local regulations on building design and sanitary recommendations must be followed.

First nanoe™ device was developed by Panasonic in 2003

Generator: nanoe™	Generator: nanoe™ X	
2003	Mark 1 - 2016	Mark 2 - 2019
480 billion hydroxyl radicals/sec	4.8 trillion hydroxyl radicals/sec	9.6 trillion hydroxyl radicals/sec

Ion particle structure

Hydroxyl Radicals

10x times

20x times

nanoe X Generator Mark 1 can reduce cigarette smoke odour intensity by 2.4 levels in 12 minutes

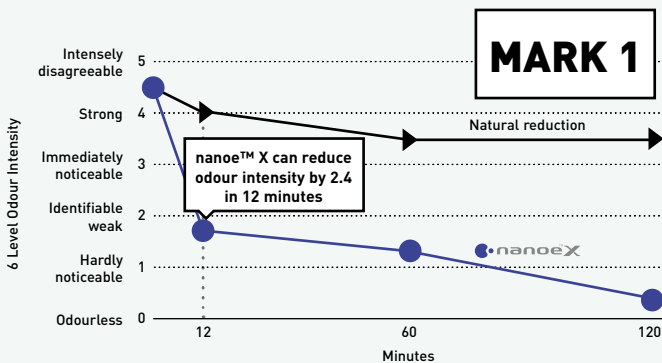

Deodorisation effect for adhering odour (cigarette smoke). Deodorisation test.
 Testing organisation: Panasonic Product Analysis Center. Testing method: Verified using the six-level odour intensity scale method in an approximately 23 m³ sized test room. Deodorisation method: nanoe™ released. Test substance: Surface-attached cigarette smoke odour. Test result: Odour intensity reduced by 2.4 levels in 12 minutes. (4AA33-160615-N04).

nanoe X Generator Mark 2 can reduce the aged-related body odour in half of the time

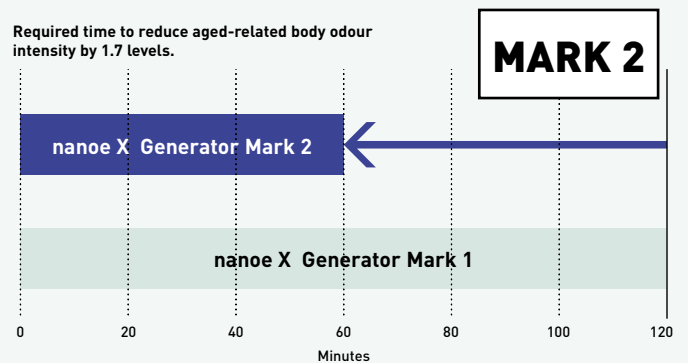

Deodorisation test.
 Testing organization: Panasonic Product Analysis Center. Testing method: Verified using the six-level odour intensity scale method in an approximately 23 m³ sized test room. Deodorisation method: nanoe™ released. Test substance: Surface-attached aged related body odour. Test result: Odour intensity reduced by 1.7 levels in 1 hour (Y18HM059).

Where is nanoe™ X technology used?

Since 2003, nanoe™ has become a part of people's lives in Japan and other regions.

Such technology can be found in diverse applications for cleaning air and surfaces, inside trains, elevators, cars, home appliances and personal beauty ... as well as in air conditioning.

Panasonic Heating & Cooling Solutions is incorporating nanoe™ technology in a wide range of equipment for residential applications as well as for commercial spaces and, it is a solution that does not require filters or maintenance and can work independently from heating or cooling.



Home



Shop



Gym



Hotel



Office



Clinic



Restaurant



Hospital

It has been adopted in people's homes as well as in public facilities where improved air quality is desired, such as offices, hospitals, healthcare centres and hotels etc.

nanoe™ X: improving protection 24/7



Panasonic Heating & Cooling Solutions is incorporating nanoe™ technology in a wide range of equipment

Home.

Built-in nanoe X Generator Mark 2.

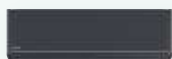

Wall-mounted Etherea XZ-H.
CS-XZ**XKEW-H.
3 capacities: 2.0 - 3.5 kW.



Wall-mounted Etherea XZ.
CS-XZ**XKEW.
4 capacities: 2.0 - 5.0 kW.

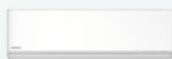

Wall-mounted Etherea Z.
CS-(M)Z**XKEW.
7 capacities: 1.6 - 7.1 kW.

Built-in nanoe X Generator Mark 1.



Floor console.
CS-Z**UFEAW.
3 capacities: 2.5 - 5.0 kW.

Commercial.

PACi NX. Built-in nanoe X Generator Mark 1.



4 way 90x90 cassette.
S-****PU3E.
7 capacities: 3.6 - 14.0 kW.

PACi NX. Built-in nanoe X Generator Mark 2.

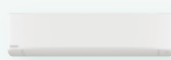

Wall-mounted.
S-****PK3E.
5 capacities: 3.6 - 10.0 kW.



4 way 60x60 cassette.
S-***PY3E.
4 capacities: 2.5 - 6.0 kW.



Ceiling.
S-****PT3E.
7 capacities: 3.6 - 14.0 kW.



Adaptive ducted unit.
S-****PF3E.
7 capacities: 3.6 - 14.0 kW.

VRF. **NEW** Built-in nanoe X Generator (TBC).



Y3 Type 4 way 60x60 cassette.
S-***MY3E.
6 capacities: 1.5 - 5.6 kW.

VRF. Built-in nanoe X Generator Mark 2.



U2 Type 4 way 90x90 cassette.
S-***MU2E5B.
11 capacities: 2.2 - 16.0 kW.

VRF. Built-in nanoe X Generator Mark 1.



F3 Type adaptive duct.
S-***MF3E5B.
12 capacities: 1.5 - 16.0 kW.

VRF. Built-in nanoe X Generator Mark 1.



G1 Type floor console.
S-**MG1E5N.
5 capacities: 2.2 - 5.6 kW.

nanoe™ X: improving protection 24/7

PRO Club. The professional website of Panasonic

Panasonic has an impressive range of support services for designers, specifiers, engineers and distributors working in the heating and cooling markets.



Panasonic PRO Club (www.panasonicproclub.com) is the online tool which makes your life easier! You just have to register and a lot of functionalities are freely available to you, where ever you are, from your computer or smartphone!

- Print catalogues with your logo and contact details
- Access to the extensive library of professional design, selection and calculation tools (Aquarea Designer, VRF software, chiller selector, etc.)
- Get documents of conformity and all other documents you may need
- Download all the service manuals, end user manuals and installation manuals
- Download energy labels in PDF format using the energy label generators
- Download Revit and CAD files and specification texts
- Know what to do with error codes (error code search by error code or unit ref.)
- PRO Academy: register for training
- Download product images in high resolutions, advertisements, deco guidelines
- Get to know special offers and promotions
- Find out about the latest news first



Easy download Panasonic service documentation and brochures



Customise leaflets with your logo and contact details. Save and print the PDF



Energy label generator. Download Energy labels of any device in PDF format



Error Code on your smartphone and your PC: Search by error code or model reference. Online version + downloadable version for offline use

Panasonic PRO Club is fully compatible with tablet computer and smartphone.

Visit www.panasonicproclub.com or connect simply with your smartphone to the PRO Club using this QR.

PRO Club 



Panasonic provides bespoke software and tools helping system designers, installers and dealers to very quickly select, design and size systems or create wiring or hydraulic diagrams at the push of a button.

Aquarea Designer - online tool



With Panasonic's online tool, projects can be developed simply and easily. The newly developed tool is optimised to help HVAC professionals easily identify the most appropriate Aquarea air to water heat pump for a particular application.



Domestic multi split selector

This user-friendly online tool for our domestic range allows to choose the best split or multi-split system for each project needs and get the specifications of that particular application.



VRF Designer



Building on the success of the ECOi VRF Designer software, this package provides air conditioning system designers, installers and dealers with a program to design and size projects for Panasonic's VRF ranges.



Open BIM



Design, analysis and BIM modeling of Panasonic VRF and Air to Water heat pump systems. Generates documents, 3D model, schematics and drawings. This application is integrated into the Open BIM workflow via the BIMserver.center platform.



Chiller configurator

This online software solution offers a complete tool to allow the user to accurately calculate the performance at specified conditions, select and configure our range of commercial chillers, heat pumps and fan coils. It also provides a comprehensive report to share with customers and clients alike.



Refrigeration tool

Panasonic has launched a new online calculator to support engineers, installers, and technicians to quickly make calculations when specifying solutions for commercial refrigeration systems.



More than 40 years of experienced organization in Europe

The partner for all Europe.

- Full European coverage and integrated organization
- One voice for European Agreements
- Availability and delivery anywhere in Europe
- Specification team to support project design throughout Europe
- European Service Network

Trained professionals.

- 37 Training centres in 19 countries
 - More than 5000 professionals trained every year.
- Innovation and manufacture in Europe

R&D Department designs solutions for different European needs.

- New factory set up in Czech Republic
- Design software made in Europe for Europe

More than cooling, heating and refrigeration solutions.

- Security, communication solutions, advanced digital signage technology, access control solutions, displays...

Panasonic R&D Center Germany GmbH.

The European Research and Development Center of Panasonic focusing on technology development for intelligent and environmentally friendly future products, such as audio video, communication and energy solutions.



ETHEREA

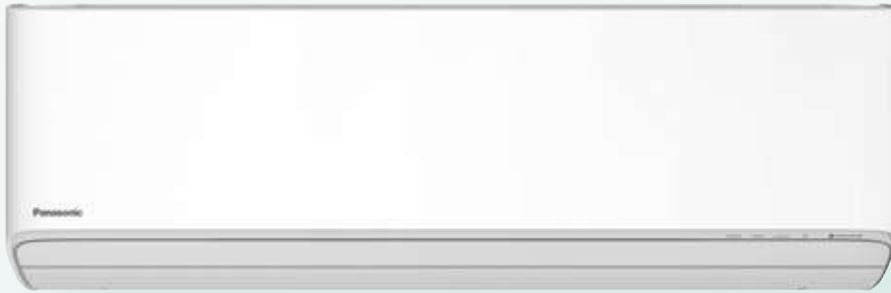

Panasonic domestic air to air heat pump

Panasonic has developed a range of products designed for you, better than ever before. Above all, it is also a range for air conditioning professionals, such as yourself, thanks to its broad range of products which are capable of conditioning rooms of all sizes – always with optimal efficiency and incomparable ease of installation.

Bringing nature's balance indoors → 16

Welcome to the connected world of Panasonic Comfort Cloud App → 17

Voice Control. Words do more than actions → 17

Domestic air conditioner R32 range → 18

Wall-mounted indoor units, designed for simple installation and maintenance → 20

Wall-mounted

BZ super-compact · R32 → 21

TZ super-compact · R32 → 22

Etherea · R32 → 24

More options for your home

Floor console · R32 → 26

Low static pressure hide-away · R32 → 27

Free Multi system → 28

Multi TZ system → 32

Compare solutions → 33

Control and connectivity → 34

Accessories and control → 35

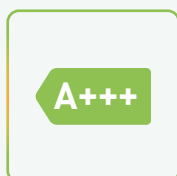
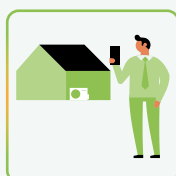

Bringing nature's balance indoors



nanoe™ X, technology with the benefits of hydroxyl radicals.

Abundant in nature, hydroxyl radicals (also known as OH radicals) have the capacity to inhibit pollutants, viruses, and bacteria to clean and deodorise. nanoe™ X technology can bring these incredible benefits indoors so that hard surfaces, soft furnishings, and the indoor environment can be a cleaner and more pleasant place to be.



nanoe™ X, improving protection 24/7







Actively cleans your air and inhibits certain types of pollutants all day long.

nanoe™ X works together with heating or cooling function when you are at home and can work independently when you are away. Give the air conditioning the strength to increase the protection at home with nanoe™ X technology and convenient control via the Panasonic Comfort Cloud App.



Panasonic's nanoe™ X technology takes this a step further and brings nature's detergent – hydroxyl radicals – indoors to help create an ideal environment

Thanks to the nanoe™ X properties, several types of pollutants can be inhibited such as certain types of bacteria, viruses, mould, allergens, pollen and certain hazardous substances.

Deodorises	Capacity to inhibit 5 types of pollutants					Moisturises
 Odours	 Bacteria and viruses	 Mould	 Allergens	 Pollen	 Hazardous substances	 Skin and hair

The nanoe™ X performance varies depending on the room size, environment and usage and it may take several hours to reach the full effect. nanoe™ X is not medical device, local regulations on building design and sanitary recommendations must be followed.

REFER TO PAGE 10 FOR MORE DETAILS AND VALIDATION DATA

Panasonic Heating & Cooling Solutions is incorporating nanoe™ technology in a wide range of equipment

Split and multi split. Built-in nanoe X Generator Mark 2.

-  **Wall-mounted Etherea XZ-H.**
CS-XZ**XKEW-H. 3 capacities: 2.0 - 3.5 kW.
-  **Wall-mounted Etherea XZ.**
CS-XZ**XKEW. 4 capacities: 2.0 - 5.0 kW.
-  **Wall-mounted Etherea Z.**
CS-(M)Z**XKEW. 7 capacities: 1.6 - 7.1 kW.

Floor console. Built-in nanoe X Generator Mark 1.

-  **Floor console.**
CS-Z**UFEAW.
3 capacities: 2,5 - 5,0 kW.

Welcome to the connected world of Panasonic Comfort Cloud App

Whether you are at home, at the office or running a business, Panasonic Comfort Cloud put total control of your indoor air quality at your fingertips.



1 Smart control

In control of cooling comfort anytime, anywhere.

- Control multiple units in 1 location (up to 20 units per location and up to 10 different locations)
- Control multiple units in multiple locations



The smartest way to bring convenience to your living space (living room, bedroom, study room...).



and business (spa, schools, restaurants...).

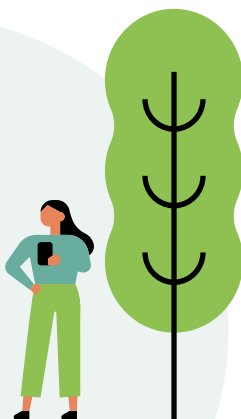

Download on the App Store



GET IT ON Google Play

2 Smart comfort

Easily manage your comfort and air quality.

- Remotely access all AC features
- Activate 24-hour nanoe™ X ¹⁾
- Pre-heat or cool spaces

3 Smart efficiency

More comfort with less wasted energy.

- Analyze energy usage patterns ²⁾
- Compare usage history for better budget planning

4 Smart assist

Be informed of breakdowns.

- Assign other users while you are away
- Effortless troubleshooting ³⁾

1) nanoe™ X is available in certain series. 2) Estimated energy consumption data accuracy depends on power supply quantity. 3) Contact trained technicians to perform any repairing / service.

Voice Control. Words do more than actions





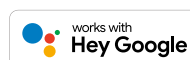



Control without boundaries and get hands-free help to fully access the features of your air conditioners. Maximising your cooling comfort is now a breeze with our Network-Enabled Air Conditioners with Panasonic Comfort Cloud App and Voice Control.

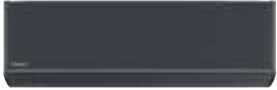

* Google, Android, Google Play and Google Home are trademarks of Google LLC. Amazon, Alexa and all related logos are trademarks of Amazon.com, Inc. or its affiliates. Availability of Voice Assistant services varies depending on Country and Language. More information about set up procedures: <https://aircon.panasonic.com/connectivity/application.html>. Google Home and Alexa are compatible with the models shown in pages 18, 19.











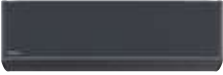

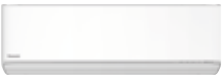



Domestic air conditioner R32 range

Page	Single split units	2.0 kW	2.5 kW	3.5 kW	4.2 kW	5.0 kW	6.0 kW	7.1 kW
	NEW Wall-mounted BZ super-compact Inverter · R32							
P. 21			CS-BZ25XKE CU-BZ25XKE	CS-BZ35XKE CU-BZ35XKE		CS-BZ50XKE CU-BZ50XKE	CS-BZ60XKE CU-BZ60XKE	
	Wall-mounted TZ super-compact Inverter · R32							
P. 22		CS-TZ20WKEW CU-TZ20WKE	CS-TZ25WKEW CU-TZ25WKE	CS-TZ35WKEW CU-TZ35WKE	CS-TZ42WKEW CU-TZ42WKE	CS-TZ50WKEW CU-TZ50WKE	CS-TZ60WKEW CU-TZ60WKE	CS-TZ71WKEW CU-TZ71WKE
	Wall-mounted Etherea Inverter+ · R32							
P. 24	 *	CS-XZ20XKEW-H CU-Z20XKE	CS-XZ25XKEW-H CU-Z25XKE	CS-XZ35XKEW-H CU-Z35XKE				
		CS-XZ20XKEW CU-Z20XKE	CS-XZ25XKEW CU-Z25XKE	CS-XZ35XKEW CU-Z35XKE		CS-XZ50XKEW CU-Z50XKE		
		CS-Z20XKEW CU-Z20XKE	CS-Z25XKEW CU-Z25XKE	CS-Z35XKEW CU-Z35XKE	CS-Z42XKEW CU-Z42XKE	CS-Z50XKEW CU-Z50XKE		CS-Z71XKEW CU-Z71XKE
	Floor console Inverter+ · R32							
P. 26			CS-Z25UFEAW CU-Z25UBEA	CS-Z35UFEAW CU-Z35UBEA		CS-Z50UFEAW CU-Z50UBEA		
	Low static pressure hide-away Inverter · R32							
P. 27			CS-Z25UD3EAW CU-Z25UBEA	CS-Z35UD3EAW CU-Z35UBEA		CS-Z50UD3EAW CU-Z50UBEA	CS-Z60UD3EAW CU-Z60UBEA	

* Available in Spring 22.



Configure in a few steps your Free Multi system with our online tool.

Page	Free Multi indoors	1.6 kW	2.0 kW	2.5 kW	3.5 kW	4.2 kW	5.0 kW	6.0 kW	7.1 kW
P. 31	Wall-mounted Etherea Inverter+								
		CS-XZ20XKEW-H CS-XZ25XKEW-H CS-XZ35XKEW-H							
		CS-XZ20XKEW CS-XZ25XKEW CS-XZ35XKEW			CS-XZ50XKEW				
P. 31	Wall-mounted TZ super-compact Inverter								
		CS-MTZ16WKE CS-TZ20WKEW CS-TZ25WKEW CS-TZ35WKEW CS-TZ42WKEW CS-TZ50WKEW CS-TZ60WKEW CS-TZ71WKEW							
		CS-MZ16XKE	CS-Z20XKEW	CS-Z25XKEW	CS-Z35XKEW	CS-Z42XKEW	CS-Z50XKEW	CS-Z71XKEW	
P. 31	Floor console Inverter+								
		CS-MZ20UFEA CS-Z25UFEAW CS-Z35UFEAW			CS-Z50UFEAW				
P. 31	NEW 4 Way 60x60 cassette Inverter								
		S-M20PY3E CZ-KPY4	S-25PY3E CZ-KPY4	S-36PY3E CZ-KPY4	S-50PY3E CZ-KPY4			S-60PY3E CZ-KPY4	
P. 31	Low static pressure hide-away Inverter								
		CS-MZ20UD3EA	CS-Z25UD3EAW	CS-Z35UD3EAW	CS-Z50UD3EAW			CS-Z60UD3EAW	
Page	Free Multi outdoors	3.2 ~ 6.0 kW	3.2 ~ 6.0 kW	3.2 ~ 7.7 kW	4.5 ~ 9.5 kW	4.5 ~ 11.2 kW	4.5 ~ 11.5 kW	4.5 ~ 14.7 kW	4.5 ~ 18.3 kW
P. 30	Outdoor unit Free Multi system Z · R32								
									
		CU-2Z35TBE	CU-2Z41TBE	CU-2Z50TBE	CU-3Z52TBE	CU-3Z68TBE	CU-4Z68TBE	CU-4Z80TBE	CU-5Z90TBE
Page	Multi Wall TZ outdoors	3.2 ~ 6.0 kW			3.2 ~ 7.7 kW		4.5 ~ 9.5 kW		
P. 32	Outdoor unit Multi TZ for wall TZ indoors · R32								
									
		CU-2TZ41TBE			CU-2TZ50TBE		CU-3TZ52TBE		

Wall-mounted indoor units, designed for simple installation and maintenance

The full range of wall-mounted indoor units has been carefully designed for simple, stress-free installation and ongoing maintenance.

* Not applicable to VZ.



1 Super-compact design

The compact design of the indoor units have a width of just 779 mm. This allows for more installation possibilities, including the limited space above a door.

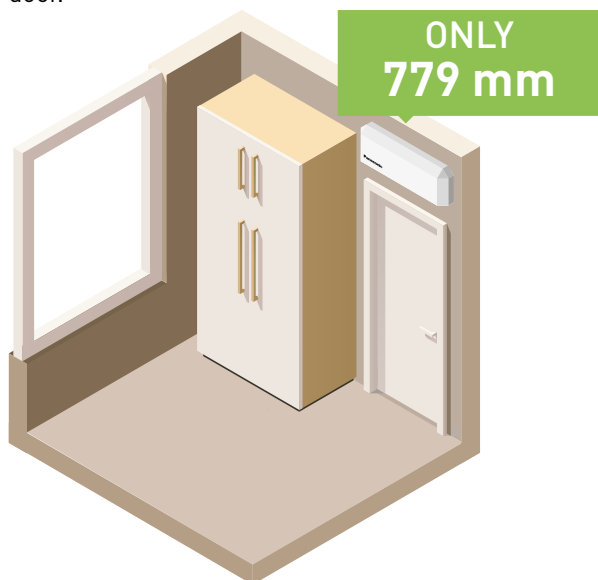

2 Simple installation

Thanks to advanced improvements, installation time has been dramatically decreased. The air conditioning models feature a reinforced installation plate, providing more stability and strength for a neatly fitted installation. With the newly built-in support, the unit is suitably designed for just one person to install. There is also a clear view and convenient access to the drain hose and cabling inserts. An increase of 13 mm has been achieved for piping so that installers can now easily ensure that the pipes and insulations are securely and neatly fitted.



3 Easy maintenance

Meticulously designed for both installer and user benefit, the unit features an easy to remove front grille for convenient access to the interior. The inner workings of the unit have also been redesigned to make maintenance quicker and easier. Electronics and wiring components are now on just one side of the unit to simplify maintenance.

4 Easy / hidden installation of the Wi-Fi adapter

The latest model features a dedicated space for a network adapter. Easy to plug in, the guided wire slots allow for clear, easy installation and can be neatly tucked away - simple and out of sight!



NEW Wall-mounted BZ super-compact Inverter · R32

- Compact design with only 779 mm wide
- Cleaner air with PM2.5 Filter
- Super Quiet! Only 20 dB(A)
- Aerowings to control air draft direction
- High energy savings
- Cooling even at -10 °C
- Optional internet and voice control

Kit			KIT-BZ25-XKE	KIT-BZ35-XKE	KIT-BZ50-XKE	KIT-BZ60-XKE
Cooling capacity	Nominal (Min - Max)	kW	2.50 (0.85 - 3.00)	3.40 (0.85 - 3.90)	5.00 (0.98 - 5.40)	6.00 (0.98 - 6.50)
UK cooling	Total - Sensible	kW	2.46 - 2.08	3.45 - 2.66	4.75 - 3.47	5.80 - 3.85
EER ¹⁾	Nominal (Min - Max)	W/W	3.68 (4.05 - 3.33)	3.18 (3.54 - 3.05)	3.03 (3.92 - 2.90)	3.03 (3.92 - 2.83)
SEER ²⁾			6.20 A++	6.10 A++	6.50 A++	6.30 A++
Pdesign (cooling)		kW	2.50	3.40	5.00	6.00
Input power	Nominal (Min - Max)	kW	0.68 (0.21 - 0.90)	1.07 (0.24 - 1.28)	1.65 (0.25 - 1.86)	1.98 (0.25 - 2.30)
Annual energy consumption ³⁾		kWh/a	141	195	269	333
Heating capacity	Nominal (Min - Max)	kW	3.15 (0.80 - 3.60)	3.84 (0.80 - 4.40)	5.40 (0.98 - 7.50)	6.80 (0.98 - 8.00)
UK heating	Total	kW	2.17	2.74	4.50	4.80
Heating capacity at -7 °C		kW	2.14	2.60	4.58	5.10
COP ¹⁾	Nominal (Min - Max)	W/W	4.06 (4.21 - 3.46)	3.69 (4.10 - 3.41)	3.42 (4.67 - 3.06)	3.16 (4.26 - 3.02)
SCOP ²⁾			4.20 A+	4.20 A+	4.10 A+	4.00 A+
Pdesign at -10 °C		kW	1.90	2.40	4.00	4.40
Input power	Nominal (Min - Max)	kW	0.78 (0.19 - 1.04)	1.04 (0.20 - 1.29)	1.58 (0.21 - 2.45)	2.15 (0.23 - 2.65)
Annual energy consumption ³⁾		kWh/a	633	800	1366	1540
Indoor unit			CS-BZ25XKE	CS-BZ35XKE	CS-BZ50XKE	CS-BZ60XKE
Power supply		V	230	230	230	230
Fuse size	Recommended / Max	A	10/16	10/16	13/16	16/20
Connection indoor / outdoor		mm	4 x 1.5	4 x 1.5	4 x 2.5	4 x 2.5
Air flow	Cool / Heat	m ³ /sec	0.18/0.19	0.18/0.19	0.21/0.22	0.21/0.23
Moisture removal volume		L/h	1.5	2.0	2.8	3.3
Sound pressure ⁴⁾	Cool (Hi / Lo / Q-Lo)	dB(A)	37/26/20	38/30/20	44/37/34	45/37/34
	Heat (Hi / Lo / Q-Lo)	dB(A)	37/27/24	38/33/25	44/37/34	45/37/34
Sound power	Cool - Heat	dB(A)	53 - 53	54 - 54	60 - 60	60 - 61
Dimension	H x W x D	mm	290 x 779 x 209	290 x 779 x 209	290 x 779 x 209	290 x 779 x 209
Net weight		kg	8	8	8	9
Outdoor unit			CU-BZ25XKE	CU-BZ35XKE	CU-BZ50XKE	CU-BZ60XKE
Air flow	Cool / Heat	m ³ /sec	0.51/0.51	0.52/0.52	0.55/0.55	0.71/0.69
Sound pressure ⁴⁾	Cool / Heat (Hi)	dB(A)	48/49	48/50	48/49	50/50
Dimension ⁵⁾	H x W x D	mm	542 x 780 x 289	542 x 780 x 289	619 x 824 x 299	695 x 875 x 320
Net weight		kg	24	25	36	43
Piping diameter	Liquid pipe	Inch (mm)	1/4 (6.35)	1/4 (6.35)	1/4 (6.35)	1/4 (6.35)
	Gas pipe	Inch (mm)	3/8 (9.52)	3/8 (9.52)	1/2 (12.70)	1/2 (12.70)
Pipe length range		m	3~15	3~15	3~15	3~30
Elevation difference (in / out)		m	15	15	15	15
Pipe length for additional gas		m	7.5	7.5	7.5	7.5
Additional gas amount		g/m	10	10	15	15
Refrigerant (R32) / CO ₂ Eq.		kg / T	0.54/0.36	0.67/0.45	1.14/0.77	1.11/0.75
Operating range	Cool Min ~ Max	°C	-10 ~ +43	-10 ~ +43	-10 ~ +43	-10 ~ +43
	Heat Min ~ Max	°C	-15 ~ +24	-15 ~ +24	-15 ~ +24	-15 ~ +24
Kit RRP		£	700	793	1.161	1.435
Indoor unit RRP		£	276	300	435	542
Outdoor unit RRP		£	424	493	726	893

1) EER and COP calculation is based in accordance to EN14511. 2) Energy Label Scale from A+++ to D. 3) The annual energy consumption is calculated in accordance to EU/626/2011. 4) The sound pressure of the indoor unit shows the value measured of a position of 1 m in front of the main body and 0.8 m below the unit. For outdoor unit 1 m in front and 1 m in rear side of main body. The sound pressure is measured in accordance with JIS C 9612. Q-Lo: Quiet mode. Lo: The lowest set fan speed. 5) Add 70 mm for piping port.

Accessories		RRP £
CZ-TACG1	Wi-Fi adapter for smart control via Panasonic Comfort Cloud App	114
CZ-CAPRA1	RAC interface adapter for integration into P-Link	163

Accessories		RRP £
CZ-RD517C	Wired remote controller for wall-mounted and floor console	144



SEER and SCOP: For KIT-BZ50-XKE. SUPER QUIET: For KIT-BZ25-XKE and KIT-BZ35-XKE. INTERNET CONTROL: Optional.

Rating Conditions: Cooling Indoor 27 °C DB / 19 °C WB. Cooling Outdoor 35 °C DB / 24 °C WB. Heating Indoor 20 °C DB. Heating Outdoor 7 °C DB / 6 °C WB. (DB: Dry Bulb; WB: Wet Bulb). Specifications subject to change without notice. For detailed information about ErP / Energy Labelling, please visit our websites www.panasonic.co.uk/aircon or www.ptc.panasonic.eu.

Wall-mounted TZ super-compact

The perfect air conditioner for the smallest spaces in your home.
TZ with R32 refrigerant powerful and efficient.



**GOOD DESIGN
AWARD 2020**

An "excellent design" indicated by Good Design Award is a design which focusses on humanity, honesty, innovation, aesthetics and ethics. Panasonic's award-winning TZ proves to be a worthy addition to any home.

1 Super-compact design

The compact design of the indoor units have a width of just 779 mm. This allows for more installation possibilities, including the limited space above a door.

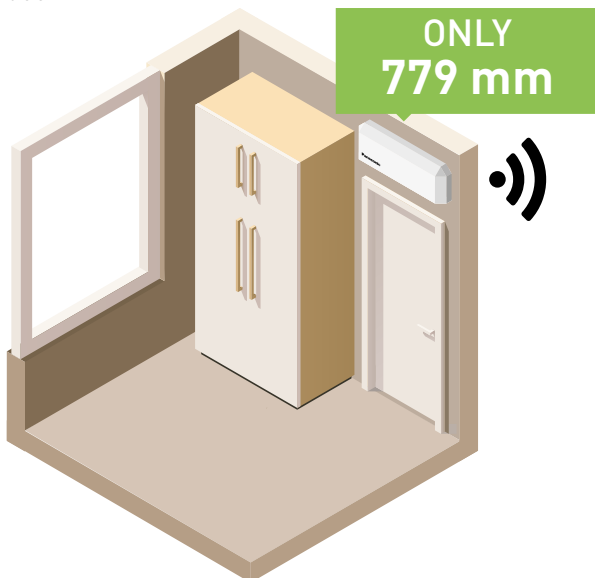

2 Built-in Wi-Fi and compatible with Voice Assistant

The unit is ready to connect to the internet and to be controlled by smartphone with Panasonic Comfort Cloud App. Control, monitor, and schedule with easy interface.

By connecting Panasonic Comfort Cloud App the unit can be managed by Google Assistant and Amazon Alexa*.

* Amazon, Alexa and all related logos are trademarks of Amazon.com, Inc. or its affiliates. Google, Android, Google Play and Google Home are trademarks of Google LLC.

3 PM2.5

Particulate matter (PM2.5) can be found suspended in the air, including dust, dirt, smoke and liquid droplets. The filter can catch PM2.5 particles including hazardous pollutants as well as house dust and pollen and is able to maintain the air quality of the room.

4 Stylish infrared control

Enjoy innovative design at your fingertips with the new stylish and sleek Backlit Sky Controller. Bigger screen and easier to use.

Silent ambient and relaxing atmosphere 20 dB(A)

We have succeeded in making one of the most silent air conditioners on the market. Panasonic Inverter air conditioner's indoor operating noise has been reduced as the Inverter constantly varies its output power to enable more precise temperature control.

* KIT-TZ20-WKE, KIT-TZ25-WKE and KIT-TZ35-WKE: In the Quiet Mode during cooling operation with low fan speed.

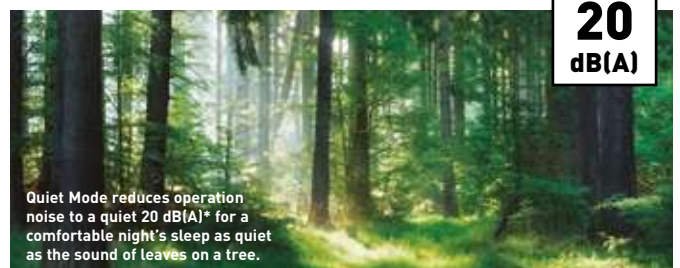

Quiet Mode reduces operation noise to a quiet 20 dB(A)* for a comfortable night's sleep as quiet as the sound of leaves on a tree.



**GOOD DESIGN
AWARD 2020**



Wall-mounted TZ super-compact · R32

- Compact and elegant design with only 779 mm wide
- Built-in Wi-Fi for instant connectivity via Panasonic Comfort Cloud App
- Compatible with Google Assistant and Amazon Alexa
- Stylish Sky remote controller
- Cleaner air with PM2.5 filter
- Super Quiet! Only 20 dB(A)
- Aerowings to control air draft direction
- High energy savings

Kit			KIT-TZ20-WKE	KIT-TZ25-WKE	KIT-TZ35-WKE	KIT-TZ42-WKE	KIT-TZ50-WKE	KIT-TZ60-WKE	KIT-TZ71-WKE
Cooling capacity	Nominal (Min - Max)	kW	2.00 [0.75 - 2.40]	2.50 [0.85 - 3.00]	3.50 [0.85 - 3.90]	4.20 [0.85 - 4.60]	5.00 [0.98 - 5.60]	6.00 [0.98 - 6.60]	7.10 [0.98 - 8.20]
UK cooling	Total - Sensible	kW	1.98 - 1.72	2.48 - 2.09	3.47 - 2.65	4.17 - 2.87	4.97 - 3.83	5.90 - 4.47	7.00 - 4.80
EER ¹⁾	Nominal (Min - Max)	W/W	4.08 [4.17 - 4.00]	3.85 [4.05 - 3.41]	3.57 [3.62 - 3.36]	3.36 [3.62 - 2.80]	3.13 [3.92 - 2.95]	3.24 [3.92 - 2.87]	3.17 [2.33 - 2.98]
SEER²⁾			7.00 A++	7.00 A++	6.80 A++	6.40 A++	6.90 A++	6.80 A++	6.20 A++
Pdesign (cooling)		kW	2.00	2.50	3.50	4.20	5.00	6.00	7.10
Input power	Nominal (Min - Max)	kW	0.49 [0.18 - 0.60]	0.65 [0.21 - 0.88]	0.98 [0.24 - 1.16]	1.25 [0.24 - 1.64]	1.60 [0.25 - 1.90]	1.85 [0.25 - 2.30]	2.24 [0.42 - 2.75]
Annual energy consumption ³⁾		kWh/a	100	125	180	230	254	309	401
Heating capacity	Nominal (Min - Max)	kW	2.70 [0.70 - 3.60]	3.30 [0.80 - 4.10]	4.00 [0.80 - 5.10]	5.00 [0.80 - 6.80]	5.80 [0.98 - 7.50]	7.00 [0.98 - 8.20]	8.60 [0.98 - 9.90]
UK heating	Total	kW	2.21	2.47	3.18	3.43	4.55	5.00	5.34
Heating capacity at -7 °C		kW	2.14	2.70	3.30	3.90	4.62	4.90	6.13
COP ¹⁾	Nominal (Min - Max)	W/W	4.15 [4.24 - 3.53]	4.18 [4.21 - 3.66]	4.04 [4.10 - 3.70]	3.73 [4.10 - 3.33]	3.41 [4.67 - 3.26]	3.68 [4.67 - 3.57]	3.51 [2.45 - 3.47]
SCOP²⁾			4.60 A++	4.60 A++	4.60 A++	4.00 A+	4.50 A+	4.30 A+	4.00 A+
Pdesign at -10 °C		kW	1.90	2.40	2.80	3.60	4.00	4.40	5.50
Input power	Nominal (Min - Max)	kW	0.65 [0.17 - 1.02]	0.79 [0.19 - 1.12]	0.99 [0.20 - 1.38]	1.34 [0.20 - 2.04]	1.70 [0.21 - 2.30]	1.90 [0.21 - 2.30]	2.45 [0.40 - 2.85]
Annual energy consumption ³⁾		kWh/a	578	730	852	1260	1244	1433	1925
Indoor unit			CS-TZ20WKEW	CS-TZ25WKEW	CS-TZ35WKEW	CS-TZ42WKEW	CS-TZ50WKEW	CS-TZ60WKEW	CS-TZ71WKEW
Power supply		V	230	230	230	230	230	230	230
Fuse size	Recommended / Max	A	10/16	10/16	10/16	13/16	13/16	16/20	20/20
Connection indoor / outdoor		mm ²	4x1.5	4x1.5	4x1.5	4x1.5	4x2.5	4x2.5	4x2.5
Air flow	Cool / Heat	m ³ /sec	0.17/0.18	0.18/0.19	0.20/0.21	0.21/0.22	0.21/0.22	0.35/0.37	0.37/0.38
Moisture removal volume		L/h	1.3	1.5	2.0	2.4	2.8	3.3	4.1
Sound pressure ⁴⁾	Cool (Hi / Lo / Q-Lo)	dB(A)	37/25/20	40/26/20	42/30/20	44/31/29	44/37/33	45/37/34	47/38/35
	Heat (Hi / Lo / Q-Lo)	dB(A)	38/26/22	40/27/22	42/33/22	44/35/28	44/37/33	45/37/34	47/38/35
Sound power	Cool - Heat	dB(A)	53 - 54	56 - 56	58 - 58	60 - 60	60 - 60	60 - 61	63 - 63
Dimension	H x W x D	mm	290 x 779 x 209	290 x 779 x 209	290 x 779 x 209	290 x 779 x 209	290 x 779 x 209	302 x 1102 x 244	302 x 1102 x 244
Net weight		kg	8	8	8	8	8	13	13
Outdoor unit			CU-TZ20WKE	CU-TZ25WKE	CU-TZ35WKE	CU-TZ42WKE	CU-TZ50WKE	CU-TZ60WKE	CU-TZ71WKE
Air flow	Cool / Heat	m ³ /sec	0.50/0.50	0.50/0.48	0.48/0.50	0.51/0.51	0.55/0.55	0.57/0.57	0.75/0.77
Sound pressure ⁴⁾	Cool / Heat (Hi)	dB(A)	46/47	47/48	48/50	49/51	48/49	49/51	52/54
Dimension ⁵⁾	H x W x D	mm	542 x 780 x 289	542 x 780 x 289	542 x 780 x 289	542 x 780 x 289	619 x 824 x 299	619 x 824 x 299	695 x 875 x 320
Net weight		kg	24	25	31	31	36	36	50
Piping diameter	Liquid pipe	Inch (mm)	1/4 [6.35]	1/4 [6.35]	1/4 [6.35]	1/4 [6.35]	1/4 [6.35]	1/4 [6.35]	1/4 [6.35]
	Gas pipe	Inch (mm)	3/8 [9.52]	3/8 [9.52]	3/8 [9.52]	1/2 [12.70]	1/2 [12.70]	1/2 [12.70]	5/8 [15.88]
Pipe length range		m	3~15	3~15	3~15	3~15	3~20	3~30	3~30
Elevation difference (in / out)		m	15	15	15	15	15	15	20
Pipe length for additional gas		m	7.5	7.5	7.5	7.5	7.5	10	10
Additional gas amount		g/m	10	10	10	10	15	15	25
Refrigerant (R32) / CO ₂ Eq.		kg / T	0.54/0.365	0.67/0.452	0.77/0.520	0.79/0.533	1.14/0.770	1.22/0.824	1.32/0.891
Operating range	Cool Min ~ Max	°C	-10 ~ +43	-10 ~ +43	-10 ~ +43	-10 ~ +43	-10 ~ +43	-10 ~ +43	-10 ~ +43
	Heat Min ~ Max	°C	-15 ~ +24	-15 ~ +24	-15 ~ +24	-15 ~ +24	-15 ~ +24	-15 ~ +24	-15 ~ +24
Kit RRP		£	798	920	1.066	1.272	1.358	1.679	1.902
Indoor unit RRP		£	326	364	404	461	504	721	837
Outdoor unit RRP		£	472	556	662	811	854	958	1.065

1) EER and COP calculation is based in accordance to EN14511. 2) Energy Label Scale from A+++ to D. 3) The annual energy consumption is calculated in accordance to EU/626/2011. 4) The sound pressure of the indoor unit shows the value measured at a position of 1 m in front of the main body and 0.8 m below the unit. For outdoor unit 1 m in front and 1 m in rear side of main body. The sound pressure is measured in accordance with JIS C 9612. Q-Lo: Quiet mode. Lo: The lowest set fan speed. 5) Add 70 mm for piping port.

Accessories		RRP £
CZ-CAPRA1	RAC interface adapter for integration into P-Link	163

Accessories		RRP £
CZ-RD517C	Wired remote controller for wall-mounted and floor console	144



SEER and SCOP: For KIT-TZ20-WKE and KIT-TZ25-WKE. SUPER QUIET: For KIT-TZ20-WKE, KIT-TZ25-WKE and KIT-TZ35-WKE. INTERNET CONTROL: Built-in Wi-Fi.

Rating Conditions: Cooling Indoor 27 °C DB / 19 °C WB. Cooling Outdoor 35 °C DB / 24 °C WB. Heating Indoor 20 °C DB. Heating Outdoor 7 °C DB / 6 °C WB. [DB: Dry Bulb; WB: Wet Bulb]. Specifications subject to change without notice. For detailed information about ErP / Energy Labelling, please visit our websites www.panasonic.co.uk/aircon or www.ptc.panasonic.eu.

Etherea: Welcome to your new home

ETHEREA

The Etherea with nanoe™ X technology improves protection 24/7. With a new sleek design, an outstanding efficiency A+++, advanced smart control that allows to connect with voice assistant, Aerowings 2.0 for the ultimate comfort and designed to allow for simple installation and easy maintenance.

Available in 3 colors.



- 1 nanoe™ X technology to improve protection 24/7**
This advanced technology utilises hydroxyl radicals (also known as OH radicals), which inhibit the growth of certain pollutants such as allergens, bacteria, viruses, moulds, odours, and certain hazardous substances. This naturally occurring process has major benefits indoors and improves the protection inside a room 24/7.

The nanoe™ X performance varies depending on the room size, environment and usage and it may take several hours to reach the full effect (see page 10 for more detail). nanoe™ X is not medical device, local regulations on building design and sanitary recommendations must be followed.



- 2 Sleek design with easy-to-use remote controller**
Panasonic has meticulously designed a new chassis for the Etherea indoor unit for a sleek and stylish solution to blend with any interior. Its elegant monolithic design is robust and allows for a high-performance air conditioner, with a large air discharge area to optimal performance. The new controller intuitive design provides easy operation with five quick access keys for convenient use.



- 3 Advanced smart control and voice assistant**
The Etherea is compatible with Panasonic Comfort Cloud App, which is designed to manage all functions of the systems with a smart device. Control, monitor, and schedule with easy interface. Through the Panasonic Comfort Cloud App, Etherea units can also be connected to Google Assistant and Amazon Alexa*.

* Amazon, Alexa and all related logos are trademarks of Amazon.com, Inc. or its affiliates. Google, Android, Google Play and Google Home are trademarks of Google LLC.

- 4 The ultimate comfort with high energy savings**
Etherea produces the highest level of comfort thanks to Aerowings 2.0, creating a pleasant environment in any setting, with a low energy cost.



nanoe™X

Wall-mounted Etherea Inverter+ · R32

- nanoe™ X technology to improve protection 24/7
- New sleek and stylish design, in Matt white, Silver and Graphite grey color
- Improved SEER / SCOP to achieve top class energy efficiency
- Aerowings 2.0 for the ultimate comfort
- New easy-to-use remote controller
- Built-in Wi-Fi for instant connectivity via Panasonic Comfort Cloud App
- Compatible with Google Assistant and Amazon Alexa
- Chassis and parts designed for easier installation

New Kit Graphite grey*			KIT-XZ20-XKE-H	KIT-XZ25-XKE-H	KIT-XZ35-XKE-H	—	—	—
Kit Silver			KIT-XZ20-XKE	KIT-XZ25-XKE	KIT-XZ35-XKE	—	KIT-XZ50-XKE	—
Kit Matt white			KIT-Z20-XKE	KIT-Z25-XKE	KIT-Z35-XKE	KIT-Z42-XKE	KIT-Z50-XKE	KIT-Z71-XKE
Cooling capacity	Nominal (Min - Max)	kW	2.05 [0.75 - 2.65]	2.50 [0.85 - 3.50]	3.50 [0.85 - 4.20]	4.20 [0.85 - 5.00]	5.00 [0.98 - 6.00]	7.10 [0.98 - 8.50]
UK cooling	Total - Sensible	kW	2.09 - 1.76	2.58 - 2.17	3.47 - 2.91	4.25 - 3.57	4.7 - 3.95	6.68 - 5.61
EER ¹⁾	Nominal (Min - Max)	W/W	4.56 [4.69 - 3.96]	4.90 [5.00 - 3.89]	4.12 [4.25 - 3.62]	3.39 [3.62 - 3.18]	3.68 [3.92 - 3.16]	3.17 [2.33 - 2.83]
SEER²⁾			8.10 A++	9.40 A+++	9.50 A+++	7.00 A++	8.50 A+++	6.50 A++
Pdesign [cooling]		kW	2.1	2.5	3.5	4.2	5.0	7.1
Input power	Nominal (Min - Max)	kW	0.45 [0.16 - 0.67]	0.51 [0.17 - 0.90]	0.85 [0.20 - 1.16]	1.24 [0.24 - 1.57]	1.36 [0.25 - 1.90]	2.24 [0.42 - 3.00]
Annual energy consumption ³⁾		kWh/a	91	93	129	210	206	382
Heating capacity	Nominal (Min - Max)	kW	2.80 [0.75 - 4.00]	3.40 [0.80 - 4.80]	4.00 [0.80 - 5.50]	5.30 [0.80 - 6.80]	5.80 [0.98 - 8.00]	8.20 [0.98 - 10.20]
UK heating	Total	kW	2.78	3.32	3.81	4.74	5.57	7.15
Heating capacity at -7 °C		kW	2.38	2.80	3.20	4.11	4.80	6.31
COP ¹⁾	Nominal (Min - Max)	W/W	4.52 [4.69 - 4.26]	4.86 [5.00 - 4.07]	4.44 [4.44 - 3.77]	3.68 [4.21 - 3.66]	4.14 [4.26 - 3.35]	3.69 [2.45 - 3.29]
SCOP²⁾			4.80 A++	5.20 A+++	5.20 A+++	4.20 A+	4.80 A++	4.20 A+
Pdesign at -10 °C		kW	2.1	2.4	2.8	3.6	4.2	5.5
Input power	Nominal (Min - Max)	kW	0.62 [0.16 - 0.94]	0.70 [0.16 - 1.18]	0.90 [0.18 - 1.46]	1.44 [0.19 - 1.86]	1.40 [0.23 - 2.39]	2.22 [0.40 - 3.10]
Annual energy consumption ³⁾		kWh/a	613	646	754	1200	1225	1833
Indoor unit Graphite grey			CS-XZ20XKEW-H	CS-XZ25XKEW-H	CS-XZ35XKEW-H	—	—	—
Indoor unit Silver			CS-XZ20XKEW	CS-XZ25XKEW	CS-XZ35XKEW	—	CS-XZ50XKEW	—
Indoor unit Matt white			CS-Z20XKEW	CS-Z25XKEW	CS-Z35XKEW	CS-Z42XKEW	CS-Z50XKEW	CS-Z71XKEW
Power supply		V	230	230	230	230	230	230
Fuse size	Recommended / Max	A	10/16	10/16	10/16	13/16	16/16	20/20
Connection indoor / outdoor		mm ²	4x1.5	4x1.5	4x1.5	4x1.5	4x2.5	4x2.5
Air flow	Cool / Heat	m ³ /sec	0.20/0.22	0.21/0.24	0.21/0.25	0.24/0.26	0.29/0.32	0.32/0.33
Moisture removal volume		L/h	1.3	1.5	2.0	2.4	2.8	4.1
Sound pressure ⁴⁾	Cool (Hi / Lo / Q-Lo)	dB(A)	37/24/19	39/25/19	42/28/19	43/31/25	44/37/30	47/38/30
	Heat (Hi / Lo / Q-Lo)	dB(A)	38/25/19	41/27/19	43/33/19	43/35/29	44/37/30	47/38/30
Sound power	Cool - Heat	dB(A)	53 - 54	55 - 57	58 - 59	59 - 59	60 - 60	63 - 63
Dimension	H x W x D	mm	295x870x229	295x870x229	295x870x229	295x870x229	295x1040x244	295x1040x244
Net weight		kg	10	10	11	10	12	14
nanoe X Generator			Mark 2	Mark 2	Mark 2	Mark 2	Mark 2	Mark 2
Outdoor unit			CU-Z20XKE	CU-Z25XKE	CU-Z35XKE	CU-Z42XKE	CU-Z50XKE	CU-Z71XKE
Air flow	Cool / Heat	m ³ /sec	0.46/0.45	0.48/0.45	0.50/0.51	0.50/0.52	0.66/0.62	0.75/0.76
Sound pressure ⁴⁾	Cool / Heat (Hi)	dB(A)	45/46	46/47	48/50	49/51	47/47	52/54
Dimension ⁵⁾	H x W x D	mm	542x780x289	542x780x289	542x780x289	542x780x289	695x875x320	695x875x320
Net weight		kg	25	27	30	30	40	50
Piping diameter	Liquid pipe	Inch (mm)	1/4 (6.35)	1/4 (6.35)	1/4 (6.35)	1/4 (6.35)	1/4 (6.35)	1/4 (6.35)
	Gas pipe	Inch (mm)	3/8 (9.52)	3/8 (9.52)	3/8 (9.52)	1/2 (12.70)	1/2 (12.70)	5/8 (15.88)
Pipe length range		m	3-15	3-15	3-15	3-15	3-30	3-30
Elevation difference (in / out)		m	15	15	15	15	15	20
Pipe length for additional gas		m	7.5	7.5	7.5	7.5	7.5	10
Additional gas amount		g/m	10	10	10	10	15	25
Refrigerant (R32) / CO ₂ Eq.		kg / T	0.67/0.45	0.80/0.54	0.89/0.60	0.95/0.64	1.13/0.76	1.35/0.91
Operating range	Cool Min ~ Max	°C	-10 ~ +43	-10 ~ +43	-10 ~ +43	-10 ~ +43	-10 ~ +43	-10 ~ +43
	Heat Min ~ Max	°C	-15 ~ +24	-15 ~ +24	-15 ~ +24	-15 ~ +24	-15 ~ +24	-15 ~ +24
Kit Graphite grey RRP		£	1.128	1.238	1.379	—	—	—
Indoor unit Graphite grey RRP		£	384	466	531	—	—	—
Kit Silver RRP		£	1.093	1.195	1.330	—	1.528	—
Indoor unit Silver RRP		£	349	423	482	—	784	—
Kit Matt white RRP		£	1.066	1.166	1.286	1.514	1.753	2.533
Indoor unit Matt white RRP		£	322	394	438	468	627	988
Outdoor unit RRP		£	744	772	848	1.046	1.126	1.545

1) EER and COP calculation is based in accordance to EN14511. 2) Energy Label Scale from A+++ to D. 3) The annual energy consumption is calculated in accordance to EU/626/2011. 4) The sound pressure of the indoor unit shows the value measured of a position of 1 m in front of the main body and 0.8 m below the unit. For outdoor unit 1 m in front and 1 m in rear side of main body. The sound pressure is measured in accordance with JIS C 9612. Q-Lo: Quiet mode. Lo: The lowest set fan speed. 5) Add 70 mm for piping port. * Available in Spring 22.

Accessories		RRP £
CZ-CAPRA1	RAC interface adapter for integration into P-Link	163
PAW-SMSCONTROL	Control by SMS (need additional SIM card)	280

Accessories		RRP £
CZ-RD517C	Wired remote controller for wall-mounted and floor console	144



SEER and SCOP: For KIT-**35-XKE. SUPER QUIET: For KIT-**20-XKE, KIT-**25-XKE, KIT-**35-XKE. INTERNET CONTROL: Built-in Wi-Fi.

Rating Conditions: Cooling Indoor 27 °C DB / 19 °C WB. Cooling Outdoor 35 °C DB / 24 °C WB. Heating Indoor 20 °C DB. Heating Outdoor 7 °C DB / 6 °C WB. [DB: Dry Bulb; WB: Wet Bulb]. Specifications subject to change without notice. For detailed information about ErP / Energy Labelling, please visit our websites www.panasonic.co.uk/aircon or www.ptc.panasonic.eu.



Floor console Inverter+ · R32

- nanoe™ X technology to improve protection 24/7 (nanoe X Generator Mark 1)
- Stylish Sky remote controller
- A breakthrough design that integrates perfectly with the most modern environments
- High energy efficiency class A++ SEER and A++ SCOP
- Optional internet and voice control

Kit			KIT-Z25-UFE	KIT-Z35-UFE	KIT-Z50-UFE
Cooling capacity	Nominal (Min - Max)	kW	2.50 (0.85 - 3.40)	3.50 (0.85 - 3.80)	5.00 (0.90 - 5.70)
UK cooling	Total - Sensible	kW	2.36 - 2.19	3.31 - 2.84	4.73 - 3.48
EER ¹⁾	Nominal (Min - Max)	W/W	4.81 (3.54 - 3.78)	4.07 (3.54 - 3.73)	3.60 (3.53 - 3.15)
SEER ²⁾			7.90 A++	8.10 A++	6.70 A++
Pdesign (cooling)		kW	2.50	3.50	5.00
Input power	Nominal (Min - Max)	kW	0.52 (0.24 - 0.90)	0.86 (0.24 - 1.02)	1.39 (0.26 - 1.81)
Annual energy consumption ³⁾		kWh/a	111	151	261
Heating capacity	Nominal (Min - Max)	kW	3.40 (0.85 - 5.00)	4.30 (0.85 - 6.00)	5.80 (0.90 - 8.10)
UK heating	Total	kW	3.46	4.13	5.68
Heating capacity at -7 °C		kW	2.88	3.37	5.03
COP ¹⁾	Nominal (Min - Max)	W/W	4.47 (3.54 - 3.70)	3.98 (3.54 - 3.43)	3.74 (3.46 - 3.12)
SCOP ²⁾			4.60 A++	4.60 A++	4.30 A+
Pdesign at -10 °C		kW	2.70	3.20	4.40
Input power	Nominal (Min - Max)	kW	0.76 (0.24 - 1.35)	1.08 (0.24 - 1.75)	1.55 (0.26 - 2.60)
Annual energy consumption ³⁾		kWh/a	822	974	1433
Indoor unit			CS-Z25UFEAW	CS-Z35UFEAW	CS-Z50UFEAW
Air flow	Cool / Heat	m ³ /sec	0.16/0.17	0.17/0.17	0.19/0.22
Moisture removal volume		L/h	1.5	2.0	2.8
Sound pressure ⁴⁾	Cool (Hi / Lo / Q-Lo)	dB(A)	38/25/20	39/26/20	44/31/27
	Heat (Hi / Lo / Q-Lo)	dB(A)	38/25/19	39/26/19	46/33/29
Sound power	Cool / Heat	dB(A)	54 / 54	55 / 55	60 / 62
Dimension	HxWxD	mm	600x750x207	600x750x207	600x750x207
Net weight		kg	13	13	13
nanoe X Generator			Mark 1	Mark 1	Mark 1
Outdoor unit			CU-Z25UBEA	CU-Z35UBEA	CU-Z50UBEA
Power supply		V	230	230	230
Fuse size	Recommended / Max	A	10/13	10/13	16/13
Connection indoor / outdoor		mm ²	—	—	—
Air flow	Cool / Heat	m ³ /sec	0.48/0.45	0.57/0.56	0.66/0.64
Sound pressure ⁴⁾	Cool / Heat (Hi)	dB(A)	46/47	48/48	48/48
Dimension ⁵⁾	HxWxD	mm	542x780x289	619x824x299	695x875x320
Net weight		kg	33	35	43
Piping diameter	Liquid pipe	Inch (mm)	1/4 (6.35)	1/4 (6.35)	1/4 (6.35)
	Gas pipe	Inch (mm)	3/8 (9.52)	3/8 (9.52)	1/2 (12.70)
Pipe length range		m	3~20	3~20	3~30
Elevation difference (in / out)		m	15	15	20
Pipe length for additional gas		m	7.5	7.5	7.5
Additional gas amount		g/m	10	10	15
Refrigerant (R32) / CO ₂ Eq.		kg / T	0.88/0.594	0.93/0.628	1.13/0.763
Operating range	Cool Min ~ Max	°C	-10 ~ +43	-10 ~ +43	-10 ~ +43
	Heat Min ~ Max	°C	-15 ~ +24	-15 ~ +24	-15 ~ +24
Kit RRP		£	1.472	1.587	1.926
Indoor unit RRP		£	775	841	995
Outdoor unit RRP		£	697	746	931

1) EER and COP calculation is based in accordance to EN14511. 2) Energy Label Scale from A+++ to D. 3) The annual energy consumption is calculated in accordance to EU/626/2011. 4) The sound pressure of the units shows the value measured of a position 1 m in front of the main body and 1 m above floor. The sound pressure is measured in accordance with JIS C 9612. Q-Lo: Quiet mode. Lo: The lowest set fan speed. 5) Add 70 mm for piping port.

Accessories		RRP £
CZ-TACG1	Wi-Fi adapter for smart control via Panasonic Comfort Cloud App	114
CZ-CAPRA1	RAC interface adapter for integration into P-Link	163

Accessories		RRP £
CZ-RD517C	Wired remote controller for wall-mounted and floor console	144



SEER and SCOP: For KIT-Z35-UFE. SUPER QUIET: For KIT-Z25-UFE and KIT-Z35-UFE. INTERNET CONTROL: Optional. IF DESIGN AWARD 2019: Floor console awarded with the prestigious IF Design Award 2019.



MORE DUCT TYPE SOLUTIONS IN PACI SECTION



Optional wireless control kit. CZ-RL511D



Low static pressure hide-away Inverter - R32

- Duct type can be controlled by KNX and Modbus
- Eco mode for 20 % energy saving
- Extremely compact indoor units without losing static pressure (only 200 mm high)
- Weekly timer, 42 settings per week
- Easy check mode for failure detection
- Drain pump included

Kit			KIT-Z25-UD3	KIT-Z35-UD3	KIT-Z50-UD3	KIT-Z60-UD3
Cooling capacity	Nominal (Min - Max)	kW	2.50 [0.85 - 3.20]	3.50 [0.85 - 4.00]	5.10 [0.90 - 5.70]	6.00 [0.90 - 6.50]
UK cooling	Total - Sensible	kW	2.30 - 2.29	3.09 - 2.77	3.63 - 2.92	4.25 - 3.42
EER ¹⁾	Nominal (Min - Max)	W/W	4.31 [3.54 - 3.76]	3.85 [3.54 - 3.36]	3.27 [3.53 - 3.20]	2.94 [3.53 - 2.83]
SEER ²⁾			5.90 A+	5.80 A+	5.90 A+	5.60 A+
Pdesign (cooling)		kW	2.50	3.50	5.10	6.00
Input power	Nominal (Min - Max)	kW	0.58 [0.24 - 0.85]	0.91 [0.24 - 1.19]	1.56 [0.26 - 1.78]	2.04 [0.26 - 2.30]
Annual energy consumption ³⁾		kWh/a	148	211	303	375
Heating capacity	Nominal (Min - Max)	kW	3.20 [0.85 - 4.60]	4.20 [0.85 - 5.10]	6.10 [0.90 - 7.20]	7.00 [0.90 - 8.00]
UK heating	Total	kW	3.17	3.54	5.06	5.64
Heating capacity at -7 °C		kW	2.60	3.00	4.50	5.10
COP ¹⁾	Nominal (Min - Max)	W/W	4.00 [3.70 - 3.68]	3.82 [3.70 - 3.59]	3.35 [3.46 - 3.27]	3.24 [3.46 - 3.08]
SCOP ²⁾			4.20 A+	4.10 A+	4.10 A+	4.10 A+
Pdesign at -10 °C		kW	2.60	2.80	4.00	4.60
Input power	Nominal (Min - Max)	kW	0.80 [0.23 - 1.25]	1.10 [0.23 - 1.42]	1.82 [0.26 - 2.20]	2.16 [0.26 - 2.60]
Annual energy consumption ³⁾		kWh/a	867	956	1366	1571
Indoor unit			CS-Z25UD3EAW	CS-Z35UD3EAW	CS-Z50UD3EAW	CS-Z60UD3EAW
External static pressure ⁴⁾	Min - Max	Pa	15 - 45	15 - 45	15 - 50	15 - 50
Air flow	Cool / Heat	m ³ /sec	0.18/0.18	0.19/0.19	0.26/0.26	0.26/0.26
Moisture removal volume		L/h	1.5	2.0	2.8	3.3
Sound pressure ⁵⁾	Cool (Hi / Lo / Q-Lo)	dB(A)	33/27/24	33/27/24	39/29/26	41/30/27
	Heat (Hi / Lo / Q-Lo)	dB(A)	35/27/24	35/27/24	39/30/27	41/32/29
Sound power	Cool - Heat	dB(A)	49 - 51	49 - 51	55 - 55	57 - 57
Dimension	H x W x D	mm	200 x 750 x 640	200 x 750 x 640	200 x 750 x 640	200 x 750 x 640
Net weight		kg	19	19	19	19
Outdoor unit			CU-Z25UBEA	CU-Z35UBEA	CU-Z50UBEA	CU-Z60UBEA
Power supply		V	230	230	230	230
Fuse size	Recommended / Max	A	10/16	10/16	13/16	16/16
Connection indoor / outdoor		mm ²	4 x 1.5 - 2.5	4 x 1.5 - 2.5	4 x 1.5 - 2.5	—
Air flow	Cool / Heat	m ³ /sec	0.48/0.45	0.57/0.56	0.66/0.64	0.71/0.69
Sound pressure ⁵⁾	Cool / Heat (Hi)	dB(A)	46/47	48/48	48/48	49/50
Dimension ⁶⁾	H x W x D	mm	542 x 780 x 289	619 x 824 x 299	695 x 875 x 320	695 x 875 x 320
Net weight		kg	33	35	43	43
Piping diameter	Liquid pipe	Inch (mm)	1/4 (6.35)	1/4 (6.35)	1/4 (6.35)	1/4 (6.35)
	Gas pipe	Inch (mm)	3/8 (9.52)	3/8 (9.52)	1/2 (12.70)	1/2 (12.70)
Pipe length range		m	3 - 20	3 - 20	3 - 30	3 - 30
Elevation difference (in / out)		m	15	15	20	20
Pipe length for additional gas		m	7.5	7.5	7.5	7.5
Additional gas amount		g/m	10	10	15	15
Refrigerant (R32) / CO ₂ Eq.		kg / T	0.88/0.594	0.93/0.628	1.13/0.763	1.13/0.763
Operating range	Cool Min ~ Max	°C	-10 ~ +43	-10 ~ +43	-10 ~ +43	-10 ~ +43
	Heat Min ~ Max	°C	-15 ~ +24	-15 ~ +24	-15 ~ +24	-15 ~ +24
Kit RRP		£	1.436	1.519	1.959	2.161
Indoor unit RRP		£	739	773	1.028	1.073
Outdoor unit RRP		£	697	746	931	1.088

1) EER and COP calculation is based in accordance to EN14511. 2) Energy Label Scale from A+++ to D. 3) The annual energy consumption is calculated in accordance to EU/626/2011. 4) The specification listed on the table indicates values under the condition of 25 Pa (2.5 mmAq) which are applied for factory default setting. Change switch on PCB from Hi to S-Hi to have more than 6.0 mmAq. 5) The sound pressure of the indoor unit shows the value measured of a position of 1.5 m below the unit with 1 m duct on the suction side and 2 m duct on the discharge side. For outdoor unit 1 m in front and 1 m in rear side of main body. The sound pressure is measured in accordance with JIS C 9612. 6) Add 100 mm for indoor unit or 70 mm for outdoor unit for piping port.

Accessories		RRP £
CZ-TACG1	Wi-Fi adapter for smart control via Panasonic Comfort Cloud App	114

Accessories		RRP £
CZ-CAPRA1	RAC interface adapter for integration into P-Link	163
CZ-RL511D	Optional wireless control kit	105



SEER and SCOP: For KIT-Z25-UD3. INTERNET CONTROL: Optional.

Rating Conditions: Cooling Indoor 27 °C DB / 19 °C WB. Cooling Outdoor 35 °C DB / 24 °C WB. Heating Indoor 20 °C DB. Heating Outdoor 7 °C DB / 6 °C WB. (DB: Dry Bulb; WB: Wet Bulb). Specifications subject to change without notice. For detailed information about ErP / Energy Labelling, please visit our websites www.panasonic.co.uk/aircon or www.ptc.panasonic.eu.

Free Multi system

If air conditioning requirements exceed the scope of a single room, Panasonic offers an extensive range of possibilities with a multi split solution.



Panasonic offers widest range in multi split systems

The multi split solution offers high flexibility, as 2 to 5 indoor units can be connected to a single outdoor unit. The wide range of compatible indoor units includes Etherea and TZ wall-mounted units, floor console, 4 way 60x60 cassette and low static pressure hide-away.

Full flexibility up to 9.0 kW and up to 5 ports with wide range of indoor units including high performance Etherea indoor units, reaching up to A+++ / A++.

Line up	Multi Z	
Capacities	8 units (3.5 ~ 9.0 kW)	
Indoor unit ports	2~5	
Efficiency up to	A+++ / A++	
Indoor units	Etherea	Yes
	TZ super-compact	Yes
	Floor console	Yes
	Cassette	Yes
	Hide-away	Yes

Why a multi split is better than several separate split units

Up to 5 indoor units with a single outdoor unit.

- Just one compact outdoor unit
- Increased comfort in the house since every room has its own indoor unit for heating or cooling
- Much more powerful than a single split

- More efficient since the units are always operating at full capacity
- You can connect all types of indoor units, such as wall types and consoles, depending on what suits your house best

Solution with single split.

One indoor unit is connected to one outdoor unit. The indoor unit is placed in the main hallway and heats the entire house. Certain rooms may not be perfectly heated, which causes inadequate comfort.

1. Laundry room. 2. Entrance. 3. Kitchen / dining area. 4. Bathroom. 5. Living room. 6. Bedroom.

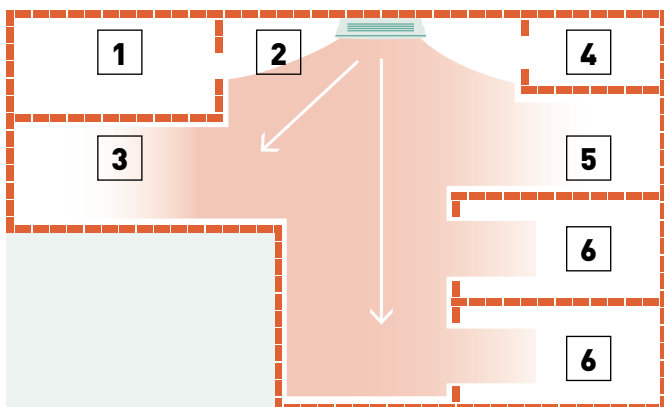

Solution with multi split.

With one outdoor unit, you can connect up to five indoor units. There is one indoor unit per room or area. It gives an extreme increase in comfort levels. On the roof, there is only one outdoor unit.

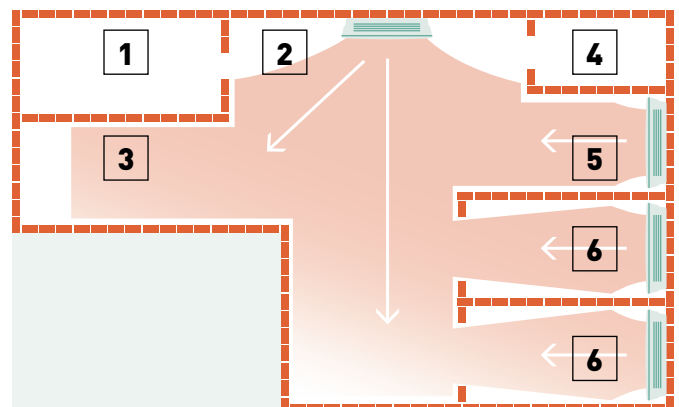

Configure in a few steps your Free Multi system with our online tool.



Outdoor unit Free Multi system Z · R32

- Up to 5 indoor units with a single outdoor unit
- Up to 5 rooms with individual control
- Etherea, floor console and 4 way 60x60 cassette with nanoe™ X technology to improve protection 24/7
- Wide choice of indoor units to adapt to each room
- High energy efficiency class A+++ SEER
- Flexible installation, compact units and large connection distance
- Indoor units compatible with internet and voice control



Outdoor unit			CU-2Z35TBE	CU-2Z41TBE	CU-2Z50TBE	CU-3Z52TBE	CU-3Z68TBE	CU-4Z68TBE	CU-4Z80TBE	CU-5Z90TBE
Indoor nominal capacity (Min - Max)			3.2~6.0 kW	3.2~6.0 kW	3.2~7.7 kW	4.5~9.5 kW	4.5~11.2 kW	4.5~11.5 kW	4.5~14.7 kW	4.5~18.3 kW
Cooling capacity	Nominal	kW	3.50	4.10	5.00	5.20	6.80	6.80	8.00	9.00
	Min		1.50	1.50	1.50	1.80	1.90	1.90	3.00	2.90
	Max		4.50	5.20	5.40	7.30	8.00	8.80	9.20	11.50
EER ¹⁾	Nominal	W/W	4.86	4.56	4.24	4.77	3.66	4.39	4.04	4.09
	Min		6.00	6.00	6.00	—	7.04	5.59	5.66	5.27
	Max		4.09	3.80	3.62	—	3.38	3.56	3.21	2.98
SEER ²⁾			8.50 A+++	8.50 A+++	8.50 A+++	8.50 A+++	8.00 A++	8.00 A++	7.90 A++	8.50 A+++
Pdesign (cooling)		kW	3.50	4.10	5.00	5.20	6.80	6.80	8.00	9.00
Input power	Nominal	kW	0.72	0.90	1.18	1.09	1.86	1.55	1.98	2.20
	Min		0.25	0.25	0.25	0.36	0.27	0.34	0.53	0.55
	Max		1.10	1.37	1.49	2.18	2.37	2.47	2.87	3.86
Annual energy consumption ³⁾		kWh/a	144	169	206	214	298	298	990	1100
Heating capacity	Nominal	kW	4.20	4.60	5.60	6.80	8.50	8.50	9.40	10.40
	Min		1.10	1.10	1.10	1.60	3.30	3.00	4.20	3.40
	Max		5.60	7.00	7.20	8.30	10.40	10.60	10.60	14.50
Heating capacity at -7 °C		kW	—	—	—	3.95	4.45	4.45	—	—
COP ¹⁾	Nominal	W/W	4.88	4.79	4.63	4.63	3.95	4.47	4.63	4.84
	Min		5.24	5.24	5.24	5.00	5.32	5.17	6.00	6.42
	Max		4.18	3.91	4.00	3.82	3.64	3.96	3.46	3.42
SCOP ²⁾			4.60 A++	4.60 A++	4.60 A++	4.20 A+	4.20 A+	4.20 A+	4.70 A++	4.68 A++
Pdesign at -10 °C		kW	3.20	3.50	4.20	5.00	5.20	5.80	6.80	8.50
Input power	Nominal	kW	0.86	0.96	1.21	1.47	2.15	1.90	2.03	2.15
	Min		0.21	0.21	0.21	0.32	0.62	0.58	0.70	0.53
	Max		1.34	1.79	1.80	2.17	2.86	2.68	3.06	4.24
Annual energy consumption ³⁾		kWh/a	974	1065	1278	1667	1733	1933	2026	2543
Current	Cool / Heat	A	3.35/4.00	4.15/4.45	5.35/5.50	5.00/6.70	8.40/9.70	7.00/8.60	9.50/9.50	10.50/10.10
Power supply		V	230	230	230	230	230	230	230	230
Suggested fuse		A	16	16	16	16	16	20	20	25
Recommended power cable section		mm ²	2.5	2.5	2.5	2.5	2.5	2.5	2.5	4.0
Sound pressure ⁴⁾	Cool / Heat (Hi)	dB(A)	48/50	48/50	50/52	47/48	51/52	49/50	51/52	53/54
Dimension ⁵⁾	HxWxD	mm	619x824x299	619x824x299	619x824x299	795x875x320	795x875x320	795x875x320	999x940x340	999x940x340
Net weight		kg	39	39	39	71	71	72	80	81
Piping diameter	Liquid pipe	Inch (mm)	1/4 (6.35)	1/4 (6.35)	1/4 (6.35)	1/4 (6.35)	1/4 (6.35)	1/4 (6.35)	1/4 (6.35)	1/4 (6.35)
	Gas pipe	Inch (mm)	3/8 (9.52)	3/8 (9.52)	3/8 (9.52)	3/8 (9.52)	3/8 (9.52)	3/8 (9.52)	3/8 (9.52)	3/8 (9.52)
Pipe length range total ⁶⁾		m	6~30	6~30	6~30	6~50	6~60	6~60	6~70	6~80
Pipe length range to one unit		m	3~20	3~20	3~20	3~25	3~25	3~25	3~25	3~25
Elevation difference (in / out)		m	10	10	10	15	15	15	15	15
Pipe length for additional gas		m	20	20	20	30	30	30	45	45
Additional gas amount		g/m	15	15	15	20	20	20	20	20
Refrigerant (R32) / CO ₂ Eq.		kg / T	1.12/0.756	1.12/0.756	1.12/0.756	2.10/1.418	2.10/1.418	2.10/1.418	2.72/1.836	2.72/1.836
Operating range	Cool Min ~ Max	°C	-10~+46	-10~+46	-10~+46	-10~+46	-10~+46	-10~+46	-10~+46	-10~+46
	Heat Min ~ Max	°C	-15~+24	-15~+24	-15~+24	-15~+24	-15~+24	-15~+24	-15~+24	-15~+24
Outdoor unit RRP		£	1.122	1.275	1.447	1.745	2.021	2.264	2.843	3.339

1) EER and COP calculation is based in accordance to EN14511. 2) Energy Label Scale from A+++ to D. 3) The annual energy consumption is calculated in accordance to EU/626/2011. 4) The sound pressure of the units shows the value measured at a position 1 m in front and 1 m in rear side of the main body. The sound pressure is measured in accordance with JIS C 9612. 5) Add 70 or 95 mm for piping port. 6) Minimum piping length is 3 meters per indoor unit.

Possible outdoor / indoor units combinations

Rooms	Model	Indoor capacity connected (Min - Max)	Wall-mounted Etherea							Wall-mounted TZ super-compact							Floor console				4 Way 60x60 cassette					Low static pressure hide-away											
			16	20	25	35	42	50	71	16	20	25	35	42	50	60	71	20	25	35	50	20	25	35	50	60	20	25	35	50	60						
2	CU-2Z35TBE	3.2~6.0 kW	•	•	•	•					•	•	•	•							• ¹⁾	• ¹⁾	• ¹⁾				•	•	•								
	CU-2Z41TBE	3.2~6.0 kW	•	•	•	•					•	•	•	•								• ¹⁾	• ¹⁾	• ¹⁾				•	•	•							
	CU-2Z50TBE	3.2~7.7 kW	•	•	•	•	• ¹⁾	• ¹⁾			•	•	•	•	• ¹⁾	• ¹⁾						• ¹⁾	• ¹⁾	• ¹⁾	• ¹⁾			•	•	•	• ¹⁾	• ¹⁾					
3	CU-3Z52TBE	4.5~9.5 kW	•	•	•	•	• ¹⁾	• ¹⁾			•	•	•	•	• ¹⁾	• ¹⁾						• ¹⁾	• ¹⁾	• ¹⁾	• ¹⁾			•	•	•	• ¹⁾	• ¹⁾					
	CU-3Z68TBE	4.5~11.2 kW	•	•	•	•	• ¹⁾	• ¹⁾			•	•	•	•	• ¹⁾	• ¹⁾						• ¹⁾	• ¹⁾	• ¹⁾	• ¹⁾	• ²⁾		•	•	•	• ¹⁾	• ¹⁾	• ¹⁾	• ¹⁾	• ¹⁾	• ¹⁾	• ²⁾
4	CU-4Z68TBE	4.5~11.5 kW	•	•	•	•	• ¹⁾	• ¹⁾			•	•	•	•	• ¹⁾	• ¹⁾						• ¹⁾	• ¹⁾	• ¹⁾	• ¹⁾	• ²⁾		•	•	•	• ¹⁾	• ¹⁾	• ¹⁾	• ¹⁾	• ¹⁾	• ¹⁾	• ²⁾
	CU-4Z80TBE	4.5~14.7 kW	•	•	•	•	• ¹⁾	• ¹⁾	• ³⁾		•	•	•	•	• ¹⁾	• ¹⁾	• ²⁾					• ¹⁾	• ¹⁾	• ¹⁾	• ¹⁾	• ²⁾		•	•	•	• ¹⁾	• ¹⁾	• ¹⁾	• ¹⁾	• ¹⁾	• ¹⁾	• ²⁾
5	CU-5Z90TBE	4.5~18.3 kW	•	•	•	•	• ¹⁾	• ¹⁾	• ³⁾		•	•	•	•	• ¹⁾	• ¹⁾	• ²⁾	• ³⁾				• ¹⁾	• ¹⁾	• ¹⁾	• ¹⁾	• ²⁾		•	•	•	• ¹⁾	• ¹⁾	• ¹⁾	• ¹⁾	• ¹⁾	• ¹⁾	• ²⁾

1) Pipe reducer CZ-MA1PA required. 2) Pipe reducer CZ-MA2PA required. 3) Pipe reducers CZ-MA2PA and CZ-MA3PA required.





Optional wired remote controller. CZ-RD517C

INTERNET CONTROL: Built-in Wi-Fi.



Wall-mounted Etherea	Indoor unit Graphite grey*	Indoor unit Silver	Indoor unit Matt white	Cooling capacity	Heating capacity	Connection in. / out.	Sound pressure ¹⁾		Dimension / Net weight	Piping diameter	Silver RRP	Silver RRP	White RRP
							Cool — Heat (Hi/Lo/S-Lo)						
							kW	kW	mm ²	dB(A)	mm / kg	Liquid / Gas pipe	£
1.6 kW	—	—	CS-MZ16XKE	1.60	2.60	4 x 1.5	38/26/21 — 39/27/21	295 x 870 x 229/10	1/4(6.35)/3/8(9.52)	—	—	305	
2.0 kW	CS-XZ20XKEW-H	CS-XZ20XKEW	CS-Z20XKEW	2.00	3.20	4 x 1.5	39/26/21 — 40/27/21	295 x 870 x 229/10	1/4(6.35)/3/8(9.52)	384	349	322	
2.5 kW	CS-XZ25XKEW-H	CS-XZ25XKEW	CS-Z25XKEW	2.50	3.60	4 x 1.5	41/27/21 — 43/29/21	295 x 870 x 229/10	1/4(6.35)/3/8(9.52)	466	423	394	
3.5 kW ²⁾	CS-XZ35XKEW-H	CS-XZ35XKEW	CS-Z35XKEW	3.50	4.50	4 x 1.5	44/30/21 — 45/35/21	295 x 870 x 229/11	1/4(6.35)/3/8(9.52)	531	482	438	
4.2 kW ³⁾	—	—	CS-Z42XKEW	4.20	5.60	4 x 1.5	44/33/27 — 45/37/31	295 x 870 x 229/10	1/4(6.35)/1/2(12.70)	—	—	468	
5.0 kW ⁴⁾	—	CS-XZ50XKEW	CS-Z50XKEW	5.00	6.80	4 x 2.5	44/39/32 — 46/39/32	295 x 1040 x 244/12	1/4(6.35)/1/2(12.70)	—	784	627	
7.1 kW	—	—	CS-Z71XKEW	7.10	8.70	4 x 2.5	49/40/32 — 49/40/32	295 x 1040 x 244/14	1/4(6.35)/5/8(15.88)	—	—	988	



Optional wired remote controller. CZ-RD517C

INTERNET CONTROL: Built-in Wi-Fi.



Wall-mounted TZ super-compact	Indoor unit	Cooling capacity	Heating capacity	Connection in. / out.	Sound pressure ¹⁾		Dimension / Net weight	Piping diameter	RRP
					Cool — Heat (Hi/Lo/S-Lo)				
					kW	kW	mm ²	dB(A)	mm / kg
1.6 kW	CS-MTZ16WKE	1.60	2.60	4 x 1.5	38/27/22 — 39/28/24	290 x 779 x 209/8	1/4(6.35)/3/8(9.52)	294	
2.0 kW	CS-TZ20WKEW	2.00	2.70	4 x 1.5	37/25/20 — 38/26/22	290 x 779 x 209/8	1/4(6.35)/3/8(9.52)	326	
2.5 kW	CS-TZ25WKEW	2.50	3.30	4 x 1.5	40/26/20 — 40/27/22	290 x 779 x 209/8	1/4(6.35)/3/8(9.52)	364	
3.5 kW ²⁾	CS-TZ35WKEW	3.50	4.00	4 x 1.5	42/30/20 — 42/33/22	290 x 779 x 209/8	1/4(6.35)/3/8(9.52)	404	
4.2 kW	CS-TZ42WKEW	4.20	5.00	4 x 1.5	44/31/29 — 44/35/34	290 x 779 x 209/8	1/4(6.35)/1/2(12.70)	461	
5.0 kW	CS-TZ50WKEW	5.00	5.80	4 x 2.5	44/37/33 — 44/37/33	290 x 779 x 209/8	1/4(6.35)/1/2(12.70)	504	
6.0 kW	CS-TZ60WKEW	6.00	7.00	4 x 2.5	45/37/34 — 45/37/34	302 x 1102 x 244/13	1/4(6.35)/1/2(12.70)	721	
7.1 kW	CS-TZ71WKEW	7.10	8.60	4 x 2.5	47/38/35 — 47/38/35	302 x 1102 x 244/13	1/4(6.35)/5/8(15.88)	837	



Optional wired remote controller. CZ-RD517C

INTERNET CONTROL: Optional.



Floor console ⁵⁾	Indoor unit	Cooling capacity	Heating capacity	Connection in. / out.	Sound pressure ⁶⁾		Dimension / Net weight	Piping diameter	RRP
					Cool — Heat (Hi/Lo/S-Lo)				
					kW	kW	mm ²	dB(A)	mm / kg
2.0 kW	CS-MZ20UFEA	2.00	3.20	4 x 1.5	39/27/22 — 39/27/21	600 x 750 x 207/13	1/4(6.35)/3/8(9.52)	622	
2.5 kW	CS-Z25UFEAW	2.50	3.60	4 x 1.5	40/27/22 — 40/27/21	600 x 750 x 207/13	1/4(6.35)/3/8(9.52)	775	
3.5 kW ²⁾	CS-Z35UFEAW	3.50	4.50	4 x 1.5	41/28/22 — 41/28/21	600 x 750 x 207/13	1/4(6.35)/3/8(9.52)	841	
5.0 kW	CS-Z50UFEAW	5.00	5.30	4 x 1.5	44/33/29 — 48/35/31	600 x 750 x 207/13	1/4(6.35)/1/2(12.70)	995	



Optional wired remote controller. CZ-RTC6



Panel (sold separately). CZ-KPY4

INTERNET CONTROL and BMS CONNECTIVITY: Optional.



NEW 4 Way 60x60 cassette*	Indoor unit (Panel CZ-KPY4)	Cooling capacity	Heating capacity	Connection in. / out.	Sound pressure ⁷⁾		Dimension / Net weight	Piping diameter	Indoor RRP	Panel RRP
					Cool — Heat (Hi/Lo/S-Lo)					
					kW	kW	mm ²	dB(A)	mm / kg	Liquid / Gas pipe
2.0 kW	S-M20PY3E	2.00	3.20	4 x 1.5	33/30/27 — 33/30/27	243 x 575 x 575/15	30 x 625 x 625/2.8	1/4(6.35)/1/2(12.70)	565	233
2.5 kW	S-25PY3E	2.50	3.60	4 x 1.5	33/30/27 — 33/30/27	243 x 575 x 575/15	30 x 625 x 625/2.8	1/4(6.35)/1/2(12.70)	655	233
3.5 kW ²⁾	S-36PY3E	3.50	3.60	4 x 1.5	36/32/27 — 36/32/27	243 x 575 x 575/15	30 x 625 x 625/2.8	1/4(6.35)/1/2(12.70)	694	233
5.0 kW ⁴⁾	S-50PY3E	5.00	6.80	4 x 1.5	41/36/29 — 41/36/29	243 x 575 x 575/15	30 x 625 x 625/2.8	1/4(6.35)/1/2(12.70)	787	233
6.0 kW	S-60PY3E	6.00	8.50	4 x 1.5	45/39/33 — 45/39/33	243 x 575 x 575/15	30 x 625 x 625/2.8	3/8(9.52)/5/8(15.88)	961	233

* Compatible with Commercial control and connectivity accessories only. For detailed information go to the control systems section.



Optional wireless control kit. CZ-RL511D

INTERNET CONTROL and BMS CONNECTIVITY: Optional.



Low static pressure hide-away	Indoor unit	Cooling capacity	Heating capacity	Connection in. / out.	Sound pressure ⁸⁾		Dimension / Net weight	Piping diameter	RRP
					Cool — Heat (Hi/Lo/S-Lo)				
					kW	kW	mm ²	dB(A)	mm / kg
2.0 kW	CS-MZ20UD3EA	2.00	3.20	4 x 1.5	34/29/26 — 36/29/26	200 x 750 x 640/19	1/4(6.35)/3/8(9.52)	612	
2.5 kW	CS-Z25UD3EAW	2.50	3.60	4 x 1.5	35/29/26 — 37/29/26	200 x 750 x 640/19	1/4(6.35)/3/8(9.52)	739	
3.5 kW ²⁾	CS-Z35UD3EAW	3.50	4.50	4 x 1.5	35/29/26 — 37/29/26	200 x 750 x 640/19	1/4(6.35)/3/8(9.52)	773	
5.0 kW ⁴⁾	CS-Z50UD3EAW	5.00	6.80	4 x 1.5	41/31/28 — 41/32/29	200 x 750 x 640/19	1/4(6.35)/1/2(12.70)	1.028	
6.0 kW	CS-Z60UD3EAW	6.00	8.50	4 x 1.5	43/32/29 — 43/34/31	200 x 750 x 640/19	1/4(6.35)/1/2(12.70)	1.073	

1) The sound pressure of the indoor unit shows the value measured of a position of 1 m in front of the main body and 0.8 m below the unit. The sound pressure is measured in accordance with JIS C 9612. Q-Lo: Quiet mode. Lo: The lowest set fan speed. 2) Heating capacity in combination with Free Multi outdoor units except with CU-Z235TBE. In this case, the heating capacity is 4.20 kW. 3) Heating capacity in combination with Free Multi outdoor units except with CU-Z250TBE. In this case, the heating capacity is 5.00 kW. 4) Heating capacity in combination with Free Multi outdoor units except with CU-Z235TBE. In this case, the heating capacity is 5.30 kW. 5) Compatible only with 2 ports R32 outdoor CU-Z235TBE / CU-Z241TBE / CU-Z250TBE. Minimum quantity of connection: 2 indoor units. 6) The sound pressure of the units shows the value measured of a position 1 m in front of the main body and 1 m above floor. The sound pressure is measured in accordance with JIS C 9612. Q-Lo: Quiet mode. Lo: The lowest set fan speed. 7) The sound pressure of the indoor unit shows the value measured of a position of 1.5 m below the unit. The sound pressure is measured in accordance with JIS C 9612. Q-Lo: Quiet mode. Lo: The lowest set fan speed. 8) The sound pressure of the indoor unit shows the value measured of a position of 1.5 m below the unit with 1 m duct on the suction side and 2 m duct on the discharge side. The sound pressure is measured in accordance with JIS C 9612. * Available in Spring 22.

Rating Conditions: Cooling Indoor 27 °C DB / 19 °C WB. Cooling Outdoor 35 °C DB / 24 °C WB. Heating Indoor 20 °C DB. Heating Outdoor 7 °C DB / 6 °C WB. [DB: Dry Bulb; WB: Wet Bulb]. Specifications subject to change without notice. For detailed information about ErP / Energy Labelling, please visit our websites www.panasonic.co.uk/aircon or www.ptc.panasonic.eu.

Multi TZ system

Outdoor unit Multi TZ · R32

- Up to 3 indoor units with a single outdoor unit
- Up to 3 rooms with individual control
- High energy efficiency class A++ SEER
- Flexible installation, compact units and large connection distance
- Indoor units compatible with internet and voice control



Outdoor unit			CU-2TZ41TBE	CU-2TZ50TBE	CU-3TZ52TBE
Indoor nominal capacity (Min - Max)			3.2 ~ 6.0 kW	3.2 ~ 7.7 kW	4.5 ~ 9.5 kW
Cooling capacity	Nominal (Min - Max)	kW	4.10 (1.50 - 4.70)	5.00 (1.50 - 5.40)	5.20 (1.80 - 6.60)
EER ¹⁾	Nominal (Min - Max)	W/W	4.14 (5.56 - 3.41)	3.85 (5.56 - 3.33)	4.52 (3.67 - 5.00)
SEER ²⁾			7.10 A++	7.00 A++	7.60 A++
Pdesign (cooling)		kW	4.10	5.00	5.20
Input power	Nominal (Min - Max)	kW	0.99 (0.27 - 1.38)	1.30 (0.27 - 1.62)	1.15 (0.36 - 1.80)
Annual energy consumption ³⁾		kWh/a	202	250	239
Heating capacity	Nominal (Min - Max)	kW	4.40 (1.10 - 6.30)	5.70 (1.10 - 6.40)	6.80 (1.60 - 7.50)
Heating capacity at -7 °C		kW	—	—	—
COP ¹⁾	Nominal (Min - Max)	W/W	4.44 (5.00 - 3.54)	4.35 (5.00 - 3.62)	4.28 (3.87 - 5.00)
SCOP ²⁾			4.30 A+	4.20 A+	4.20 A+
Pdesign at -10 °C		kW	3.50	4.50	5.00
Input power	Nominal (Min - Max)	kW	0.99 (0.22 - 1.78)	1.31 (0.22 - 1.77)	1.59 (0.32 - 1.94)
Annual energy consumption ³⁾		kWh/a	1139	1500	1667
Current	Cool / Heat	A	4.60 / 4.60	6.00 / 6.00	5.30 / 7.30
Power supply		V	230	230	230
Sound pressure ⁴⁾	Cool / Heat (Hi)	dB(A)	48 / 50	50 / 52	48 / 48
Dimension ⁵⁾	H x W x D	mm	542 x 780 x 289	542 x 780 x 289	795 x 875 x 320
Net weight		kg	35	35	71
Piping diameter	Liquid pipe	Inch (mm)	1/4 (6.35)	1/4 (6.35)	1/4 (6.35)
	Gas pipe	Inch (mm)	3/8 (9.52)	3/8 (9.52)	3/8 (9.52)
Pipe length range total		m	6 ~ 30	6 ~ 30	6 ~ 50
Pipe length range to one unit		m	3 ~ 20	3 ~ 20	3 ~ 25
Elevation difference (in / out)		m	10	10	15
Pipe length for additional gas		m	20	20	30
Additional gas amount		g/m	15	15	20
Refrigerant (R32) / CO ₂ Eq.		kg / T	0.9 / 0.6075	0.9 / 0.6075	2.1 / 1.4175
Operating range	Cool Min ~ Max	°C	-10 ~ +46	-10 ~ +46	-10 ~ +46
	Heat Min ~ Max	°C	-15 ~ +24	-15 ~ +24	-15 ~ +24
Outdoor unit RRP		€	1.123	1.277	1.540

1) EER and COP calculation is based in accordance to EN14511. 2) Energy Label Scale from A+++ to D. 3) The annual energy consumption is calculated in accordance to EU/626/2011. 4) The sound pressure of the units shows the value measured of a position 1 m in front and 1 m in rear side of the main body. The sound pressure is measured in accordance with JIS C 9612. 5) Add 70 or 95 mm for piping port.



Possible outdoor / indoor units combinations

Rooms	Model	Indoor capacity connected (Min - Max)	Wall-mounted TZ super-compact					
			16	20	25	35	42	50
2	CU-2TZ41TBE	3.2 ~ 6.0 kW	✓	✓	✓	✓		
	CU-2TZ50TBE	3.2 ~ 7.7 kW	✓	✓	✓	✓	✓	✓
3	CU-3TZ52TBE	4.5 ~ 9.5 kW	✓	✓	✓	✓	✓	✓

Minimum quantity of connection: 2 indoor units.















Optional wired remote controller. CZ-RD517C



Wall-mounted TZ super-compact	Indoor unit	Cooling capacity	Heating capacity	Connection in. / out.	Sound pressure ¹⁾		Dimension / Net weight	Piping diameter	RRP
					Cool — Heat (Hi/Lo/S-Lo)	dB(A)			
		kW	kW	mm ²			H x W x D	Liquid / Gas pipe	€
							mm / kg	Inch (mm)	
1.6 kW	CS-MTZ16WKE	1.60	2.60	4 x 1.5	38 / 27 / 22 — 39 / 28 / 24		290 x 779 x 209 / 8	1/4 (6.35) / 3/8 (9.52)	294
2.0 kW	CS-TZ20WKEW	2.00	2.70	4 x 1.5	37 / 25 / 20 — 38 / 26 / 22		290 x 779 x 209 / 8	1/4 (6.35) / 3/8 (9.52)	326
2.5 kW	CS-TZ25WKEW	2.50	3.30	4 x 1.5	40 / 26 / 20 — 40 / 27 / 22		290 x 779 x 209 / 8	1/4 (6.35) / 3/8 (9.52)	364
3.5 kW	CS-TZ35WKEW	3.50	4.00	4 x 1.5	42 / 30 / 20 — 42 / 33 / 22		290 x 779 x 209 / 8	1/4 (6.35) / 3/8 (9.52)	404
4.2 kW	CS-TZ42WKEW	4.20	5.00	4 x 1.5	44 / 31 / 29 — 44 / 35 / 34		290 x 779 x 209 / 8	1/4 (6.35) / 1/2 (12.70)	461
5.0 kW	CS-TZ50WKEW	5.00	5.80	4 x 2.5	44 / 37 / 33 — 44 / 37 / 33		290 x 779 x 209 / 8	1/4 (6.35) / 1/2 (12.70)	504

1) The sound pressure of the indoor unit shows the value measured of a position of 1 m in front of the main body and 0.8 m below the unit. The sound pressure is measured in accordance with JIS C 9612. Q-Lo: Quiet mode. Lo: The lowest set fan speed.

Compare solutions

			Indoor unit dimension	Efficiency ¹⁾	Indoor air quality		Comfort		Connectivity
Wall-mounted BZ super-compact	Matte white	2.5 to 6.0 kW	290 x 779 x 209	A++ A+	PM2.5 Filter	-10 °C in cooling mode -15 °C in heating mode	Aerowings	 20 dB(A)	Optional Wi-Fi CZ-TACG1
									
Wall-mounted TZ super-compact	Matte white	2.0 to 7.1 kW	290 x 779 x 209 (295 x 1040 x 244 wide model)	A++ A++	PM2.5 Filter	-10 °C in cooling mode -15 °C in heating mode	Aerowings	 20 dB(A)	Built-in Wi-Fi
									
Wall-mounted Etherea	Graphite grey / Silver / Matt white	2.0 to 7.1 kW	295 x 870 x 229 (295 x 1040 x 244 wide model)	A+++ A+++	 nanoex nano X Generator Mark 2	-10 °C in cooling mode -15 °C in heating mode	Aerowings 2.0	 19 dB(A)	Built-in Wi-Fi
 									
Floor console	White	2.5 to 5.0 kW	600 x 750 x 207	A++ A++	 nanoex nano X Generator Mark 1	-10 °C in cooling mode -15 °C in heating mode	Double air flow	 20 dB(A)	Optional Wi-Fi CZ-TACG1
									
Low static pressure hide-away		2.5 to 6.0 kW	200 x 750 x 640	A+ A+	Air filter	-10 °C in cooling mode -15 °C in heating mode		 24 dB(A)	Optional Wi-Fi CZ-TACG1
									

1) Energy efficiency class in 2.5 kW references. * All data in this chart is applicable in most of the models in each line up, check product specifications to confirm.

Control and connectivity

Panasonic offers its customers cutting-edge technology, specially designed to ensure our air conditioning systems deliver even higher performance. You can properly manage the air conditioning and perform comprehensive monitoring and control, with all of the features the remote controller provides at home, from anywhere in the world thanks to the internet applications Panasonic has created for you.

Domestic integration to P-Link - CZ-CAPRA1

Can connect RAC range to P-Link. Full control is now possible.

Integrates any unit in big system control.

- YKEA server room integration ¹⁾
- Small offices with domestic indoors
- Tender for refurbishment (old system Domestic and VRF in one installation)

1) When duty rotation using the remote controller is set up, CZ-CAPRA1 cannot be connected.

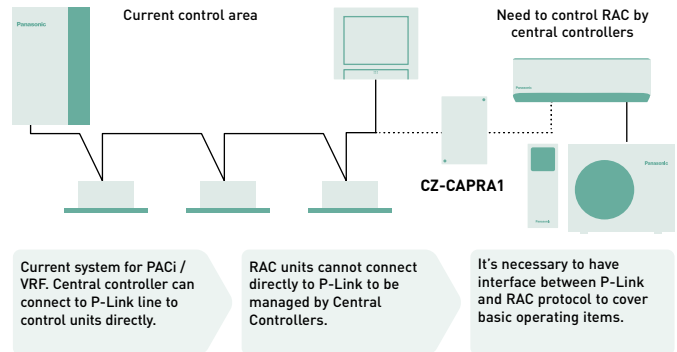

Basic operation items: ON / OFF, Mode select, Temperature setting, Fan speed, Flap setting, Remote control prohibit.

External input: ON / OFF control signal, Abnormal stop signal.

External output for Relay ¹⁾: Operation status (ON / OFF), Alarm status output.

1) Because current CN-CNT connector can not provide the power for external output relay, additional Input power for external relay is necessary.

Connectivity. Control by BMS

Great flexibility for integration into your KNX, Modbus and BACnet projects allows fully bi-directional monitoring and control of all the functioning parameters.

Reference	KNX PAW-AC-KNX-1i	Modbus® PAW-AC-MBS-1	BACnet™ PAW-AC-BAC-1 ¹⁾
Quick installation and possibility of hidden installation	✓	✓	✓
External power not required	✓	✓	✓
Direct connection to the AC indoor unit	✓ (Split or multi split)	✓ (Split or multi split)	✓ (Split or multi split)
Control and monitoring of the internal variables of the indoor unit and error codes and indication	✓ Fully compatible	✓ Fully compatible	✓ Fully compatible
Use the AC ambient temperature or the one measured by external sensor	✓	✓	Only internal temperature
AC unit can be controlled simultaneously by the remote controller of the AC unit and interface devices	✓	✓	✓
Advanced control functions	✓	✓	✓
4 binary inputs. They work as standard interface binary inputs as well as being used to control the AC directly	✓	✗	✗
Total control and supervision. Real states of the AC unit's internal variables	✓	✓	✓

1) This interface allows a complete and natural integration of Panasonic air conditioners into either BACnet IP or MS/TP networks. Is a BTL certified device.

PAW-AC-DIO

Dry contact ON / OFF Interface. Panasonic has developed for hotels applications a dry contact PCB which works with Etherea, RE, UE and YE indoor units in order to control simply the unit centrally.









- ON / OFF signal by 3rd party BMS
- PCB connected to CN-RMT port on indoor unit PCB

Model name	Interface
CZ-TACG1	Wi-Fi adapter for smart control via Panasonic Comfort Cloud App
CZ-CAPRA1	RAC interface adapter for integration into P-Link, plus external input and alarm/status output
PAW-AC-KNX-1i	This interface can be used with all models which have a CN-CNT connector
PAW-AC-MBS-1	This interface can be used with all models which have a CN-CNT connector





Model name	Interface
PAW-AC-BAC-1	This interface can be used with all models which have a CN-CNT connector
PAW-AC-HEAT-1	Heating only PCB for Etherea and low static pressure hide-away
PAW-AC-DIO	This interface can be used with all models which have a CN-RMT connector
PAW-SMSCONTROL	Control of the Etherea by SMS (need additional SIM card)

Accessories and control

Connectivity





 <p>Wi-Fi adapter for smart control via Panasonic Comfort Cloud App.</p> <p>----- CZ-TACG1 ----- 114 €</p>	 <p>RAC interface adapter for integration into P-Link, plus external input and alarm/status output.</p> <p>----- CZ-CAPRA1 ----- 163 €</p>	 <p>This interface can be used with all models which have a CN-CNT connector.</p> <p>----- PAW-AC-KNX-1i ----- 358 €</p>	 <p>This interface can be used with all models which have a CN-CNT connector.</p> <p>----- PAW-AC-MBS-1 ----- 358 €</p>
 <p>This interface can be used with all models which have a CN-CNT connector.</p> <p>----- PAW-AC-BAC-1 ----- 536 €</p>	 <p>This interface can be used with all models which have a CN-RMT connector.</p> <p>----- PAW-AC-DIO ----- 180 €</p>	 <p>Heating only PCB for Etherea and low static pressure hide-away.</p> <p>----- PAW-AC-HEAT-1 ----- 163 €</p>	 <p>Control of the Etherea by SMS (need additional SIM card).</p> <p>----- PAW-SMSCONTROL ----- 280 €</p>

Individual controls

 <p>NEW wired remote controller for wall-mounted and floor console.</p> <p>* Available in Autumn 22.</p> <p>----- CZ-RD517C ----- 144 €</p>	 <p>Infrared remote controller Sky Remote. 2 m cable length of infrared receiver for hide-away.</p> <p>----- CZ-RL511D ----- 105 €</p>	 <p>CONEX wired remote controller (non-wireless) for 4 way 60x60 cassette PY3.</p> <p>----- CZ-RTC6 ----- 144 €</p>	 <p>Wired remote controller for wall-mounted and floor console.</p> <p>----- CZ-RD514C ----- 122 €</p>
---	--	--	--

Panel

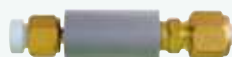
Pipe reducer

 <p>Panel for 4 way 60x60 cassette - PY3.</p> <p>----- CZ-KPY4 ----- 233 €</p>	 <p>Reduces the connection size on the indoor unit from 1/2" to 3/8".</p> <p>----- CZ-MA1PA ----- 19 €</p>	 <p>Increases the connection size on the outdoor unit from 3/8" to 1/2".</p> <p>----- CZ-MA2PA ----- 25 €</p>	 <p>Reduces the connection size on the indoor unit from 5/8" to 1/2".</p> <p>----- CZ-MA3PA ----- 30 €</p>
--	--	--	--

PACi

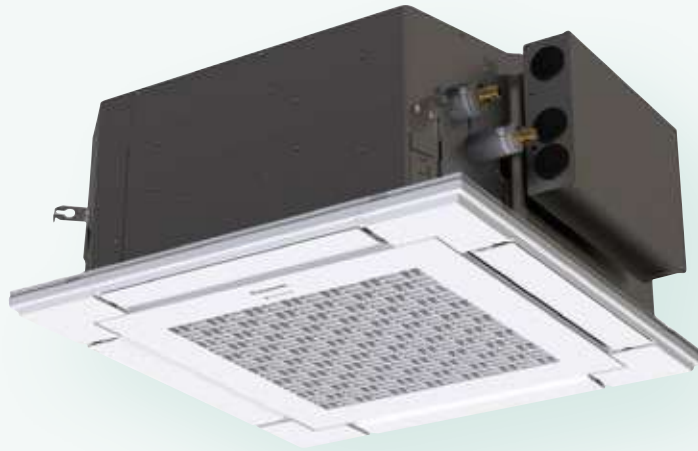

Panasonic Commercial air to air

Panasonic has developed an impressive range of highly efficient Commercial Air Conditioners. This range confirms our commitment to the environment, with our highly efficient inverter compressor technology to optimise performance.

Product quality and safety → 38

Bringing nature's balance indoors → 40

Adaptive ducted unit - PF3 → 41

Low temperature applications → 42

Commercial units range → 44

Wall-mounted Professional Inverter -25 °C → 46

Standard - Elite wall-mounted · R32 → 48

Standard - Elite 4 way 60x60 cassette · R32 → 52

Standard - Elite 4 way 90x90 cassette · R32 → 54

Standard - Elite ceiling · R32 → 58

Standard - Elite adaptive ducted unit · R32 → 62

High static pressure hide-away 20.0-25.0 kW · R32 → 66

Elite 4 way 60x60 cassette · R32 → 68

Commercial PACi NX Multi → 70

Commercial twin, triple and double-twin system · R32 → 72

Hydronic PACi

PRO-HT Tank DHW → 74

PRO-HT Tank heating and cooling → 75

PACi with Water Heat Exchanger · R32 → 76

Accessories and control → 78

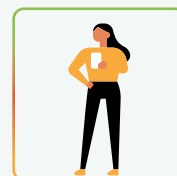
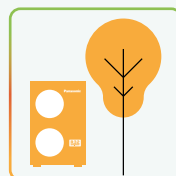
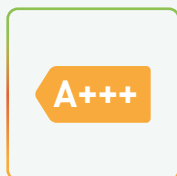

Product quality and safety

All Panasonic air conditioners undergo strict quality and safety tests before sale. This rigorous process includes obtaining all necessary safety approvals, to ensure that all air conditioners we sell are not only built to the highest market standards, but are also completely safe.



Professional air conditioners with R32 refrigerant

Panasonic recommends R32, with lower Global Warming Potential (GWP). Compared to R22 and R410A, R32 has a low potential impact on global warming.

Panasonic takes action in helping to protect the environment. In line with the European countries participating in the Montreal Protocol, protecting the ozone layer and preventing global warming, Panasonic is leading the switch to R32.

1 Installation innovation

- Extremely easy to install, practically the same as R410A
- Single substance refrigerant, which makes it easier to recycle and reuse

2 Environmental innovation

- Zero impact on the ozone layer
- 75 % less impact on global warming

3 Economic and energy consumption innovation

- Lower cost and greater savings
- Higher energy efficiency than R410A

PACi NX Series for absolute ease of refurbishment

These series have been developed with 3 wired power and communication. It makes it simple and easy to replace old systems with 3 wire connections, which is prevalent in many systems.

PACi PZ2/PZH2: 2 wire method.

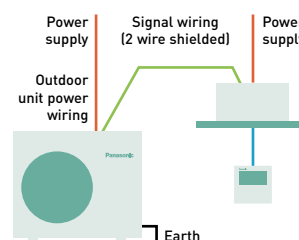

PACi NX Series: 3 wire method.

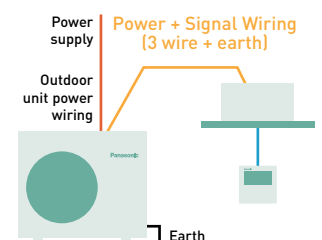

PACi NX Elite: Top-tier commercial air conditioning

Outstanding performance at extreme ambient temperatures with very high energy efficiency both in heating and cooling. Fans, fan motors, compressors and heat exchangers engineered for maximum savings result in higher seasonal efficiencies, which ranks as one of the best in the industry, ensuring reduced CO₂ emissions, energy consumption and operating costs.

From 3.6 to 14.0 kW.

- Meeting all necessary approvals to ensure quality and safety
- Top class SEER: A+++ / SCOP: A+++ at 3.6 kW (in 90x90 cassette)

- Cooling operation is possible with outdoor temperature as high as 48 °C (for 7.1 kW and higher capacities)
- Precise control with DC inverter technology for even more energy saving
- Cooling operation at -20 °C (10.0 kW to 14.0 kW with 30 m maximum pipe length)
- Heating operation at ambient temperature as low as -20 °C
- Compact outdoor units
- Auto restart after power outage
- Twin, triple and double-twin connections

PACi NX Standard: For economy and value

With high quality design and engineering, the PACi NX Standard are the perfect solutions for projects which demand quality on a limited budget. In addition, compact and lightweight design makes them ideal for installations with limited space including small commercial and residential applications. The slim and lightweight outdoor unit design enables installation even in very challenging locations.

From 2.5 to 14.0 kW.

- Extended range of outdoor units starting from 2.5 kW
- Great balance of system cost and performance
- Top class SEER / SCOP in the standard inverter category SEER: A++ / SCOP: A++ up to 7.1 kW (in 90x90 cassette)
- Variety of individual and central controllers which provides full flexibility
- Compact outdoor units, small footprint and lightweight
- Twin connection possible
- Cooling operation down to -10 °C and heating operation down to -15 °C

Big PACi Elite R32

20.0 – 25.0 kW is ideally suited for small and mid retail applications.

In addition to its lightweight, split-able, compact body, the newly designed hide-away unit enables easy installation and pipe work within a narrow void.

Panasonic Big PACi : Environmental friendly, strong and flexible.

- High efficiency with Panasonic compressor as the driving force

- Compact and light indoor body
- Easy pipe work with split-able hide-away indoor design
- Separable indoor unit allows for flexible installation to fit in narrow void
- Water heat exchanger and AHU connection compatibility
- Bluefin anti-corrosion coating of the heat exchanger as standard
- Wide range of controls including Cloud Control compatibility



Bringing nature's balance indoors



nanoe™ X, technology with the benefits of hydroxyl radicals.

Abundant in nature, hydroxyl radicals (also known as OH radicals) have the capacity to inhibit pollutants, viruses, and bacteria to clean and deodorise. nanoe™ X technology can bring these incredible benefits indoors so that hard surfaces, soft furnishings, and the indoor environment can be a cleaner and more pleasant place to be, whether at home, work, or visiting hotels, shops and restaurants etc.



A naturally occurring process

Hydroxyl radicals are unstable molecules looking to react with other elements like hydrogen, capturing it. Thanks to this reaction, hydroxyl radicals have the potential to inhibit the growth of pollutants such as bacteria, viruses, moulds, and odours, breaking them down and neutralising the unpleasant effects. This naturally occurring process has major benefits to improve indoor environments.

Panasonic's nanoe™ X technology takes this a step further and brings nature's detergent – hydroxyl radicals – indoors to help create an ideal environment

Thanks to the nanoe™ X properties, several types of pollutants can be inhibited such as certain types of bacteria, viruses, mould, allergens, pollen and certain hazardous substances.

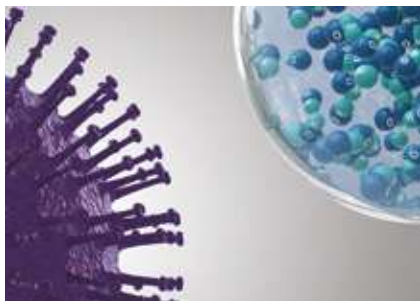

1 | nanoe™ X reliably reaches pollutants.

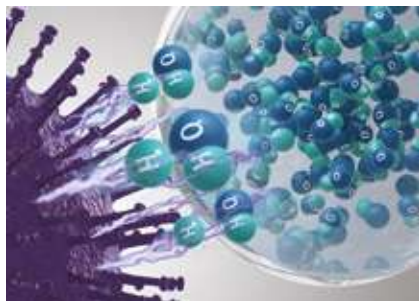

2 | Hydroxyl radicals denature pollutants' proteins.



3 | Pollutants activity is inhibited.

Panasonic Heating & Cooling Solutions is incorporating nanoe™ technology in a wide range of equipment

Built-in nanoe X Generator Mark 1.



4 way 90x90 cassette.
S-****PU3E.
7 capacities: 3.6 - 14.0 kW.

Built-in nanoe X Generator Mark 2.



4 way 60x60 cassette.
S-***PY3E.
4 capacities: 2.5 - 6.0 kW.



Adaptive ducted unit.
S-****PF3E.
7 capacities: 3.6 - 14.0 kW.

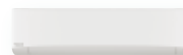

Wall-mounted.
S-****PK3E.
5 capacities: 3.6 - 10.0 kW.



Ceiling.
S-****PT3E.
7 capacities 3.6 - 14.0 kW.

Adaptive ducted unit - PF3

Adaptive ducted - PF3 has been completely re-designed to provide better flexibility. The vertical installation is newly available with powerful external static pressure (maximum 150 Pa).



<https://www.youtube.com/watch?v=LBiRrs0aqXo>

1 Highly flexible installation
2 installation possibilities (horizontal / vertical).

2 High seasonal performance with slim body
Maximum SEER / SCOP: A++ / A++.

3 Comfort operation
Super quiet operation, minimum 22 dB(A)*.

* 3.6 kW model and when operating with external static pressure 50 Pa in low fan mode.

2 installation possibilities (horizontal / vertical)

Vertical installation is newly available. External static pressure 150 Pa, sufficient for remotely installing units away from the rooms.



Improved drain pan design

Just one drain pan for both horizontal and vertical installations. No need to modify the unit.

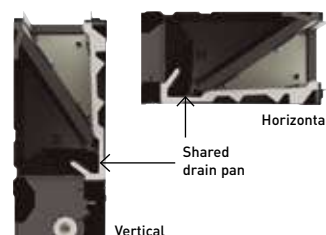

Selectable inlet air position

Inlet air position may be adjusted by means of a removable panel, to allow rear or bottom entry, depending on the duct installation.

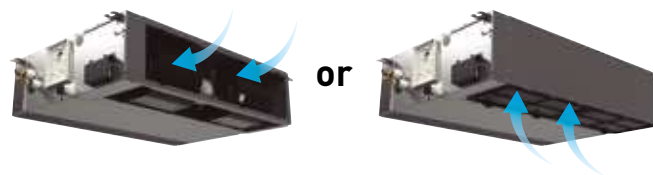

Maximum efficiency

	kW	3.6	5.0	6.0	7.1	10.0		12.5	14.0
Elite	SEER	A++	A++	A++	A++	A++	$\eta_{s,c}$	281.7%	275.9%
	SCOP	A+	A+	A++	A++	A+	$\eta_{s,h}$	170.0%	171.0%
Standard	SEER	—	—	A++	A++	A++	$\eta_{s,c}$	257.4%	252.2%
	SCOP	—	—	A++	A+	A	$\eta_{s,h}$	142.6%	140.6%

Compact body

- Only 250 mm high
- Light units from 25 to 39 kg

Conventional model	Adaptive ducted
33 kg	30 kg
290 mm	250 mm

Adaptive ducted

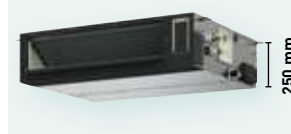

Better indoor air quality with nanoe™ X



The performance of nanoe™ X technology is maintained, even with 10 m long ducts*. The effect of improved air quality is sufficient to allow for numerous duct shapes to fit the application.

* Panasonic internal survey.

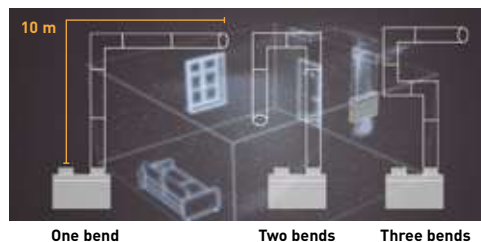

As the experiments demonstrate, up to a duct length of 10 m, effectiveness of nanoe™ X is maintained even if the duct is bended 3 times.

nanoe™ X effect against odour proven in large space

In a room of 139 m², tobacco odour is reduced by a factor of 0.7 when compared to natural reduction over a period of 2 hours.

Tobacco deodorisation ratio.

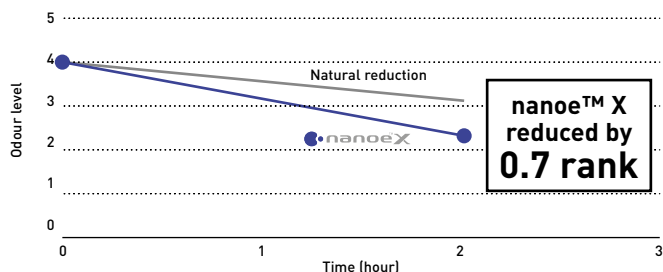

Test ambient.

3rd party international testing institute KAKEN¹⁾ conducted the performance experiment of Adaptive ducted equipped with nanoe X Generator Mark 2 device removing tobacco odour.

1) KAKEN TEST CENTER General Incorporated Foundation in Japan, international testing institute.

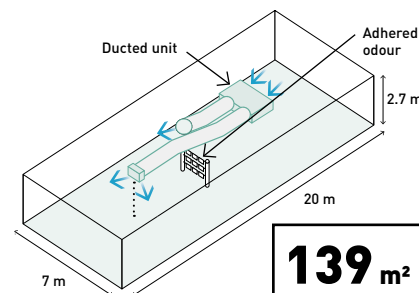

Low temperature applications

Panasonic PACi NX Elite offers a high quality and efficient solution for low temperature applications.



Overview

The Panasonic PACi NX Elite range of semi-industrial systems has been developed to lead the way in quality air conditioning for commercial environments. The Elite line is prevalent in low temperature applications, including wine cellars, server rooms and food storage areas, thanks to its ErP-approved units, and exceptional cooling capabilities.

The range boasts a wide range of features that make it the perfect solution to the needs of challenging commercial and seasonal demands. The units provide continuous cooling when outside temperatures are between $-15\text{ }^{\circ}\text{C}$ and $46\text{ }^{\circ}\text{C}$.

Solutions for cold rooms, wine cellars and special low temperature rooms

Boasting exceptional energy performance, the system ranks among the best in its class (SEER A++) and its inverter technology reduces power consumption and operating costs by 20 %. This, combined with the use of R32 gas to reduce the unit CO_2 emissions, ensures Panasonic PACi solutions offer market-leading efficiency. The latest models in the series are not only built to the highest industry standards to ensure optimum efficiency, they are also lightweight, with a slim and compact design, making these units easy to install.

There is a complete range from 3.6 to 22.0 kW. Just like all the indoor units in the PACi range, these units can be monitored via the internet, generating an alarm if there is a breakdown.

One of the main features of the PACi series is the possibility of adjusting the product for special applications, not just for regular heating and cooling applications. The PACi NX Elite range caters special applications that require cooling to maintain rooms between $8\text{ }^{\circ}\text{C WB}$ and $24\text{ }^{\circ}\text{C WB}$ ($10\text{ }^{\circ}\text{C DB}$ - $30\text{ }^{\circ}\text{C DB}$).

The perfect solution for:

- Wine cellars
- Ice cream factories
- Flower shops
- Supermarkets
- Grain stores
- Food storage
- Food processing
- Food distribution
- Lunchrooms
- Vegetable processing

Range of temperature for wine cellar

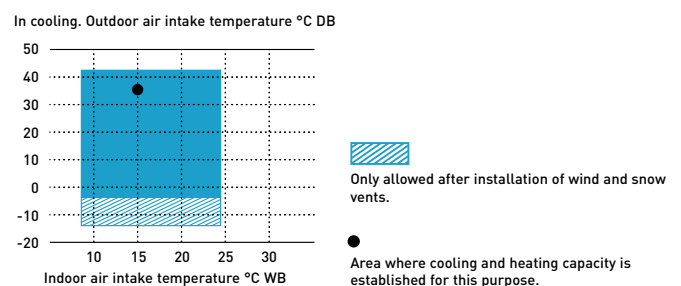

Low temperature compatible unit configurations

The PACi NX Elite range caters special applications that require cooling to maintain rooms between 8°CWB and 24°CWB (10°CDB 30°CDB). In order adjust the product for low temperature applications, in terms of enthalpy, the indoor unit needs to be over-dimensioned and certain parameters need to be adjustable. Below are the compatible configurations for each of the PACi NX Elite range.



Wall-mounted (PK3)									
	Low temp. 36	Low temp. 50	Low temp. 60	Low temp. 71	Low temp. 100	Low temp. 125	Low temp. 140	Low temp. 200	Low temp. 250
Kit	KIT-NXLT36PK3	KIT-NXLT50PK3	KIT-NXLT60PK3	KIT-NXLT71PK3 / -3PH	KIT-NXLT100PK3 / -3PH	KIT-NXLT125PK3 / -3PH	KIT-NXLT140PK3 / -3PH	N/A	N/A
Indoor unit	S-6010PK3E	S-6010PK3E	S-6010PK3E	S-6010PK3Ex2	S-6010PK3Ex2	S-6010PK3Ex2	S-6010PK3Ex2	N/A	N/A
Outdoor unit	U-36PZH3E5	U-50PZH3E5	U-60PZH3E5	U-71PZH3E5/8	U-100PZH3E5/8	U-125PZH3E5/8	U-140PZH3E5/8	N/A	N/A
Kit single phase RRP £	2.093	2.285	2.428	3.803	4.285	4.559	4.999	-	-
Kit three phase RRP £	-	-	-	3.856	4.322	4.675	5.318	-	-

Ceiling (PT3)									
	Low temp. 36	Low temp. 50	Low temp. 60	Low temp. 71	Low temp. 100	Low temp. 125	Low temp. 140	Low temp. 200	Low temp. 250
Kit	KIT-NXLT36PT3	KIT-NXLT50PT3	KIT-NXLT60PT3	KIT-NXLT71PT3 / -3PH	KIT-NXLT100PT3 / -3PH	KIT-NXLT125PT3 / -3PH	KIT-NXLT140PT3 / -3PH	KIT-NXLT200PT3-3PH	KIT-NXLT250PT3-3PH
Indoor unit	S-6071PT3E	S-6071PT3E	S-1014PT3E	S-1014PT3E	S-1014PT3E	S-1014PT3E	S-1014PT3Ex2	S-1014PT3Ex2	S-1014PT3Ex2
Outdoor unit	U-36PZH3E5	U-50PZH3E5	U-60PZH3E5	U-71PZH3E5/8	U-100PZH3E5/8	U-125PZH3E5/8	U-140PZH3E5/8	U-200PZH2E8	U-250PZH2E8
Kit single phase RRP £	2.170	2.362	2.505	2.899	3.381	3.655	5.153	-	-
Kit three phase RRP £	-	-	-	2.952	3.418	3.771	5.472	5.517	5.977

4 way 90x90 cassette (PU3)									
	Low temp. 36	Low temp. 50	Low temp. 60	Low temp. 71	Low temp. 100	Low temp. 125	Low temp. 140	Low temp. 200	Low temp. 250
Kit	KIT-NXLT36PU3	KIT-NXLT50PU3	KIT-NXLT60PU3	KIT-NXLT71PU3 / -3PH	KIT-NXLT100PU3 / -3PH	KIT-NXLT125PU3 / -3PH	KIT-NXLT140PU3 / -3PH	KIT-NXLT200PU3-3PH	KIT-NXLT250PU3-3PH
Indoor unit	S-6071PU3E	S-6071PU3E	S-6071PU3E	S-1014PU3E	S-1014PU3E	S-1014PU3E	S-1014PU3Ex2	S-1014PU3Ex2	S-1014PU3Ex2
Outdoor unit	U-36PZH3E5	U-50PZH3E5	U-60PZH3E5	U-71PZH3E5/8	U-100PZH3E5/8	U-125PZH3E5/8	U-140PZH3E5/8	U-200PZH2E8	U-250PZH2E8
Kit single phase RRP £	1.973	2.165	2.308	2.887	3.369	3.643	5.129	-	-
Kit three phase RRP £	-	-	-	2.940	3.406	3.759	5.448	5.493	5.953











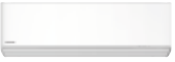
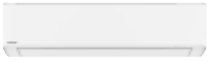

Adaptive ducted unit (PF3)									
	Low temp. 36	Low temp. 50	Low temp. 60	Low temp. 71	Low temp. 100	Low temp. 125	Low temp. 140	Low temp. 200	Low temp. 250
Kit	KIT-NXLT36PF3	KIT-NXLT50PF3	KIT-NXLT60PF3	KIT-NXLT71PF3 / -3PH	KIT-NXLT100PF3 / -3PH	KIT-NXLT125PF3 / -3PH	KIT-NXLT140PF3 / -3PH	N/A	N/A
Indoor unit	S-6071PF3E	S-6071PF3E	S-6071PF3E	S-1014PF3E	S-1014PF3E	S-1014PF3E	S-1014PF3Ex2	N/A	N/A
Outdoor unit	U-36PZH3E5	U-50PZH3E5	U-60PZH3E5	U-71PZH3E5/8	U-100PZH3E5/8	U-125PZH3E5/8	U-140PZH3E5/8	N/A	N/A
Kit single phase RRP £	2.174	2.366	2.509	3.203	3.685	3.959	5.761	-	-
Kit three phase RRP £	-	-	-	3.256	3.722	4.075	6.080	-	-

Accessories	RRP £
PAW-WTRAY Tray for condenser water compatible with outdoor elevation platform	133
PAW-GRDBSE20 Outdoor base ground support for noise and vibration absorption	122
PAW-GRDSTD40 Outdoor elevation platform 400x900x400 mm	133

Accessories	RRP £
CZ-CENSC1 Econavi energy savings sensor	151
CZ-56DAF2 Air outlet plenum for S-3650PF3E	172
CZ-90DAF2 Air outlet plenum for S-6071PF3E	211
CZ-160DAF2 Air outlet plenum for S-1014PF3E	242

All pricing includes the CZ-RTC5B remote controller. All PU3 model pricing includes the CZ-KPU3W panel. Branch pipes are included in the pricing on systems with multiple indoors.

Commercial units range

Page	Indoor units	2.5 kW	3.6 kW	4.5 kW ¹⁾	5.0 kW	6.0 kW
P. 46	NEW wall-mounted Professional Inverter · R32 ²⁾	 CS-Z25YKEA	 CS-Z35YKEA	 CS-Z42YKEA	 CS-Z50YKEA	
P. 48	Wall-mounted Inverter+ · R32		 S-3650PK3E	 S-3650PK3E	 S-3650PK3E	 S-6010PK3E
P. 52	4 way 60x60 cassette Inverter+ · R32	 S-25PY3E	 S-36PY3E		 S-50PY3E	 S-60PY3E
P. 54	4 way 90x90 cassette Inverter+ · R32		 S-3650PU3E	 S-3650PU3E	 S-3650PU3E	 S-6071PU3E
P. 58	Ceiling Inverter+ · R32		 S-3650PT3E	 S-3650PT3E	 S-3650PT3E	 S-6071PT3E
P. 62	Adaptive ducted Inverter+ · R32		 S-3650PF3E	 S-3650PF3E	 S-3650PF3E	 S-6071PF3E
P. 66	High static pressure hide-away 20-25 kW Inverter+ · R32					
P. 68	4 Way 60x60 cassette Inverter+ · R32		 S-36PY2E5B	 S-45PY2E5B	 S-50PY2E5B	

Outdoor units	2,5 kW	3,6 kW	5,0 kW	6,0 kW
PACi NX Elite · R32		 U-36PZH3E5 / U-36PZH2E5 ³⁾	 U-50PZH3E5 / U-50PZH2E5 ³⁾	 U-60PZH3E5
PACi NX Standard · R32	 U-25PZ3E5	 U-36PZ3E5	 U-50PZ3E5	 U-60PZ3E5A

1) The 4,5 kW indoor capacity options are only available only for twin, triple and double-twin combinations. 2) Not compatible with PACi NX outdoors and accessories. Domestic range sales conditions may apply. Check with your sales representative. 3) PZH2 models only for PY2 models. 4) These two units are not in PACi NX range but part of Big PACi range. * U-__E5 Single phase / U-__E8 Three phase.

OPTIONAL UNITS ON VENTILATION SECTION

7.1 kW

10.0 kW

12.5 kW

14.0 kW

20.0 kW

25.0 kW

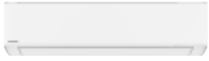

CS-Z71YKEA



S-6010PK3E



S-6010PK3E



S-6071PU3E



S-1014PU3E



S-1014PU3E



S-1014PU3E



S-6071PT3E



S-1014PT3E



S-1014PT3E



S-1014PT3E



S-6071PF3E



S-1014PF3E



S-1014PF3E



S-1014PF3E



S-200PE3E5B



S-250PE3E5B

7,1 kW

10,0 kW

12,5 kW

14,0 kW

20,0 kW

25,0 kW



U-71PZH3E5 / U-71PZH3E8



U-100PZH3E5 / U-100PZH3E8



U-125PZH3E5 / U-125PZH3E8



U-140PZH3E5 / U-140PZH3E8



U-200PZH2E8 ⁴⁾



U-250PZH2E8 ⁴⁾



U-71PZ3E5A



U-100PZ3E5 / U-100PZ3E8



U-125PZ3E5 / U-125PZ3E8



U-140PZ3E5 / U-140PZ3E8

Solutions for server rooms

High efficiency products for 24/7 applications. Panasonic has developed a complete range of solutions for server rooms which efficiently protect your servers, keeping them at an appropriate temperature even when the outdoor temperature is below -25°C .



Not compatible with PACi NX outdoors and accessories. Domestic range sales conditions may apply. Check with your sales representative.



1 Designed for 24h/7d a week operation

High efficiency all year round. This wall-mounted air conditioner is designed for professional, critical applications such as computer rooms where reliable cooling inside the room is necessary even with extreme ambient conditions.

2 New remote controller for better usability

New wired remote controller, which can assure the operation 24/7 of two server room units, thanks to the integrated Duty Rotation mode. This function manages Rotation and back-up of two units and it is available when connecting an optional CN-CNT Cable (CZ-RCC5) between the controller and each of the two indoor units.

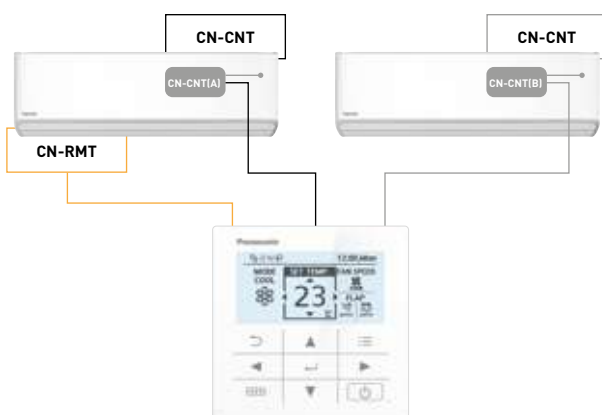

3 Highest energy rating in cooling

The SEER and SCOP of the Server room unit has been further improved to achieve top class energy efficiency. The 3,5 kW unit reaches now the SEER value of 9,6 (A+++).

4 Built-in Wi-Fi and compatible with Voice Assistant

The unit is ready to connect to the internet and to be controlled by smartphone with Panasonic Comfort Cloud App. Control, monitor energy consumption statistics and easily identify errors in case of failure

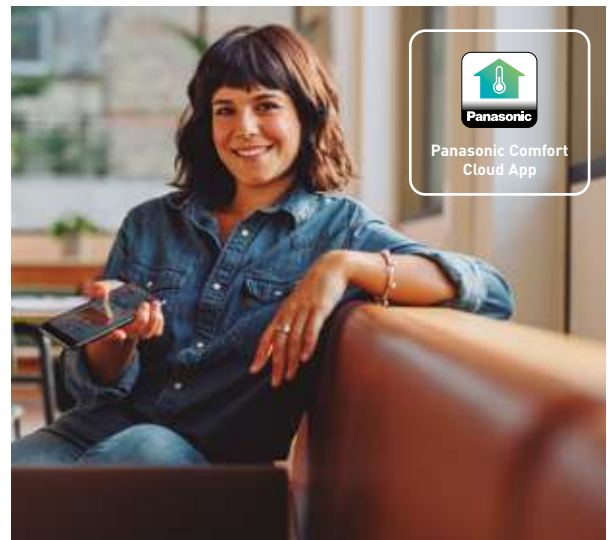

NEW
2022

NEW wall-mounted Professional Inverter -25 °C · R32

- Designed for 24h/7d a week operation
- New wired remote controller, with optional Duty Rotation mode
- Improved SEER / SCOP to achieve top class energy efficiency
- Aerowings 2.0, for a better control of the airflow
- Built-in Wi-Fi for instant connectivity via Panasonic Comfort Cloud App
- Compatible with Google Assistant and Amazon Alexa
- Chassis and parts designed for easier installation

Kit			KIT-Z25-YKEA	KIT-Z35-YKEA	KIT-Z42-YKEA	KIT-Z50-YKEA	KIT-Z71-YKEA
Cooling capacity	Nominal (Min - Max)	kW	2.50 (0.85 - 3.50)	3.50 (0.85 - 4.20)	4.20 (0.85 - 5.00)	5.00 (0.98 - 6.00)	7.10 (0.98 - 8.50)
UK cooling	Total - Sensible	kW	2.49 - 1.90	3.48 - 2.66	4.18 - 3.19	4.66 - 4.25	6.55 - 5.20
EER ¹⁾	Nominal (Min - Max)	W/W	4.90 (4.72 - 3.98)	4.12 (4.72 - 3.68)	3.82 (4.72 - 3.25)	3.68 (3.92 - 3.16)	3.23 (2.33 - 2.83)
SEER ²⁾			9.5 A+++	9.6 A+++	8.6 A+++	8.6 A+++	6.5 A++
Pdesign		kW	2.50	3.50	4.20	5.00	7.10
Input power	Nominal (Min - Max)	kW	0.51 (0.18 - 0.88)	0.85 (0.18 - 1.14)	1.10 (0.18 - 1.54)	1.36 (0.25 - 1.90)	2.20 (0.42 - 3.00)
Annual energy consumption ³⁾		kWh/a	92	128	171	203	382
Heating capacity	Nominal (Min - Max)	kW	3.40 (0.85 - 5.00)	4.00 (0.85 - 5.80)	5.30 (0.85 - 6.80)	5.80 (0.98 - 8.00)	8.20 (0.98 - 10.20)
UK heating	Total	kW	3.78	4.62	5.05	5.62	6.94
Heating capacity at -7 °C		kW	3.05	3.40	4.11	4.80	6.31
COP ¹⁾	Nominal (Min - Max)	W/W	4.86 (4.72 - 3.97)	4.44 (4.72 - 3.87)	3.93 (4.72 - 3.66)	4.08 (4.26 - 3.35)	3.71 (2.45 - 3.29)
SCOP ²⁾			4.6 A++	4.6 A++	4.5 A+	4.6 A++	4.1 A+
Pdesign at -10 °C		kW	2.70	3.20	3.60	4.20	5.50
Input power	Nominal (Min - Max)	kW	0.70 (0.18 - 1.26)	0.90 (0.18 - 1.50)	1.35 (0.18 - 1.86)	1.42 (0.23 - 2.39)	2.21 (0.40 - 3.10)
Annual energy consumption ³⁾		kWh/a	822	974	1120	1278	1878
Indoor unit			CS-Z25YKEA	CS-Z35YKEA	CS-Z42YKEA	CS-Z50YKEA	CS-Z71YKEA
Power supply		V	230	230	230	230	230
Fuse size	Recommended / Max	A	10/16	13/16	13/16	16/16	20/20
Connection indoor / outdoor		mm ²	4x1.5	4x1.5	4x1.5	4x2.5	4x2.5
Air flow	Cool / Heat	m ³ /sec	0.19/0.23	0.21/0.25	0.22/0.25	0.29/0.32	0.32/0.33
Moisture removal volume		L/h	1.5	2.0	2.4	2.8	4.1
Sound pressure ⁴⁾	Cool (Hi / Lo / Q-Lo)	dB(A)	39/25/21	42/28/21	43/32/29	44/37/30	47/38/35
	Heat (Hi / Lo / Q-Lo)	dB(A)	41/27/22	43/30/22	44/35/29	44/37/30	47/38/35
Sound power	Cool / Heat (Hi)	dB(A)	55/57	58/59	59/60	60/60	63/63
Dimension	HxWxD	mm	295x870x229	295x870x229	295x870x229	295x1040x244	295x1040x244
Net weight		kg	11	11	11	12	13
Outdoor unit			CU-Z25YKEA	CU-Z35YKEA	CU-Z42YKEA	CU-Z50YKEA	CU-Z71YKEA
Air flow	Cool / Heat	m ³ /sec	0.46/0.46	0.50/0.50	0.50/0.52	0.66/0.62	0.75/0.76
Sound pressure ⁴⁾	Cool / Heat (Hi)	dB(A)	46/48	48/50	48/51	48/50	52/54
Sound power	Cool / Heat (Hi)	dB(A)	61/63	63/65	63/66	63/65	66/68
Dimension ⁵⁾	HxWxD	mm	542x780x289	542x780x289	542x780x289	695x875x320	695x875x320
Net weight		kg	30	30	30	40	45
Piping diameter	Liquid pipe	Inch (mm)	1/4 (6.35)	1/4 (6.35)	1/4 (6.35)	1/4 (6.35)	1/4 (6.35)
	Gas pipe	Inch (mm)	3/8 (9.52)	3/8 (9.52)	1/2 (12.70)	1/2 (12.70)	5/8 (15.88)
Pipe length range		m	3 - 20	3 - 20	3 - 20	3 - 30	3 - 30
Elevation difference (in / out)		m	15	15	15	15	20
Pipe length for additional gas		m	7.5	7.5	7.5	7.5	10
Additional gas amount		g/m	10	10	10	15	25
Refrigerant (R32) / CO ₂ Eq.		kg / T	0.89/0.60	0.89/0.60	0.97/0.65	1.13/0.76	1.35/0.91
Operating range	Cool Min ~ Max	°C	-25 ~ +43	-25 ~ +43	-25 ~ +43	-25 ~ +43	-25 ~ +43
	Heat Min ~ Max	°C	-15 ~ +24	-15 ~ +24	-15 ~ +24	-15 ~ +24	-15 ~ +24
Kit RRP		£	1.132	1.298	1.555	1.639	2.221
Indoor unit RRP		£	367	404	519	555	766
Outdoor unit RRP		£	765	894	1.036	1.084	1.455

1) EER and COP calculation is based in accordance to EN14511. 2) Energy Label Scale from A+++ to D. 3) The annual energy consumption is calculated in accordance to EU/626/2011. 4) The sound pressure of the indoor unit shows the value measured at a position of 1 m in front of the main body and 0.8 m below the unit. For outdoor unit 1 m in front and 1 m in rear side of main body. The sound pressure is measured in accordance with JIS C 9612. Q-Lo: Quiet mode. Lo: The lowest set fan speed. 5) Add 70 mm for piping port. * Available in February 2022. ** Not compatible with PACI NX outdoors and accessories. Domestic range sales conditions may apply. Check with your sales representative.

Accessories		RRP £
PAW-WTRAY	Tray for condenser water compatible with outdoor elevation platform	133
CZ-RCC5	CN-CNT cables x2 for server room application, control of 2 units, rotation, back-up, etc.	tbc

Accessories		RRP £
PAW-GRDBSE20	Outdoor base ground support for noise and vibration absorption	122
PAW-GRDSTD40	Outdoor elevation platform 400x900x400 mm	133



SEER: For KIT-Z35-YKEA. SCOP: For KIT-Z25-YKEA, KIT-Z35-YKEA and KIT-Z50-YKEA. SUPER QUIET: For KIT-Z25-YKEA. INTERNET CONTROL: Built-in Wi-Fi.

Rating Conditions: Cooling Indoor 27 °C DB / 19 °C WB. Cooling Outdoor 35 °C DB / 24 °C WB. Heating Indoor 20 °C DB. Heating Outdoor 7 °C DB / 6 °C WB. [DB: Dry Bulb; WB: Wet Bulb]. Specifications subject to change without notice. For detailed information about ErP / Energy Labelling, please visit our websites www.panasonic.co.uk/aircon or www.ptc.panasonic.eu.



nanoe™ X as a standard.

PACi NX Series Standard wall-mounted Inverter+ · R32

The wall-mounted units with stylish matt color can be offered for many applications such as studios, gyms, high ceiling areas and even computer server rooms.

The compact design and flat face ensure discreet installation, even in a small space.



		Single phase					
		3.6 kW	5.0 kW	6.0 kW	7.1 kW	10.0 kW	
Kit		KIT-36PK3Z5	KIT-50PK3Z5	KIT-60PK3Z5	KIT-71PK3Z5	KIT-100PK3Z5	
Remote controller		CZ-RTC5B	CZ-RTC5B	CZ-RTC5B	CZ-RTC5B	CZ-RTC5B	
Cooling capacity	Nominal (Min - Max)	kW	3.6(1.5 - 4.0)	5.0(1.5 - 5.6)	6.1(2.0 - 7.1)	7.1(2.6 - 7.7)	9.0(3.0 - 9.7)
UK cooling	Total - Sensible	kW	3.4 - 2.4	4.8 - 3.2	6.0 - 4.0	6.7 - 4.4	9.0 - 5.6
EER ¹⁾	Nominal (Min - Max)	W/W	4.14(3.74 - 5.88)	3.52(3.03 - 6.25)	3.67(3.01 - 6.90)	3.16(2.77 - 5.00)	3.47(3.13 - 5.36)
SEER ²⁾			7.6 A++	7.4 A++	7.0 A++	5.8 A+	6.5 A++
Pdesign		kW	3.6	5.0	6.1	7.1	9.0
Input power	Nominal (Min - Max)	kW	0.87(0.26 - 1.07)	1.42(0.24 - 1.85)	1.66(0.29 - 2.36)	2.25(0.52 - 2.78)	2.59(0.56 - 3.10)
Annual energy consumption ³⁾		kWh/a	166	237	3.05	429	485
Heating capacity	Nominal (Min - Max)	kW	3.6(1.5 - 4.6)	5.0(1.5 - 6.4)	6.1(1.8 - 7.0)	7.1(2.1 - 8.1)	9.0(3.0 - 10.5)
UK heating	Total	kW	3.9	5.6	6.1	6.9	9.6
COP ¹⁾	Nominal (Min - Max)	W/W	4.62(4.11 - 6.52)	4.20(3.17 - 7.50)	4.39(3.18 - 7.50)	4.23(3.38 - 6.36)	3.93(3.56 - 5.36)
SCOP ²⁾			4.5 A+	4.4 A+	4.7 A++	4.4 A+	3.9 A
Pdesign at -10 °C		kW	2.8	4.0	4.6	5.2	9.0
Input power	Nominal (Min - Max)	kW	0.78(0.23 - 1.12)	1.19(0.20 - 2.02)	1.39(0.24 - 2.20)	1.68(0.33 - 2.40)	2.29(0.56 - 2.95)
Annual energy consumption ³⁾		kWh/a	872	1273	1370	1653	3231
Indoor unit			S-3650PK3E	S-3650PK3E	S-6010PK3E	S-6010PK3E	S-6010PK3E
Air flow	Hi / Med / Lo	m ³ /sec	0.22/0.18/0.15	0.27/0.23/0.18	0.33/0.29/0.24	0.33/0.29/0.24	0.37/0.31/0.25
Moisture removal volume		L/h	0.9	1.8	2.0	3.0	4.3
Sound pressure ⁴⁾	Hi / Med / Lo	dB(A)	35/31/27	40/36/32	47/44/40	47/44/40	49/45/41
Sound power	Hi / Med / Lo	dB(A)	51/47/43	56/52/48	63/60/56	63/60/56	65/61/57
Dimension	H x W x D	mm	302 x 1120 x 236	302 x 1120 x 236	302 x 1120 x 236	302 x 1120 x 236	302 x 1120 x 236
Net weight		kg	13	13	14	14	14
nanoe X Generator			Mark 2	Mark 2	Mark 2	Mark 2	Mark 2
Outdoor unit			U-36PZ3E5	U-50PZ3E5	U-60PZ3E5A	U-71PZ3E5A	U-100PZ3E5
Power supply		V	220 - 230 - 240	220 - 230 - 240	220 - 230 - 240	220 - 230 - 240	220 - 230 - 240
Maximum fuse size		A	15	15	20	20	35
Current	Cool	A	4.05 - 3.85 - 3.70	6.60 - 6.30 - 6.05	7.70 - 7.35 - 7.05	10.4 - 10.00 - 9.55	12.9 - 12.4 - 11.9
	Heat	A	3.65 - 3.50 - 3.35	5.60 - 5.35 - 5.10	6.45 - 6.15 - 5.90	7.80 - 7.45 - 7.15	11.4 - 10.9 - 10.5
Air flow	Cool / Heat	m ³ /sec	0.56/0.57	0.55/0.53	0.71/0.69	0.75/0.77	1.22/1.22
Sound pressure	Cool / Heat (Hi)	dB(A)	46/47	46/46	47/48	48/49	52/52
Sound power	Cool / Heat (Hi)	dB(A)	64/66	64/64	64/65	66/68	70/70
Dimension	H x W x D	mm	619 x 824 x 299	619 x 824 x 299	695 x 875 x 320	695 x 875 x 320	996 x 980 x 370
Net weight		kg	32	35	42	50	83
Piping diameter	Liquid pipe	Inch (mm)	1/4(6.35)	1/4(6.35)	1/4(6.35) ⁵⁾	1/4(6.35) ⁵⁾	3/8(9.52)
	Gas pipe	Inch (mm)	1/2(12.70)	1/2(12.70)	1/2(12.70) ⁶⁾	5/8(15.88) ⁶⁾	5/8(15.88)
Pipe length range		m	3 - 15	3 - 20	3 - 40	3 - 40	5 - 50
Elevation difference (in / out) ⁷⁾		m	15/15	15/15	15/30	20/30	15/30
Pipe length for additional gas		m	7.5	7.5	30	30	30
Additional gas amount		g/m	10	15	15	17	45
Refrigerant (R32) / CO ₂ Eq.		kg / T	0.87/0.59	1.14/0.77	1.15/0.78	1.32/0.89	2.4/1.62
Operating range	Cool Min ~ Max	°C	-10 ~ +43	-10 ~ +43	-10 ~ +43	-10 ~ +43	-10 ~ +43
	Heat Min ~ Max	°C	-15 ~ +24	-15 ~ +24	-15 ~ +24	-15 ~ +24	-15 ~ +24
Kit RRP		£	1.666	1.894	2.130	2.427	2.720
Indoor unit RRP		£	754	754	981	981	981
Outdoor unit RRP		£	768	996	1.005	1.302	1.595
Wired control RRP		£	144	144	144	144	144

Technical focus

- Modern design with flat face and compact size
- DC fan for better efficiency and control
- Six directional piping outlet
- nanoe™ X (Generator Mark 2= 9.6 trillion hydroxyl radicals/sec) as standard for better indoor air quality
- Wired remote control CZ-RTC6BL allows easy system setting via Bluetooth®
- Easy connection and control of external fan or ERV using the connector PAW-FDC on the indoor unit PCB. The external device can be controlled by the remote control of the Panasonic indoor unit

Closed discharge port

When the unit is turned OFF, the flap closes completely to prevent dust getting into the unit and to keep the equipment clean.

Quiet operation

These units are among the quietest in the industry, making them ideal for hotels and hospitals.

Piping outlet in six directions

Piping outlet is possible in six directions of right, right rear, right bottom, left, left rear and left bottom, making the installation work more flexible.



CZ-RTC5B

COMPATIBLE WITH ALL PANASONIC CONNECTIVITY SOLUTIONS. FOR DETAILED INFORMATION GO TO THE CONTROL SYSTEMS SECTION



CONEX



Optional controller.
CONEX wired remote controller.
CZ-RTC6 - CZ-RTC6BL
- CZ-RTC6BLW



Optional controller.
Infrared remote controller.
CZ-RWS3



Optional Econavi sensor.
CZ-CENSC1

			Three phase
			10.0 kW
Kit			KIT-100PK3Z8
Remote controller			CZ-RTC5B
Cooling capacity	Nominal (Min - Max)	kW	9.0 (3.0 - 9.7)
UK cooling	Total - Sensible	kW	9.0 - 5.6
EER ¹⁾	Nominal (Min - Max)	W/W	3.47 (5.36 - 3.13)
SEER ²⁾			6.5 A++
P _{design}		kW	9.0
Input power	Nominal (Min - Max)	kW	2.59 (0.56 - 3.10)
Annual energy consumption ³⁾		kWh/a	485
Heating capacity	Nominal (Min - Max)	kW	9.0 (3.0 - 10.5)
UK heating	Total	kW	9.6
COP ¹⁾	Nominal (Min - Max)	W/W	3.93 (5.36 - 3.56)
SCOP ²⁾			3.9 A
P _{design} at -10 °C		kW	9.0
Input power	Nominal (Min - Max)	kW	2.29 (0.56 - 2.95)
Annual energy consumption ³⁾		kWh/a	3231
Indoor unit			S-6010PK3E
Air flow	Hi / Med / Lo	m ³ /sec	0.37/0.31/0.25
Moisture removal volume		L/h	4.3
Sound pressure ⁴⁾	Hi / Med / Lo	dB(A)	49/45/41
Sound power	Hi / Med / Lo	dB(A)	65/61/57
Dimension	H x W x D	mm	302 x 1120 x 236
Net weight		kg	14
nanoe X Generator			Mark 2
Outdoor unit			U-100PZ3E8
Power supply		V	380 - 400 - 415
Maximum fuse size		A	15
Current	Cool	A	4.30 - 4.10 - 3.95
	Heat	A	3.80 - 3.65 - 3.50
Air flow	Cool / Heat	m ³ /sec	1.22/1.22
Sound pressure	Cool / Heat (Hi)	dB(A)	52/52
Sound power	Cool / Heat (Hi)	dB(A)	70/70
Dimension	H x W x D	mm	996 x 980 x 370
Net weight		kg	83
Piping diameter	Liquid pipe	Inch (mm)	3/8 (9.52)
	Gas pipe	Inch (mm)	5/8 (15.88)
Pipe length range		m	5 - 50
Elevation difference (in / out) ⁷⁾		m	15/30
Pipe length for additional gas		m	30
Additional gas amount		g/m	45
Refrigerant (R32) / CO ₂ , Eq.		kg / T	2.4 / 1.62
Operating range	Cool Min ~ Max	°C	-10 ~ +43
	Heat Min ~ Max	°C	-15 ~ +24
Kit RRP		£	2.818
Indoor unit RRP		£	981
Outdoor unit RRP		£	1.693
Wired control RRP		£	144

1) EER and COP calculation is based in accordance to EN14511. 2) For models below 12 kW, the SEER and SCOP is calculated based on values of EU/626/2011. For models above 12 kW, the $\eta_{h,c}$ / $\eta_{h,h}$ values is calculated based on EN 14825. 3) Factory setting. 4) The sound pressure of the units shows the value measured of the position 1 m in front of the main body and 1 m below the unit. The sound pressure is measured in accordance with Eurovent 6/C/006-97 specification. 5) Connect the liquid socket tube (Ø6.35-Ø9.52) to the liquid tubing side indoor unit. 6) Connect the gas socket tube (Ø12.70-Ø15.88) to the gas tubing side indoor unit. 7) Outdoor unit located lower / outdoor unit located higher. * Recommended fuse for the indoor 3 A. ** Above values are in the case of nanoe™ X OFF.

Accessories		RRP £
CZ-RTC6L	CONEX wired remote controller (non-wireless)	144
CZ-RTC6BL	CONEX wired remote controller with Bluetooth®	172
CZ-RTC6BLW	CONEX wired remote controller with Wi-Fi and Bluetooth®	242
CZ-RTC5B	Wired remote controller with Econavi function and datanavi	144
CZ-RWS3	Infrared remote controller	108
CZ-CAPWFC1	Commercial Wi-Fi Adaptor	176

Accessories		RRP £
PAW-PACR3	Interfaces to run 3 units on back-up and alternative run	1.745
PAW-WTRAY	Tray for condenser water compatible with outdoor elevation platform	133
PAW-GRDBSE20	Outdoor base ground support for noise and vibration absorption	122
PAW-GRDSTD40	Outdoor elevation platform 400 x 900 x 400 mm	133
CZ-CENSC1	Econavi energy savings sensor	151



SEER: For S-3650PK3E + U-36PZ3E5. SCOP: For S-6010PK3E + U-60PZ3E5A. INTERNET CONTROL: Optional.

Rating Conditions: Cooling Indoor 27 °C DB / 19 °C WB. Cooling Outdoor 35 °C DB / 24 °C WB. Heating Indoor 20 °C DB. Heating Outdoor 7 °C DB / 6 °C WB. (DB: Dry Bulb; WB: Wet Bulb). Specifications subject to change without notice. For detailed information about ErP / Energy Labelling, please visit our websites www.panasonic.co.uk/aircon or www.ptc.panasonic.eu.



nanoe™ X as a standard.

PACi NX Series Elite wall-mounted Inverter+ · R32

The wall-mounted units with stylish matt color can be offered for many applications such as studios, gyms, high ceiling areas and even computer server rooms.

The compact design and flat face ensure discreet installation, even in a small space.



			Single phase				
			3.6 kW	5.0 kW	6.0 kW	7.1 kW	10.0 kW
Kit			KIT-36PK3ZH5	KIT-50PK3ZH5	KIT-60PK3ZH5	KIT-71PK3ZH5	KIT-100PK3ZH5
Remote controller			CZ-RTC5B	CZ-RTC5B	CZ-RTC5B	CZ-RTC5B	CZ-RTC5B
Cooling capacity	Nominal (Min - Max)	kW	3.6 [1.2 - 4.0]	5.0 [1.2 - 5.6]	6.1 [1.2 - 7.1]	7.1 [2.2 - 9.0]	9.5 [3.1 - 10.5]
UK cooling	Total - Sensible	kW	3.5 - 2.4	4.9 - 3.4	6.0 - 4.0	8.1 - 5.1	9.6 - 5.9
EER ¹⁾	Nominal (Min - Max)	W/W	4.93 [4.49 - 5.45]	4.24 [3.61 - 5.45]	3.86 [3.02 - 5.45]	3.50 [2.69 - 5.79]	3.26 [3.09 - 5.34]
SEER ²⁾			8.4 A++	8.0 A++	7.2 A++	6.8 A++	6.4 A++
Pdesign		kW	3.6	5.0	6.1	7.1	9.5
Input power	Nominal (Min - Max)	kW	0.73 [0.22 - 0.89]	1.18 [0.22 - 1.55]	1.58 [0.22 - 2.35]	2.03 [0.38 - 3.35]	2.91 [0.58 - 3.40]
Annual energy consumption ³⁾		kWh/a	150	219	297	365	520
Heating capacity	Nominal (Min - Max)	kW	4.0 [1.2 - 5.0]	5.6 [1.2 - 6.5]	7.0 [1.2 - 8.0]	8.0 [2.0 - 9.0]	9.5 [3.1 - 11.5]
UK heating	Total	kW	4.34	5.6	6.92	8.55	10.45
COP ¹⁾	Nominal (Min - Max)	W/W	4.82 [4.17 - 5.45]	4.15 [3.55 - 5.45]	4.19 [3.40 - 5.45]	4.00 [3.16 - 5.56]	3.97 [3.43 - 5.54]
SCOP ²⁾			4.9 A++	4.7 A++	4.8 A++	4.7 A++	4.1 A+
Pdesign at -10 °C		kW	3.6	4.5	4.6	5.2	8.0
Input power	Nominal (Min - Max)	kW	0.83 [0.22 - 1.20]	1.35 [0.22 - 1.83]	1.67 [0.22 - 2.35]	2.00 [0.36 - 2.85]	2.39 [0.56 - 3.35]
Annual energy consumption ³⁾		kWh/a	1029	1341	1342	1549	2732
Indoor unit			S-3650PK3E	S-3650PK3E	S-6010PK3E	S-6010PK3E	S-6010PK3E
Air flow	Hi / Med / Lo	m ³ /sec	0.22/0.18/0.15	0.27/0.23/0.18	0.33/0.29/0.24	0.33/0.29/0.24	0.37/0.31/0.25
Moisture removal volume		L/h	0.9	1.8	2.0	3.0	4.8
Sound pressure ⁴⁾	Hi / Med / Lo	dB(A)	35/31/27	40/36/32	47/44/40	47/44/40	49/45/41
Sound power	Hi / Med / Lo	dB(A)	51/47/43	56/52/48	63/60/56	63/60/56	65/61/57
Dimension	H x W x D	mm	302 x 1120 x 236	302 x 1120 x 236	302 x 1120 x 236	302 x 1120 x 236	302 x 1120 x 236
Net weight		kg	13	13	14	14	14
nanoe X Generator			Mark 2	Mark 2	Mark 2	Mark 2	Mark 2
Outdoor unit			U-36PZH3E5	U-50PZH3E5	U-60PZH3E5	U-71PZH3E5	U-100PZH3E5
Power supply		V	220 - 230 - 240	220 - 230 - 240	220 - 230 - 240	220 - 230 - 240	220 - 230 - 240
Maximum fuse size		A	20	20	25	25	35
Current	Cool	A	3.60 - 3.45 - 3.30	5.60 - 5.35 - 5.10	7.40 - 7.10 - 6.80	10.0 - 9.60 - 9.20	14.40 - 13.80 - 13.20
	Heat	A	4.05 - 3.90 - 3.70	6.40 - 6.10 - 5.85	7.75 - 7.40 - 7.10	9.65 - 9.35 - 8.95	11.70 - 11.30 - 10.80
Air flow	Cool / Heat	m ³ /sec	0.57/0.61	0.70/0.70	0.70/0.70	1.02/1.00	1.97/1.80
Sound pressure	Cool / Heat (Hi)	dB(A)	43/44	46/48	47/50	48/50	52/52
Sound power	Cool / Heat (Hi)	dB(A)	62/64	64/67	65/69	65/67	69/69
Dimension	H x W x D	mm	695 x 875 x 320	695 x 875 x 320	695 x 875 x 320	996 x 940 x 340	1416 x 940 x 340
Net weight		kg	42	42	43	65	98
Piping diameter	Liquid pipe	Inch (mm)	1/4 (6.35)	1/4 (6.35)	1/4 (6.35) ⁵⁾	3/8 (9.52)	3/8 (9.52)
	Gas pipe	Inch (mm)	1/2 (12.70)	1/2 (12.70)	1/2 (12.70) ⁶⁾	5/8 (15.88)	5/8 (15.88)
Pipe length range		m	3 - 40	3 - 40	3 - 40	5 - 50	5 - 85
Elevation difference (in / out) ⁷⁾		m	15/30	15/30	15/30	15/30	15/30
Pipe length for additional gas		m	30	30	30	30	30
Additional gas amount		g/m	15	15	15	45	45
Refrigerant (R32) / CO ₂ Eq.		kg / T	1.13/0.76	1.13/0.76	1.15/0.78	1.95/1.32	3.05/2.06
Operating range	Cool Min ~ Max	°C	-15 ~ +46	-15 ~ +46	-15 ~ +46	-15 ~ +48	-20 ~ +48 ⁸⁾
	Heat Min ~ Max	°C	-20 ~ +24	-20 ~ +24	-20 ~ +24	-20 ~ +24	-20 ~ +24
Kit RRP			£ 2.010	£ 2.202	£ 2.572	£ 2.966	£ 3.448
Indoor unit RRP			£ 754	£ 754	£ 981	£ 981	£ 981
Outdoor unit RRP			£ 1.112	£ 1.304	£ 1.447	£ 1.841	£ 2.323
Wired control RRP			£ 144	£ 144	£ 144	£ 144	£ 144

Technical focus

- Modern design with flat face and compact size
- DC fan for better efficiency and control
- Six directional piping outlet
- nanoe™ X (Generator Mark 2= 9.6 trillion hydroxyl radicals/sec) as standard for better indoor air quality
- Wired remote control CZ-RTC6BL allows easy system setting via Bluetooth®
- Easy connection and control of external fan or ERV using the connector PAW-FDC on the indoor unit PCB. The external device can be controlled by the remote control of the Panasonic indoor unit

Closed discharge port

When the unit is turned OFF, the flap closes completely to prevent dust getting into the unit and to keep the equipment clean.

Quiet operation

These units are among the quietest in the industry, making them ideal for hotels and hospitals.

Piping outlet in six directions

Piping outlet is possible in six directions of right, right rear, right bottom, left, left rear and left bottom, making the installation work more flexible.

COMPATIBLE WITH ALL PANASONIC CONNECTIVITY SOLUTIONS. FOR DETAILED INFORMATION GO TO THE CONTROL SYSTEMS SECTION



CZ-RTC5B



CONEX



Optional controller.
CONEX wired remote controller.
CZ-RTC6 - CZ-RTC6BL
- CZ-RTC6BLW



Optional controller.
Infrared remote controller.
CZ-RWS3



Optional Econavi sensor.
CZ-CENSC1

Three phase

			7.1 kW	10.0 kW
Kit			KIT-71PK3ZH8	KIT-100PK3ZH8
Remote controller			CZ-RTC5B	CZ-RTC5B
Cooling capacity	Nominal (Min - Max)	kW	7.1 (2.2 - 9.0)	9.5 (3.1 - 10.5)
UK cooling	Total - Sensible	kW	8.1 - 5.1	9.6 - 5.9
EER ¹⁾	Nominal (Min - Max)	W/W	3.50 (2.69 - 5.79)	3.26 (3.09 - 5.34)
SEER ²⁾			6.7 A++	6.3 A++
P _{design}		kW	7.1	9.5
Input power	Nominal (Min - Max)	kW	2.03 (0.38 - 3.35)	2.91 (0.58 - 3.40)
Annual energy consumption ³⁾		kWh/a	370	526
Heating capacity	Nominal (Min - Max)	kW	8.0 (2.0 - 9.0)	9.5 (3.1 - 11.5)
UK heating	Total	kW	8.55	10.45
COP ¹⁾	Nominal (Min - Max)	W/W	4.00 (3.16 - 5.56)	3.97 (3.43 - 5.54)
SCOP ²⁾			4.7 A++	4.1 A+
P _{design} at -10 °C		kW	5.2	8.0
Input power	Nominal (Min - Max)	kW	2.00 (0.36 - 2.85)	2.39 (0.56 - 3.35)
Annual energy consumption ³⁾		kWh/a	1549	2732
Indoor unit			S-6010PK3E	S-6010PK3E
Air flow	Hi / Med / Lo	m ³ /sec	0.33/0.29/0.24	0.37/0.31/0.25
Moisture removal volume		L/h	3.0	4.8
Sound pressure ⁴⁾	Hi / Med / Lo	dB(A)	47/44/40	49/45/41
Sound power	Hi / Med / Lo	dB(A)	63/60/56	65/61/57
Dimension	H x W x D	mm	302 x 1120 x 236	302 x 1120 x 236
Net weight		kg	14	14
nanoe X Generator			Mark 2	Mark 2
Outdoor unit			U-71PZH3E8	U-100PZH3E8
Power supply		V	380 - 400 - 415	380 - 400 - 415
Maximum fuse size		A	15	15
Current	Cool	A	3.40 - 3.25 - 3.15	4.85 - 4.60 - 4.40
	Heat	A	3.30 - 3.15 - 3.05	4.00 - 3.80 - 3.60
Air flow	Cool / Heat	m ³ /sec	1.02/1.00	1.97/1.80
Sound pressure	Cool / Heat (Hi)	dB(A)	48/50	52/52
Sound power	Cool / Heat (Hi)	dB(A)	65/67	69/69
Dimension	H x W x D	mm	996 x 940 x 340	1416 x 940 x 340
Net weight		kg	65	98
Piping diameter	Liquid pipe	Inch (mm)	3/8 (9.52)	3/8 (9.52)
	Gas pipe	Inch (mm)	5/8 (15.88)	5/8 (15.88)
Pipe length range		m	5 - 50	5 - 85
Elevation difference (in / out) ⁷⁾		m	15/30	15/30
Pipe length for additional gas		m	30	30
Additional gas amount		g/m	45	45
Refrigerant (R32) / CO ₂ , Eq.		kg / T	1.95 / 1.32	3.05 / 2.06
Operating range	Cool Min ~ Max	°C	-15 ~ +48	-20 ~ +48 ⁸⁾
	Heat Min ~ Max	°C	-20 ~ +24	-20 ~ +24
Kit RRP		£	3,019	3,485
Indoor unit RRP		£	981	981
Outdoor unit RRP		£	1,894	2,360
Wired control RRP		£	144	144

1) EER and COP calculation is based in accordance to EN14511. 2) For models below 12 kW, the SEER and SCOP is calculated based on values of EU/626/2011. For models above 12 kW, the $\eta_{h,c} / \eta_{h,h}$ values is calculated based on EN 14825. 3) Factory setting. 4) The sound pressure of the units shows the value measured of the position 1 m in front of the main body and 1 m below the unit. The sound pressure is measured in accordance with Eurovent 6/C/006-97 specification. 5) Connect the liquid socket tube (Ø6.35-Ø9.52) to the liquid tubing side indoor unit. 6) Connect the gas socket tube (Ø12.70-Ø15.88) to the gas tubing side indoor unit. 7) Outdoor unit located lower / outdoor unit located higher. 8) For models 100 ~ 140PZH3E5(8), it is possible to operate the lowest -20 °C in the computer rooms with the piping length of 30 m or less. * Recommended fuse for the indoor 3 A. ** Above values are in the case of nanoe™ X OFF.

Accessories		RRP £
CZ-RTC6L	CONEX wired remote controller (non-wireless)	144
CZ-RTC6BL	CONEX wired remote controller with Bluetooth®	172
CZ-RTC6BLW	CONEX wired remote controller with Wi-Fi and Bluetooth®	242
CZ-RTC5B	Wired remote controller with Econavi function and datanavi	144
CZ-RWS3	Infrared remote controller	108
CZ-CAPWFC1	Commercial Wi-Fi Adaptor	176

Accessories		RRP £
PAW-PACR3	Interfaces to run 3 units on back-up and alternative run	1,745
PAW-WTRAY	Tray for condenser water compatible with outdoor elevation platform	133
PAW-GRDBSE20	Outdoor base ground support for noise and vibration absorption	122
PAW-GRDSTD40	Outdoor elevation platform 400 x 900 x 400 mm	133
CZ-CENSC1	Econavi energy savings sensor	151



SEER and SCOP: For S-3650PK3E + U-36PZH3E5. INTERNET CONTROL: Optional.

Rating Conditions: Cooling Indoor 27 °C DB / 19 °C WB. Cooling Outdoor 35 °C DB / 24 °C WB. Heating Indoor 20 °C DB. Heating Outdoor 7 °C DB / 6 °C WB. (DB: Dry Bulb; WB: Wet Bulb). Specifications subject to change without notice. For detailed information about ErP / Energy Labelling, please visit our websites www.panasonic.co.uk/aircon or www.ptc.panasonic.eu.



nanoe™ X as a standard.



PACi NX Series Standard and Elite 4 way 60x60 cassette Inverter+ · R32

4 way 60x60 cassette - PY3.

- From 2.5 to 6.0 kW (4 capacity sizes)
- SEER / SCOP class A++*
- Built-in drain pump
- DC drain pump and float switch to reduce the noise
- nanoe™ X (Generator Mark 2= 9.6 trillion hydroxyl radicals/sec) as standard for better indoor air quality

* SCOP class A+ in case of 2.5 / 6.0 kW.

Standard			Single phase			
			2.5 kW	3.6 kW	5.0 kW	6.0 kW
Kit			KIT-25PY3Z5	KIT-35PY3Z5	KIT-50PY3Z5	KIT-60PY3Z5
Remote controller			CZ-RTC5B	CZ-RTC5B	CZ-RTC5B	CZ-RTC5B
Cooling capacity	Nominal (Min - Max)	kW	2.5(1.5 - 3.9)	3.6(1.5 - 4.0)	5.0(1.5 - 5.6)	6.0(2.0 - 7.0)
UK cooling	Total - Sensible	kW	2.4 - 1.6	3.4 - 2.3	4.8 - 3.0	5.9 - 3.7
EER ¹⁾	Nominal (Min - Max)	W/W	4.46(3.55 - 5.88)	3.96(3.57 - 5.88)	3.50(3.03 - 6.25)	3.39(2.77 - 6.90)
SEER²⁾			6.5 A++	6.7 A++	7.3 A++	6.8 A++
Pdesign		kW	2.5	3.6	5.0	6.0
Input power	Nominal (Min - Max)	kW	0.56(0.26 - 1.10)	0.91(0.26 - 1.12)	1.43(0.24 - 1.85)	1.77(0.29 - 2.53)
Annual energy consumption ³⁾		kWh/a	134	188	238	3.05
Heating capacity	Nominal (Min - Max)	kW	3.2(1.5 - 4.6)	3.6(1.5 - 4.6)	5.0(1.5 - 6.4)	6.0(1.8 - 7.0)
UK heating	Total	kW	3.6	3.6	5.1	5.7
COP ¹⁾	Nominal (Min - Max)	W/W	4.44(3.41 - 6.52)	4.29(3.38 - 6.52)	3.94(2.91 - 7.50)	3.61(2.86 - 7.60)
SCOP²⁾			4.6 A++	4.3 A+	4.4 A+	4.2 A+
Pdesign at -10 °C		kW	2.8	2.8	4.0	4.6
Input power	Nominal (Min - Max)	kW	0.72(0.23 - 1.35)	0.84(0.23 - 1.36)	1.27(0.20 - 2.20)	1.66(0.24 - 2.45)
Annual energy consumption ³⁾		kWh/a	850	912	1264	1500
Indoor unit			S-25PY3E	S-36PY3E	S-50PY3E	S-60PY3E
Air flow	Hi / Med / Lo	m ³ /sec	0.14/0.12/0.10	0.16/0.12/0.10	0.20/0.16/0.11	0.23/0.18/0.13
Moisture removal volume		L/h	0.7	1.5	2.3	2.8
Sound pressure ⁴⁾	Hi / Med / Lo	dB(A)	31/28/25	34/30/25	39/34/27	43/37/31
Sound power	Hi / Med / Lo	dB(A)	46/43/40	49/45/40	54/49/42	58/52/46
Dimension	Indoor (HxWxD)	mm	243x575x575	243x575x575	243x575x575	243x575x575
	Panel (HxWxD)	mm	30x625x625	30x625x625	30x625x625	30x625x625
Net weight	Indoor / Panel	kg	15/2.8	15/2.8	15/2.8	15/2.8
nanoe X Generator			Mark 2	Mark 2	Mark 2	Mark 2
Outdoor unit			U-25PZ3E5	U-36PZ3E5	U-50PZ3E5	U-60PZ3E5A
Power supply		V	220 - 230 - 240	220 - 230 - 240	220 - 230 - 240	220 - 230 - 240
Maximum fuse size		A	15	15	15	20
Current	Cool	A	2.65 - 2.55 - 2.45	4.20 - 4.05 - 3.85	6.65 - 6.35 - 6.10	8.20 - 7.85 - 7.55
	Heat	A	3.40 - 3.25 - 3.10	3.95 - 3.75 - 3.60	5.695 - 5.70 - 5.45	7.70 - 7.35 - 7.05
Air flow	Cool / Heat	m ³ /sec	0.56/0.57	0.54/0.57	0.55/0.53	0.71/0.69
Sound pressure	Cool / Heat (Hi)	dB(A)	46/47	46/47	46/48	47/48
Sound power	Cool / Heat (Hi)	dB(A)	64/66	64/66	64/64	64/65
Dimension	HxWxD	mm	619x824x299	619x824x299	619x824x299	695x875x320
Net weight		kg	32	32	35	46
Piping diameter	Liquid pipe	Inch (mm)	1/4(6.35)	1/4(6.35)	1/4(6.35)	1/4(6.35) ⁵⁾
	Gas pipe	Inch (mm)	1/2(12.70)	1/2(12.70)	1/2(12.70)	1/2(12.70) ⁴⁾
Pipe length range		m	3 - 15	3 - 15	3 - 20	3 - 40
Elevation difference (in / out) ⁷⁾		m	15/15	15/15	15/15	15/30
Pipe length for additional gas		m	7.5	7.5	7.5	30
Additional gas amount		g/m	10	10	15	15
Refrigerant (R32) / CO ₂ Eq.		kg / T	0.87/0.59	0.87/0.59	1.14/0.77	1.15/0.78
Operating range	Cool Min ~ Max	°C	-10 ~ +43	-10 ~ +43	-10 ~ +43	-10 ~ +43
	Heat Min ~ Max	°C	-15 ~ +24	-15 ~ +24	-15 ~ +24	-15 ~ +24
Kit RRP		£	1.748	1.839	2.160	2.343
Indoor unit RRP		£	655	694	787	961
Outdoor unit RRP		£	716	768	996	1.005
Panel RRP		£	233	233	233	233
Wired control RRP		£	144	144	144	144

Compact and stylish design

- Ceiling depth is only 250 mm
- Exposed area is only 30 mm

Industry-leading energy efficiency

Achieved SEER / SCOP class A++*.

* SCOP class A+ in case of 2.5 / 6.0 kW.

Individual flap control

Better control of the air flow with 4 motors, providing individual flap control.

Perfect air distribution without direct airflow, to reduce the feeling of cold drafts.

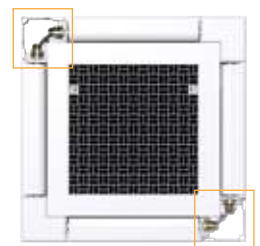

SEER: For S-50PY3E + U-50PZ3E5. SCOP: For S-25PY3E + U-25PZ3E5. ECONAVI and INTERNET CONTROL: Optional.



CZ-RTC5B

Panel.
CZ-KPY4

COMPATIBLE WITH ALL PANASONIC CONNECTIVITY SOLUTIONS. FOR DETAILED INFORMATION GO TO THE CONTROL SYSTEMS SECTION



CONEX



Optional controller.
CONEX wired remote controller.
CZ-RTC6 - CZ-RTC6BL
- CZ-RTC6BLW



Optional controller.
Infrared remote controller.
CZ-RWS3 +
CZ-RRWY3



Optional Econavi sensor.
CZ-CENSC1

Elite			Single phase		
			3.6 kW	5.0 kW	6.0 kW
Kit			KIT-36PY3ZH5	KIT-50PY3ZH5	KIT-60PY3ZH5
Remote controller			CZ-RTC5B	CZ-RTC5B	CZ-RTC5B
Cooling capacity	Nominal (Min - Max)	kW	3.6 (1.2 - 4.0)	5.0 (1.2 - 5.6)	6.0 (1.2 - 6.5)
UK cooling	Total - Sensible	kW	3.5 - 2.3	4.9 - 3.1	5.9 - 3.7
EER ¹⁾	Nominal (Min - Max)	W/W	4.50 (4.04 - 5.45)	3.76 (3.41 - 5.45)	3.43 (2.77 - 5.45)
SEER ²⁾			7.3 A++	7.0 A++	6.7 A++
P _{design}		kW	3.6	5.0	6.0
Input power	Nominal (Min - Max)	kW	0.80 (0.22 - 0.99)	1.33 (0.22 - 1.64)	1.75 (0.20 - 2.35)
Annual energy consumption ³⁾		kWh/a	400	685	875
Heating capacity	Nominal (Min - Max)	kW	4.0 (1.2 - 5.0)	5.6 (1.2 - 6.5)	7.0 (1.2 - 7.5)
UK heating	Total	kW	4.1	5.3	6.1
COP ¹⁾	Nominal (Min - Max)	W/W	4.12 (3.45 - 5.45)	3.37 (2.95 - 5.45)	3.35 (3.38 - 5.45)
SCOP ²⁾			4.7 A++	4.6 A++	4.3 A+
P _{design} at -10 °C		kW	3.6	4.5	4.6
Input power	Nominal (Min - Max)	kW	0.97 (0.22 - 1.45)	1.66 (0.22 - 2.20)	2.09 (0.22 - 2.22)
Annual energy consumption ³⁾		kWh/a	1073	1370	1495
Indoor unit			S-36PY3E	S-50PY3E	S-60PY3E
Air flow	Hi / Med / Lo	m ³ /sec	0.16/0.13/0.10	0.20/0.16/0.11	0.23/0.18/0.13
Moisture removal volume		L/h	1.5	2.5	2.8
Sound pressure ⁴⁾	Hi / Med / Lo	dB(A)	34/30/25	39/34/27	43/37/31
Sound power	Hi / Med / Lo	dB(A)	49/45/40	54/49/42	58/52/46
Dimension	Indoor (H x W x D)	mm	243 x 575 x 575	243 x 575 x 575	243 x 575 x 575
	Panel (H x W x D)	mm	30 x 625 x 625	30 x 625 x 625	30 x 625 x 625
Net weight	Indoor / Panel	kg	15/2.8	15/2.8	15/2.8
nanoe X Generator			Mark 2	Mark 2	Mark 2
Outdoor unit			U-36PZH3E5	U-50PZH3E5	U-60PZH3E5
Power supply		V	220 - 230 - 240	220 - 230 - 240	220 - 230 - 240
Maximum fuse size		A	20	20	25
Current	Cool	A	3.95 - 3.60 - 3.60	5.30 - 5.00 - 5.75	8.20 - 7.85 - 7.60
	Heat	A	4.75 - 4.55 - 4.35	7.85 - 7.50 - 7.20	9.70 - 9.25 - 8.90
Air flow	Cool / Heat	m ³ /sec	0.57/0.61	0.70/0.70	0.70/0.70
Sound pressure	Cool / Heat (Hi)	dB(A)	43/44	46/48	47/50
Sound power	Cool / Heat (Hi)	dB(A)	62/64	64/67	65/69
Dimension	H x W x D	mm	695 x 875 x 320	695 x 875 x 320	695 x 875 x 320
Net weight		kg	42	42	43
Piping diameter	Liquid pipe	Inch (mm)	1/4 (6.35)	1/4 (6.35)	1/4 (6.35) ⁵⁾
	Gas pipe	Inch (mm)	1/2 (12.70)	1/2 (12.70)	1/2 (12.70) ⁶⁾
Pipe length range		m	3 - 40	3 - 40	3 - 40
Elevation difference (in / out) ⁷⁾		m	15/30	15/30	15/30
Pipe length for additional gas		m	30	30	30
Additional gas amount		g/m	15	15	15
Refrigerant (R32) / CO ₂ Eq.		kg / T	1.13/0.76	1.13/0.76	1.15/0.78
Operating range	Cool Min ~ Max	°C	-15 ~ +46	-15 ~ +46	-15 ~ +46
	Heat Min ~ Max	°C	-20 ~ +24	-20 ~ +24	-20 ~ +24
Kit RRP		£	2,183	2,468	2,785
Indoor unit RRP		£	694	787	961
Outdoor unit RRP		£	1,112	1,304	1,447
Panel RRP		£	233	233	233
Wired control RRP		£	144	144	144

1) EER and COP calculation is based in accordance to EN14511. 2) For models below 12 kW, the SEER and SCOP is calculated based on values of EU/626/2011. For models above 12 kW, the $\eta_{h,c}$ / $\eta_{h,w}$ values is calculated based on EN 14825. 3) Factory setting. 4) The sound pressure of the units shows the value measured of the position 1.5 m below the unit. The sound pressure is measured in accordance with Eurovent 6/C/006-97 specification. 5) Connect the liquid socket tube (Ø6.35-Ø9.52) to the liquid tubing side indoor unit. 6) Connect the gas socket tube (Ø12.70-Ø15.88) to the gas tubing side indoor unit. 7) Outdoor unit located lower / outdoor unit located higher. * Recommended fuse for the indoor 3 A. ** Above values are in the case of nanoe™ X OFF.

Accessories		RRP £
CZ-RTC6	CONEX wired remote controller (non-wireless)	144
CZ-RTC6BL	CONEX wired remote controller with Bluetooth®	172
CZ-RTC6BLW	CONEX wired remote controller with Wi-Fi and Bluetooth®	242
CZ-RTC5B	Wired remote controller with Econavi function and datanavi	144
CZ-RWS3 + CZ-RRWY3	Infrared remote controller and receiver	276

Accessories		RRP £
CZ-CAPWFC1	Commercial Wi-Fi Adaptor	176
PAW-PACR3	Interfaces to run 3 units on back-up and alternative run	1,745
PAW-WTRAY	Tray for condenser water compatible with outdoor elevation platform	133
PAW-GRDBSE20	Outdoor base ground support for noise and vibration absorption	122
PAW-GRDSTD40	Outdoor elevation platform 400x900x400 mm	133
CZ-CENSC1	Econavi energy savings sensor	151



SEER and SCOP: For S-36PY3E + U-36PZH3E5. ECONAVI and INTERNET CONTROL: Optional.

Rating Conditions: Cooling Indoor 27 °C DB / 19 °C WB. Cooling Outdoor 35 °C DB / 24 °C WB. Heating Indoor 20 °C DB. Heating Outdoor 7 °C DB / 6 °C WB. (DB: Dry Bulb; WB: Wet Bulb). Specifications subject to change without notice. For detailed information about ErP / Energy Labelling, please visit our websites www.panasonic.co.uk/aircon or www.ptc.panasonic.eu.



nanoe™ X
nanoe™ X as a standard.

PACi NX Series Standard 4 way 90x90 cassette Inverter+ - R32

4 way 90x90 cassette - PU3.

Powerful turbo fan and intelligent Econavi sensor ensure high energy efficiency, and nanoe™ X, which is equipped as standard, provides an exceptional level of indoor air quality.

		Single phase							
		3.6 kW	5.0 kW	6.0 kW	7.1 kW	10.0 kW	12.5 kW	14.0 kW	
Kit		KIT-36PU3Z5	KIT-50PU3Z5	KIT-60PU3Z5	KIT-71PU3Z5	KIT-100PU3Z5	KIT-125PU3Z5	KIT-140PU3Z5	
Remote controller		CZ-RTC5B	CZ-RTC5B	CZ-RTC5B	CZ-RTC5B	CZ-RTC5B	CZ-RTC5B	CZ-RTC5B	
Cooling capacity	Nominal (Min - Max)	kW	3.6(1.5 - 4.0)	5.0(1.5 - 5.6)	6.0(2.0 - 7.1)	7.1(2.6 - 7.7)	10.0(3.0 - 11.5)	12.5(3.2 - 13.5)	14.0(3.3 - 15.0)
UK cooling	Total - Sensible	kW	3.4 - 2.6	4.8 - 3.3	5.9 - 4.1	6.7 - 4.4	10.7 - 7.6	12.6 - 8.4	13.9 - 9.2
EER ¹⁾	Nominal (Min - Max)	W/W	4.34(5.88-3.81)	3.91(6.25-3.20)	3.73(6.90-3.01)	3.27(5.00-2.77)	3.82(2.88 - 5.36)	3.58(2.81 - 5.33)	3.23(2.73 - 5.32)
SEER / η_{sc}²⁾			8.1 A++	8.0 A++	7.8 A++	6.8 A++	6.8 A++	267.0 %	257.0 %
Pdesign		kW	3.6	5.0	6.0	7.1	10.0	12.5	14.0
Input power	Nominal (Min - Max)	kW	0.83(0.25-1.05)	1.28(0.24-1.75)	1.61(0.29-2.36)	2.17(0.52-2.78)	2.62(0.56 - 4.00)	3.49(0.60 - 4.80)	4.34(0.62 - 5.50)
Annual energy consumption ³⁾		kWh/a	156	219	269	365	515	—	—
Heating capacity	Nominal (Min - Max)	kW	3.6(1.5 - 4.6)	5.0(1.5 - 6.4)	6.0(1.8 - 7.0)	7.1(2.1 - 8.1)	10.0(3.0 - 14.0)	12.5(3.3 - 15.0)	14.0(3.4 - 16.0)
UK heating	Total	kW	3.9	5.6	6.2	6.9	12.7	14.7	15.22
COP ¹⁾	Nominal (Min - Max)	W/W	5.07(4.32 - 6.52)	4.63(3.48 - 7.50)	4.48(3.18 - 7.50)	4.23(3.38 - 6.36)	4.93(3.59 - 5.36)	4.43(3.57 - 5.50)	4.18(3.33 - 5.48)
SCOP / η_{sh}²⁾			4.8 A++	4.7 A++	4.9 A++	4.6 A++	4.4 A+	157.0 %	152.2 %
Pdesign at -10 °C		kW	2.8	4.0	4.6	5.2	10.0	12.5	14.0 (at -7 °C)
Input power	Nominal (Min - Max)	kW	0.71(0.23-1.06)	1.08(0.20-1.84)	1.34(0.24-2.20)	1.68(0.33-2.40)	2.03(0.56 - 3.90)	2.82(0.60 - 4.20)	3.35(0.62 - 4.80)
Annual energy consumption ³⁾		kWh/a	817	1191	1314	1583	3182	—	—
Indoor unit			S-3650PU3E	S-3650PU3E	S-6071PU3E	S-6071PU3E	S-1014PU3E	S-1014PU3E	S-1014PU3E
Air flow	Hi / Med / Lo	m ³ /sec	0.24/0.22/0.19	0.28/0.23/0.19	0.35/0.27/0.22	0.37/0.27/0.22	0.60/0.43/0.30	0.62/0.45/0.32	0.63/0.48/0.33
Moisture removal volume		L/h	0.7	1.6	1.7	2.5	2.7	4.8	6.0
Sound pressure ⁴⁾	Hi / Med / Lo	dB(A)	30/28/27	32/29/27	36/31/28	37/31/28	45/38/32	46/39/33	47/40/34
Sound power	Hi / Med / Lo	dB(A)	45/43/42	47/44/42	51/46/43	52/46/43	60/53/47	61/54/48	62/55/49
Dimension	Indoor (H x W x D)	mm	256 x 840 x 840	256 x 840 x 840	256 x 840 x 840	256 x 840 x 840	319 x 840 x 840	319 x 840 x 840	319 x 840 x 840
	Panel (H x W x D)	mm	33.5 x 950 x 950	33.5 x 950 x 950	33.5 x 950 x 950	33.5 x 950 x 950	33.5 x 950 x 950	33.5 x 950 x 950	33.5 x 950 x 950
Net weight	Indoor / Panel	kg	19/5	19/5	20/5	20/5	25/5	25/5	25/5
nanoe X Generator			Mark 1	Mark 1	Mark 1	Mark 1	Mark 1	Mark 1	
Outdoor unit			U-36PZ3E5	U-50PZ3E5	U-60PZ3E5A	U-71PZ3E5A	U-100PZ3E5	U-125PZ3E5	U-140PZ3E5
Power supply		V	220 - 230 - 240	220 - 230 - 240	220 - 230 - 240	220 - 230 - 240	220 - 230 - 240	220 - 230 - 240	220 - 230 - 240
Maximum fuse size		A	15	15	20	20	35	40	40
Current	Cool	A	3.85 - 3.70 - 3.55	5.95 - 5.70 - 5.45	7.45 - 7.15 - 6.85	10.00 - 9.65 - 9.25	13.10 - 12.50 - 12.00	16.90 - 16.10 - 15.40	21.00 - 20.00 - 19.20
	Heat	A	3.35 - 3.20 - 3.05	5.05 - 4.85 - 4.65	6.20 - 5.95 - 5.70	7.80 - 7.45 - 7.15	10.10 - 9.70 - 9.30	13.60 - 13.00 - 12.50	16.20 - 15.50 - 14.80
Air flow	Cool / Heat	m ³ /sec	0.56/0.57	0.55/0.53	0.71/0.69	0.75/0.77	1.22/1.22	1.37/1.33	1.40/1.37
Sound pressure	Cool / Heat (Hi)	dB(A)	46/47	46/46	47/48	48/49	52/52	55/55	56/56
Sound power	Cool / Heat (Hi)	dB(A)	64/66	64/64	64/65	66/68	70/70	73/73	74/74
Dimension	H x W x D	mm	619 x 824 x 299	619 x 824 x 299	695 x 875 x 320	695 x 875 x 320	996 x 980 x 370	996 x 980 x 370	996 x 980 x 370
Net weight		kg	32	35	42	50	83	87	87
Piping diameter	Liquid pipe	Inch (mm)	1/4(6.35)	1/4(6.35)	1/4(6.35) ⁵⁾	1/4(6.35) ⁵⁾	3/8(9.52)	3/8(9.52)	3/8(9.52)
	Gas pipe	Inch (mm)	1/2(12.70)	1/2(12.70)	1/2(12.70) ⁴⁾	5/8(15.88)	5/8(15.88)	5/8(15.88)	5/8(15.88)
Pipe length range		m	3 - 15	3 - 20	3 - 40	3 - 40	5 - 50	5 - 50	5 - 50
Elevation difference (in / out) ⁷⁾		m	15/15	15/15	15/30	20/30	15/30	15/30	15/30
Pipe length for additional gas		m	7.5	7.5	30	30	30	30	30
Additional gas amount		g/m	10	15	15	17	45	45	45
Refrigerant (R32) / CO ₂ Eq.		kg / T	0.87/0.59	1.14/0.77	1.15/0.78	1.32/0.89	2.40/1.62	2.80/1.89	2.80/1.89
Operating range	Cool Min - Max	°C	-10 ~ +43	-10 ~ +43	-10 ~ +43	-10 ~ +43	-10 ~ +43	-10 ~ +43	-10 ~ +43
	Heat Min - Max	°C	-15 ~ +24	-15 ~ +24	-15 ~ +24	-15 ~ +24	-15 ~ +24	-15 ~ +24	-15 ~ +24
Kit RRP		£	1.679	1.907	2.214	2.511	2.989	3.297	3.928
Indoor unit RRP		£	563	563	861	861	1,046	1,046	1,046
Outdoor unit RRP		£	768	996	1,005	1,302	1,595	1,903	2,534
Panel RRP		£	204	204	204	204	204	204	204
Wired control RRP		£	144	144	144	144	144	144	144

Technical focus

- High performance turbo fan
- Econavi: An optional intelligent sensor to reduce waste of energy
- nanoe™ X (Generator Mark 1= 4.8 trillion hydroxyl radicals/sec) as standard for better indoor air quality, indoor unit internal cleaning with nanoe™ X and dry operation
- Lower noise in slow fan operation
- Light weight, easy piping and integrated drain pump for quick installation
- Wired remote control CZ-RTC6BL allows easy system setting via Bluetooth®
- High volume fresh air input with optional air-intake plenum and chamber (CZ-FDU3+CZ-ATU2)



COMPATIBLE WITH ALL PANASONIC CONNECTIVITY SOLUTIONS. FOR DETAILED INFORMATION GO TO THE CONTROL SYSTEMS SECTION



Optional Econavi panel (CZ-RTC5B is required).
CZ-KPU3AW



Optional controller. CONEX wired remote controller.
CZ-RTC6 - CZ-RTC6BL - CZ-RTC6BLW



Optional controller. Infrared remote controller.
CZ-RWS3 + CZ-RWRU3W

Kit	10.0 kW			Three phase		
	KIT-100PU3Z8			KIT-125PU3Z8		
Remote controller	CZ-RTC5B			CZ-RTC5B		
Cooling capacity	Nominal (Min - Max)	kW	10.0(3.0 - 11.5)	12.5(3.2 - 13.5)	14.0(3.3 - 15.0)	
UK cooling	Total - Sensible	kW	10.7 - 7.6	12.6 - 8.4	13.9 - 9.2	
EER ¹⁾	Nominal (Min - Max)	W/W	3.82(2.88 - 5.36)	3.58(2.81 - 5.33)	3.23(2.73 - 5.32)	
SEER / $\eta_{s,c}$ ²⁾			6.7 A++	265.8 %	256.2 %	
Pdesign		kW	10.0	12.5	14.0	
Input power	Nominal (Min - Max)	kW	2.62(0.56 - 4.00)	3.49(0.60 - 4.80)	4.34(0.62 - 5.50)	
Annual energy consumption ³⁾		kWh/a	521	—	—	
Heating capacity	Nominal (Min - Max)	kW	10.0(3.0 - 14.0)	12.5(3.3 - 15.0)	14.0(3.4 - 16.0)	
UK heating	Total	kW	12.6	14.7	15.2	
COP ¹⁾	Nominal (Min - Max)	W/W	4.93(3.59 - 5.36)	4.43(3.57 - 5.50)	4.18(3.33 - 5.48)	
SCOP / $\eta_{s,h}$ ²⁾			4.4 A+	157.0 %	152.2 %	
Pdesign at -10 °C		kW	10.0	12.5	14.0 (at -7 °C)	
Input power	Nominal (Min - Max)	kW	2.03(0.56 - 3.90)	2.82(0.60 - 4.20)	3.35(0.62 - 4.80)	
Annual energy consumption ³⁾		kWh/a	3182	—	—	
Indoor unit			S-1014PU3E	S-1014PU3E	S-1014PU3E	
Air flow	Hi / Med / Lo	m ³ /sec	0.60/0.43/0.30	0.62/0.45/0.32	0.63/0.48/0.33	
Moisture removal volume		L/h	2.7	4.8	6.0	
Sound pressure ⁴⁾	Hi / Med / Lo	dB(A)	45/38/32	46/39/33	47/40/34	
Sound power	Hi / Med / Lo	dB(A)	60/53/47	61/54/48	62/55/49	
Dimension	Indoor (H x W x D)	mm	319 x 840 x 840	319 x 840 x 840	319 x 840 x 840	
	Panel (H x W x D)	mm	33.5 x 950 x 950	33.5 x 950 x 950	33.5 x 950 x 950	
Net weight	Indoor / Panel	kg	25/5	25/5	25/5	
nanoe X Generator			Mark 1	Mark 1	Mark 1	
Outdoor unit			U-100PZ3E8	U-125PZ3E8	U-140PZ3E8	
Power supply		V	380 - 400 - 415	380 - 400 - 415	380 - 400 - 415	
Maximum fuse size		A	15	20	20	
Current	Cool	A	4.35 - 4.15 - 4.00	5.65 - 5.35 - 5.15	7.00 - 6.65 - 6.40	
	Heat	A	3.40 - 3.20 - 3.10	4.55 - 4.35 - 4.15	5.40 - 5.15 - 4.95	
Air flow	Cool / Heat	m ³ /sec	1.22/1.22	1.37/1.33	1.40/1.37	
Sound pressure	Cool / Heat (Hi)	dB(A)	52/52	55/55	56/56	
Sound power	Cool / Heat (Hi)	dB(A)	70/70	73/73	74/74	
Dimension	H x W x D	mm	996 x 980 x 370	996 x 980 x 370	996 x 980 x 370	
Net weight		kg	83	87	87	
Piping diameter	Liquid pipe	Inch (mm)	3/8(9.52)	3/8(9.52)	3/8(9.52)	
	Gas pipe	Inch (mm)	5/8(15.88)	5/8(15.88)	5/8(15.88)	
Pipe length range		m	5 - 50	5 - 50	5 - 50	
Elevation difference (in / out) ⁷⁾		m	15/30	15/30	15/30	
Pipe length for additional gas		m	30	30	30	
Additional gas amount		g/m	45	45	45	
Refrigerant (R32) / CO ₂ Eq.		kg / T	2.40/1.62	2.80/1.89	2.80/1.89	
Operating range	Cool Min ~ Max	°C	-10 ~ +43	-10 ~ +43	-10 ~ +43	
	Heat Min ~ Max	°C	-15 ~ +24	-15 ~ +24	-15 ~ +24	
Kit RRP		£	3,087	3,357	3,958	
Indoor unit RRP		£	1,046	1,046	1,046	
Outdoor unit RRP		£	1,693	1,963	2,564	
Panel RRP		£	204	204	204	
Wired control RRP		£	144	144	144	

1) EER and COP calculation is based in accordance to EN14511. 2) For models below 12 kW, the SEER and SCOP is calculated based on values of EU/626/2011. For models above 12 kW, the $\eta_{s,c}$ / $\eta_{s,h}$ values is calculated based on EN 14825. 3) Factory setting. 4) The sound pressure of the units shows the value measured of the position 1.5 m below the unit. The sound pressure is measured in accordance with Eurovent 6/C/006-97 specification. 5) Connect the liquid socket tube (Ø6.35-Ø9.52) to the liquid tubing side indoor unit. 6) Connect the gas socket tube (Ø12.70-Ø15.88) to the gas tubing side indoor unit. 7) Outdoor unit located lower / outdoor unit located higher. * Recommended fuse for the indoor 3 A. ** Above values are in the case of nanoe™ X OFF.

Accessories	RRP £
CZ-RTC6 CONEX wired remote controller (non-wireless)	144
CZ-RTC6BL CONEX wired remote controller with Bluetooth®	172
CZ-RTC6BLW CONEX wired remote controller with Wi-Fi and Bluetooth®	242
CZ-RTC5B Wired remote controller with Econavi function and datanavi	144
CZ-RWS3 + CZ-RWRU3W Infrared remote controller and receiver	276
CZ-CAPWFC1 Commercial Wi-Fi Adaptor	176

Accessories	RRP £
CZ-KPU3AW Econavi exclusive panel	278
PAW-PACR3 Interfaces to run 3 units on back-up and alternative run	1,745
PAW-WTRAY Tray for condenser water compatible with outdoor elevation platform	133
PAW-GRDBSE20 Outdoor base ground support for noise and vibration absorption	122
PAW-GRDSTD40 Outdoor elevation platform 400 x 900 x 400 mm	133
CZ-FDU3+CZ-ATU2 Fresh air-intake kit	786



SEER: For S-3650PU3E + U-36PZ3E5. SCOP: For S-6071PU3E + U-60PZ3E5A. ECONAVI and INTERNET CONTROL: Optional.

Rating Conditions: Cooling Indoor 27 °C DB / 19 °C WB. Cooling Outdoor 35 °C DB / 24 °C WB. Heating Indoor 20 °C DB. Heating Outdoor 7 °C DB / 4 °C WB. (DB: Dry Bulb; WB: Wet Bulb). Specifications subject to change without notice. For detailed information about ErP / Energy Labelling, please visit our websites www.panasonic.co.uk/aircon or www.ptc.panasonic.eu.



PACi NX Series Elite 4 way 90x90 cassette Inverter+ · R32

4 way 90x90 cassette - PU3.

Powerful turbo fan and intelligent Econavi sensor ensure high energy efficiency, and nanoe™ X, which is equipped as standard, provides an exceptional level of indoor air quality.

		Single phase							
		3.6 kW	5.0 kW	6.0 kW	7.1 kW	10.0 kW	12.5 kW	14.0 kW	
Kit		KIT-36PU3ZH5	KIT-50PU3ZH5	KIT-60PU3ZH5	KIT-71PU3ZH5	KIT-100PU3ZH5	KIT-125PU3ZH5	KIT-140PU3ZH5	
Remote controller		CZ-RTC5B	CZ-RTC5B	CZ-RTC5B	CZ-RTC5B	CZ-RTC5B	CZ-RTC5B	CZ-RTC5B	
Cooling capacity	Nominal (Min - Max)	kW	3.6(1.2 - 4.0)	5.0(1.2 - 5.6)	6.0(1.2 - 7.1)	7.1(2.2 - 9.0)	10.0(3.1 - 12.5)	12.5(3.2 - 14.0)	14.0(3.3 - 16.0)
UK cooling	Total - Sensible	kW	3.5 - 2.6	4.9 - 3.4	5.9 - 4.1	8.4 - 5.4	11.4 - 7.9	12.8 - 8.5	14.6 - 9.6
EER ¹⁾	Nominal (Min - Max)	W/W	5.45(4.60 - 5.45)	4.31(3.86 - 5.45)	4.05(3.02 - 5.45)	4.06(2.69 - 5.79)	4.41(3.42 - 5.34)	3.80(3.08 - 5.33)	3.41(2.74 - 5.32)
SEER / η _{sc} ²⁾			8.9 A+++	8.6 A+++	8.0 A++	7.7 A++	7.8 A++	304.3 %	286.6 %
Pdesign		kW	3.6	5.0	6.0	7.1	10.0	12.5	14.0
Input power	Nominal (Min - Max)	kW	0.66(0.22 - 0.87)	1.16(0.22 - 1.45)	1.48(0.22 - 2.35)	1.75(0.38 - 3.35)	2.27(0.58 - 3.66)	3.29(6.00 - 4.55)	4.11(0.62 - 5.85)
Annual energy consumption ³⁾		kWh/a	142	203	263	323	449	—	—
Heating capacity	Nominal (Min - Max)	kW	4.0(1.2 - 5.0)	5.6(1.2 - 6.5)	7.0(1.2 - 8.0)	8.0(2.0 - 9.0)	11.2(3.1 - 14.0)	14.0(3.2 - 16.0)	16.0(3.3 - 18.0)
UK heating	Total	kW	4.34	5.6	6.92	8.55	12.65	14.5	16.35
COP ¹⁾	Nominal (Min - Max)	W/W	5.41(4.55 - 5.45)	4.24(4.19 - 5.45)	4.02(3.40 - 5.45)	4.30(3.16 - 5.56)	5.00(3.64 - 5.54)	4.61(3.37 - 5.52)	4.30(3.27 - 5.50)
SCOP / η _{sh} ²⁾			5.1 A+++	4.9 A++	4.8 A++	4.8 A++	4.9 A++	186.0 %	181.2 %
Pdesign at -10 °C		kW	3.6	4.5	4.7	5.2	8.0	9.5	10.6
Input power	Nominal (Min - Max)	kW	0.74(0.22 - 1.10)	1.32(0.22 - 1.55)	1.74(0.22 - 2.35)	1.86(0.36 - 2.85)	2.24(0.56 - 3.85)	3.04(0.58 - 4.75)	3.72(0.60 - 5.50)
Annual energy consumption ³⁾		kWh/a	988	1286	1371	1517	2286	—	—
Indoor unit			S-3650PU3E	S-3650PU3E	S-6071PU3E	S-6071PU3E	S-1014PU3E	S-1014PU3E	S-1014PU3E
Air flow	Hi / Med / Lo	m ³ /sec	0.24/0.22/0.19	0.28/0.23/0.19	0.35/0.27/0.22	0.37/0.27/0.22	0.60/0.43/0.30	0.62/0.45/0.32	0.63/0.48/0.33
Moisture removal volume		L/h	0.7	1.6	1.7	2.5	2.7	4.8	6.0
Sound pressure ⁴⁾	Hi / Med / Lo	dB(A)	30/28/27	32/29/27	36/31/28	37/31/28	45/38/32	46/39/33	47/40/34
Sound power	Hi / Med / Lo	dB(A)	45/43/42	47/44/42	51/46/43	52/46/43	60/53/47	61/54/48	62/55/49
Dimension	Indoor (H x W x D)	mm	256 x 840 x 840	256 x 840 x 840	256 x 840 x 840	256 x 840 x 840	319 x 840 x 840	319 x 840 x 840	319 x 840 x 840
	Panel (H x W x D)	mm	33.5 x 950 x 950	33.5 x 950 x 950	33.5 x 950 x 950	33.5 x 950 x 950	33.5 x 950 x 950	33.5 x 950 x 950	33.5 x 950 x 950
Net weight	Indoor / Panel	kg	19/5	19/5	20/5	20/5	25/5	25/5	25/5
nanoe X Generator			Mark 1	Mark 1	Mark 1	Mark 1	Mark 1	Mark 1	Mark 1
Outdoor unit			U-36PZH3E5	U-50PZH3E5	U-60PZH3E5	U-71PZH3E5	U-100PZH3E5	U-125PZH3E5	U-140PZH3E5
Power supply		V	220 - 230 - 240	220 - 230 - 240	220 - 230 - 240	220 - 230 - 240	220 - 230 - 240	220 - 230 - 240	220 - 230 - 240
Maximum fuse size		A	20	20	25	25	35	35	40
Current	Cool	A	3.25 - 3.10 - 3.00	5.50 - 5.25 - 5.05	6.95 - 6.65 - 6.35	8.65 - 8.25 - 7.95	11.20 - 10.70 - 10.30	16.10 - 15.40 - 14.70	20.10 - 19.20 - 18.40
	Heat	A	3.60 - 3.45 - 3.30	6.25 - 6.00 - 5.75	8.05 - 7.70 - 7.40	9.00 - 8.70 - 8.35	10.90 - 10.60 - 10.10	14.90 - 14.20 - 13.60	18.20 - 17.40 - 16.70
Air flow	Cool / Heat	m ³ /sec	0.57/0.61	0.70/0.70	0.70/0.70	1.02/1.00	1.97/1.80	2.08/1.87	2.15/1.93
Sound pressure	Cool / Heat (Hi)	dB(A)	43/44	46/48	47/50	48/50	52/52	53/53	54/54
Sound power	Cool / Heat (Hi)	dB(A)	62/64	64/67	65/69	65/67	69/69	70/70	71/71
Dimension	H x W x D	mm	695 x 875 x 320	695 x 875 x 320	695 x 875 x 320	996 x 940 x 340	1416 x 940 x 340	1416 x 940 x 340	1416 x 940 x 340
Net weight		kg	42	42	43	65	98	98	98
Piping diameter	Liquid pipe	Inch (mm)	1/4 (6.35)	1/4 (6.35)	1/4 (6.35) ⁵⁾	3/8 (9.52)	3/8 (9.52)	3/8 (9.52)	3/8 (9.52)
	Gas pipe	Inch (mm)	1/2 (12.70)	1/2 (12.70)	1/2 (12.70) ⁶⁾	5/8 (15.88)	5/8 (15.88)	5/8 (15.88)	5/8 (15.88)
Pipe length range		m	3 - 40	3 - 40	3 - 40	5 - 50	5 - 85	5 - 85	5 - 85
Elevation difference (in / out) ⁷⁾		m	15/30	15/30	15/30	15/30	15/30	15/30	15/30
Pipe length for additional gas		m	30	30	30	30	30	30	30
Additional gas amount		g/m	15	15	15	45	45	45	45
Refrigerant (R32) / CO ₂ Eq.		kg / T	1.13/0.76	1.13/0.76	1.15/0.78	1.95/1.32	3.05/2.06	3.05/2.06	3.05/2.06
Operating range	Cool Min - Max	°C	-15 ~ +46	-15 ~ +46	-15 ~ +46	-15 ~ +48	-20 ~ +48 ⁸⁾	-20 ~ +48 ⁸⁾	-20 ~ +48 ⁸⁾
	Heat Min - Max	°C	-20 ~ +24	-20 ~ +24	-20 ~ +24	-20 ~ +24	-20 ~ +24	-20 ~ +24	-20 ~ +24
Kit RRP		£	2.023	2.215	2.656	3.050	3.717	3.991	4.431
Indoor unit RRP		£	563	563	861	861	1,046	1,046	1,046
Outdoor unit RRP		£	1,112	1,304	1,447	1,841	2,323	2,597	3,037
Panel RRP		£	204	204	204	204	204	204	204
Wired control RRP		£	144	144	144	144	144	144	144

Technical focus

- High performance turbo fan
- Econavi: An optional intelligent sensor to reduce waste of energy
- nanoe™ X (Generator Mark 1= 4.8 trillion hydroxyl radicals/sec) as standard for better indoor air quality, indoor unit internal cleaning with nanoe™ X and dry operation
- Lower noise in slow fan operation
- Light weight, easy piping and integrated drain pump for quick installation
- Wired remote control CZ-RTC6BL allows easy system setting via Bluetooth®
- High volume fresh air input with optional air-intake plenum and chamber (CZ-FDU3+CZ-ATU2)

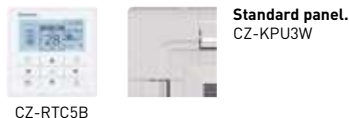

Standard panel.
CZ-KPU3W

CZ-RTC5B



Optional
Econavi panel
(CZ-RTC5B is
required).
CZ-KPU3AW



Optional controller.
CONEX wired remote
controller.
CZ-RTC6 - CZ-RTC6BL
- CZ-RTC6BLW



Optional controller.
Infrared remote
controller.
CZ-RWS3 +
CZ-RWRU3W

COMPATIBLE WITH ALL PANASONIC
CONNECTIVITY SOLUTIONS. FOR
DETAILED INFORMATION GO TO THE
CONTROL SYSTEMS SECTION

Three phase

		7.1 kW		10.0 kW		12.5 kW		14.0 kW			
Kit		KIT-71PU3ZH8		KIT-100PU3ZH8		KIT-125PU3ZH8		KIT-140PU3ZH8			
Remote controller		CZ-RTC5B		CZ-RTC5B		CZ-RTC5B		CZ-RTC5B			
Cooling capacity	Nominal (Min - Max)	kW		7.1 [2.2 - 9.0]		10.0 [3.1 - 12.5]		12.5 [3.2 - 14.0]		14.0 [3.3 - 16.0]	
UK cooling	Total - Sensible	kW		8.4 - 5.4		11.4 - 7.9		12.8 - 8.5		14.6 - 9.6	
EER ¹⁾	Nominal (Min - Max)	W/W		4.06 [2.69 - 5.79]		4.41 [3.42 - 5.34]		3.80 [3.08 - 5.33]		3.41 [2.74 - 5.82]	
SEER / $\eta_{s,c}$ ²⁾		7.6 A++		7.7 A++		303.3 %		285.6 %			
P _{design}		kW		7.1		10.0		12.5		14.0	
Input power	Nominal (Min - Max)	kW		1.75 [0.38 - 3.35]		2.27 [0.58 - 3.65]		3.29 [0.60 - 4.55]		4.11 [0.62 - 5.85]	
Annual energy consumption ³⁾		kWh/a		327		455		—		—	
Heating capacity	Nominal (Min - Max)	kW		8.0 [2.0 - 9.0]		11.2 [3.1 - 14.0]		14.0 [3.2 - 16.0]		16.0 [3.3 - 18.0]	
UK heating	Total	kW		8.55		12.65		14.5		16.35	
COP ¹⁾	Nominal (Min - Max)	W/W		4.30 [3.16 - 5.56]		5.00 [3.64 - 5.54]		4.61 [3.27 - 5.52]		4.30 [3.27 - 5.50]	
SCOP / $\eta_{s,h}$ ²⁾		4.8 A++		4.9 A++		186.0 %		181.1 %			
P _{design} at -10 °C		kW		5.2		8.0		9.5		10.6	
Input power	Nominal (Min - Max)	kW		1.86 [0.36 - 2.85]		2.24 [0.56 - 3.85]		3.04 [0.58 - 4.75]		3.72 [0.60 - 5.50]	
Annual energy consumption ³⁾		kWh/a		1517		2286		—		—	
Indoor unit		S-6071PU3E		S-1014PU3E		S-1014PU3E		S-1014PU3E		S-1014PU3E	
Air flow	Hi / Med / Lo	m ³ /sec		0.37/0.27/0.22		0.60/0.43/0.30		0.62/0.45/0.32		0.63/0.48/0.33	
Moisture removal volume		L/h		2.5		2.7		4.8		6.0	
Sound pressure ⁴⁾	Hi / Med / Lo	dB(A)		37/31/28		45/38/32		46/39/33		47/40/34	
Sound power	Hi / Med / Lo	dB(A)		52/46/43		60/53/47		61/54/48		62/55/49	
Dimension	Indoor (H x W x D)	mm		256 x 840 x 840		319 x 840 x 840		319 x 840 x 840		319 x 840 x 840	
	Panel (H x W x D)	mm		33.5 x 950 x 950		33.5 x 950 x 950		33.5 x 950 x 950		33.5 x 950 x 950	
Net weight	Indoor / Panel	kg		20/5		25/5		25/5		25/5	
nanoe X Generator		Mark 1		Mark 1		Mark 1		Mark 1		Mark 1	
Outdoor unit		U-71PZH3E8		U-100PZH3E8		U-125PZH3E8		U-140PZH3E8		U-140PZH3E8	
Power supply		V		380 - 400 - 415		380 - 400 - 415		380 - 400 - 415		380 - 400 - 415	
Maximum fuse size		A		15		15		15		15	
Current	Cool	A		2.90 - 2.80 - 2.70		3.80 - 3.60 - 3.45		5.45 - 5.15 - 5.00		6.80 - 6.45 - 6.20	
	Heat	A		3.05 - 2.95 - 2.85		3.75 - 3.55 - 3.40		5.10 - 4.80 - 4.65		6.20 - 5.90 - 5.65	
Air flow	Cool / Heat	m ³ /sec		1.02/1.00		1.97/1.80		2.08/1.87		2.15/1.93	
Sound pressure	Cool / Heat (Hi)	dB(A)		48/50		52/52		53/53		54/54	
Sound power	Cool / Heat (Hi)	dB(A)		65/67		69/69		70/70		71/71	
Dimension	H x W x D	mm		996 x 940 x 340		1416 x 940 x 340		1416 x 940 x 340		1416 x 940 x 340	
Net weight		kg		65		98		98		98	
Piping diameter	Liquid pipe	Inch (mm)		3/8 (9.52)		3/8 (9.52)		3/8 (9.52)		3/8 (9.52)	
	Gas pipe	Inch (mm)		5/8 (15.88)		5/8 (15.88)		5/8 (15.88)		5/8 (15.88)	
Pipe length range		m		5 - 50		5 - 85		5 - 85		5 - 85	
Elevation difference (in / out) ⁷⁾		m		15/30		15/30		15/30		15/30	
Pipe length for additional gas		m		30		30		30		30	
Additional gas amount		g/m		45		45		45		45	
Refrigerant (R32) / CO ₂ Eq.		kg / T		1.95/1.32		3.05/2.06		3.05/2.06		3.05/2.06	
Operating range	Cool Min ~ Max	°C		-15 ~ +48		-20 ~ +48 ⁸⁾		-20 ~ +48 ⁸⁾		-20 ~ +48 ⁸⁾	
	Heat Min ~ Max	°C		-20 ~ +24		-20 ~ +24		-20 ~ +24		-20 ~ +24	
Kit RRP		£		3.103		3.754		4.107		4.750	
Indoor unit RRP		£		861		1.046		1.046		1.046	
Outdoor unit RRP		£		1.894		2.360		2.713		3.356	
Panel RRP		£		204		204		204		204	
Wired control RRP		£		144		144		144		144	

1) EER and COP calculation is based in accordance to EN14511. 2) For models below 12 kW, the SEER and SCOP is calculated based on values of EU/626/2011. For models above 12 kW, the $\eta_{s,c}$ / $\eta_{s,h}$ values is calculated based on EN 14825. 3) Factory setting. 4) The sound pressure of the units shows the value measured of the position 1.5 m below the unit. The sound pressure is measured in accordance with Eurovent 6/C/006-97 specification. 5) Connect the liquid socket tube (Ø6.35-Ø9.52) to the liquid tubing side indoor unit. 6) Connect the gas socket tube (Ø12.70-Ø15.88) to the gas tubing side indoor unit. 7) Outdoor unit located lower / outdoor unit located higher. 8) For models 100 - 140PZH3E5(8), it is possible to operate the lowest -20 °C in the computer rooms with the piping length of 30 m or less. * Recommended fuse for the indoor 3 A. ** Above values are in the case of nanoe™ X OFF.

Accessories		RRP £
CZ-RTC6	CONEX wired remote controller (non-wireless)	144
CZ-RTC6BL	CONEX wired remote controller with Bluetooth®	172
CZ-RTC6BLW	CONEX wired remote controller with Wi-Fi and Bluetooth®	242
CZ-RTC5B	Wired remote controller with Econavi function and datanavi	144
CZ-RWS3 + CZ-RWRU3W	Infrared remote controller and receiver	276
CZ-CAPWFC1	Commercial Wi-Fi Adaptor	176

Accessories		RRP £
CZ-KPU3AW	Econavi exclusive panel	278
PAW-PACR3	Interfaces to run 3 units on back-up and alternative run	1.745
PAW-WTRAY	Tray for condenser water compatible with outdoor elevation platform	133
PAW-GRDBSE20	Outdoor base ground support for noise and vibration absorption	122
PAW-GRDSTD40	Outdoor elevation platform 400x900x400 mm	133
CZ-FDU3+CZ-ATU2	Fresh air-intake kit	786



SEER and SCOP: For S-3650PU3E + U-36PZH3E5. ECONAVI and INTERNET CONTROL: Optional.

Rating Conditions: Cooling Indoor 27 °C DB / 19 °C WB. Cooling Outdoor 35 °C DB / 24 °C WB. Heating Indoor 20 °C DB. Heating Outdoor 7 °C DB / 6 °C WB. (DB: Dry Bulb; WB: Wet Bulb). Specifications subject to change without notice. For detailed information about ErP / Energy Labelling, please visit our websites www.panasonic.co.uk/aircon or www.ptc.panasonic.eu.



PACi NX Series Standard ceiling Inverter+ · R32

Ceiling mounted units provide large and wide air distribution which is good for big rooms.

The height and depth of all capacities are the same for unified appearance in mixed installations.

		Single phase							
		3.6 kW	5.0 kW	6.0 kW	7.1 kW	10.0 kW	12.5 kW	14.0 kW	
Kit		KIT-36PT3Z5	KIT-50PT3Z5	KIT-60PT3Z5	KIT-71PT3Z5	KIT-100PT3Z5	KIT-125PT3Z5	KIT-140PT3Z5	
Remote controller		CZ-RTC5B	CZ-RTC5B	CZ-RTC5B	CZ-RTC5B	CZ-RTC5B	CZ-RTC5B	CZ-RTC5B	
Cooling capacity	Nominal (Min - Max)	kW	3.5(1.5 - 4.0)	5.0(1.5 - 5.2)	6.0(2.0 - 7.1)	6.8(2.6 - 7.7)	10.0(3.0 - 11.5)	12.5(3.2 - 13.5)	14.0(3.3 - 15.0)
UK cooling	Total - Sensible	kW	3.3 - 2.4	4.8 - 3.2	5.9 - 4.0	6.5 - 4.3	10.7 - 7.1	12.6 - 8.2	13.9 - 8.9
EER ¹⁾	Nominal (Min - Max)	W/W	4.14(3.69 - 5.17)	3.03(2.86 - 5.00)	3.59(2.90 - 6.90)	3.24(2.75 - 4.91)	3.64(2.80 - 5.36)	3.32(2.77 - 5.33)	2.98(2.73 - 5.32)
SEER / η_{sc}²⁾			7.2 A++	6.7 A++	7.3 A++	5.9 A+	6.6 A++	241.7 %	228.8 %
Pdesign		kW	3.5	5.0	6.0	6.8	10.0	12.5	14.0
Input power	Nominal (Min - Max)	kW	0.85(0.29 - 1.10)	1.65(0.30 - 1.82)	1.67(0.29 - 2.45)	2.10(0.53 - 2.80)	2.75(0.56 - 4.10)	3.76(0.60 - 4.88)	4.70(0.62 - 5.50)
Annual energy consumption ³⁾		kWh/a	171	262	288	404	531	—	—
Heating capacity	Nominal (Min - Max)	kW	3.5(1.5 - 4.6)	5.0(1.5 - 6.4)	6.0(1.8 - 7.0)	6.8(2.1 - 8.1)	10.0(3.0 - 14.0)	12.5(3.3 - 15.0)	14.0(3.4 - 16.0)
UK heating	Total	kW	3.9	5.6	6.1	6.9	12.68	14.7	15.22
COP ¹⁾	Nominal (Min - Max)	W/W	4.61(3.51 - 5.70)	3.73(3.12 - 6.25)	4.11(2.92 - 6.67)	4.20(3.06 - 5.68)	4.24(3.30 - 5.36)	3.89(3.41 - 4.52)	3.70(3.08 - 5.48)
SCOP / η_{sh}²⁾			4.4 A+	4.1 A+	4.6 A++	4.3 A+	4.2 A+	147.4 %	145.3 %
Pdesign at -10 °C		kW	2.8	4.0	4.6	4.7	10.0	12.5	13.6
Input power	Nominal (Min - Max)	kW	0.76(0.26 - 1.31)	1.34(0.24 - 2.05)	1.46(0.27 - 2.40)	1.62(0.37 - 2.65)	2.36(0.56 - 4.00)	3.21(0.73 - 4.40)	3.78(0.62 - 5.20)
Annual energy consumption ³⁾		kWh/a	891	1365	1399	1529	3331	—	—
Indoor unit			S-3650PT3E	S-3650PT3E	S-6071PT3E	S-6071PT3E	S-1014PT3E	S-1014PT3E	S-1014PT3E
Air flow	Hi / Med / Lo	m ³ /sec	0.23/0.20/0.18	0.25/0.21/0.18	0.33/0.28/0.24	0.35/0.30/0.26	0.50/0.42/0.38	0.57/0.47/0.40	0.58/0.48/0.42
Moisture removal volume		L/h	0.8	2.0	2.1	2.7	4.1	5.7	6.9
Sound pressure ⁴⁾	Hi / Med / Lo	dB(A)	36/32/28	37/33/28	38/34/29	39/35/30	42/37/34	46/40/35	47/41/36
Sound power	Hi / Med / Lo	dB(A)	54/50/46	55/51/46	56/52/47	57/53/48	60/55/52	64/58/53	65/59/54
Dimension	HxWxD	mm	235x960x690	235x960x690	235x1275x690	235x1275x690	235x1590x690	235x1590x690	235x1590x690
Net weight		kg	26	26	34	34	40	40	40
nanoe X Generator			Mark 2	Mark 2	Mark 2	Mark 2	Mark 2	Mark 2	Mark 2
Outdoor unit			U-36PZ3E5	U-50PZ3E5	U-60PZ3E5A	U-71PZ3E5A	U-100PZ3E5	U-125PZ3E5	U-140PZ3E5
Power supply		V	220 - 230 - 240	220 - 230 - 240	220 - 230 - 240	220 - 230 - 240	220 - 230 - 240	220 - 230 - 240	220 - 230 - 240
Maximum fuse size		A	15	15	20	20	35	40	40
Current	Cool	A	3.90 - 3.75 - 3.60	7.65 - 7.30 - 7.00	7.75 - 7.40 - 7.10	9.75 - 9.30 - 8.95	13.70 - 13.10 - 12.60	18.20 - 17.40 - 16.70	22.70 - 21.70 - 20.80
	Heat	A	3.55 - 3.40 - 3.25	6.30 - 6.00 - 5.75	6.75 - 6.50 - 6.20	7.50 - 7.20 - 6.90	11.80 - 11.30 - 10.80	15.50 - 14.80 - 14.20	18.30 - 17.50 - 16.80
Air flow	Cool / Heat	m ³ /sec	0.56/0.57	0.55/0.53	0.71/0.69	0.75/0.77	1.22/1.22	1.37/1.33	1.40/1.37
Sound pressure	Cool / Heat (Hi)	dB(A)	46/47	46/46	47/48	48/49	52/52	55/55	56/56
Sound power	Cool / Heat (Hi)	dB(A)	64/66	64/64	64/65	66/68	70/70	73/73	74/74
Dimension	HxWxD	mm	619x824x299	619x824x299	695x875x320	695x875x320	996x980x370	996x980x370	996x980x370
Net weight		kg	32	35	42	50	83	87	87
Piping diameter	Liquid pipe	Inch (mm)	1/4(6.35)	1/4(6.35)	1/4(6.35) ⁵⁾	1/4(6.35) ⁵⁾	3/8(9.52)	3/8(9.52)	3/8(9.52)
	Gas pipe	Inch (mm)	1/2(12.70)	1/2(12.70)	1/2(12.70) ⁶⁾	5/8(15.88)	5/8(15.88)	5/8(15.88)	5/8(15.88)
Pipe length range		m	3~15	3~20	3~40	3~40	5~50	5~50	5~50
Elevation difference (in / out) ⁷⁾		m	15/15	15/15	15/30	20/30	15/30	15/30	15/30
Pipe length for additional gas		m	7.5	7.5	30	30	30	30	30
Additional gas amount		g/m	10	15	15	17	45	45	45
Refrigerant (R32) / CO ₂ Eq.		kg / T	0.87/0.59	1.14/0.77	1.15/0.78	1.32/0.89	2.40/1.62	2.80/1.89	2.80/1.89
Operating range	Cool Min - Max	°C	-10~+43	-10~+43	-10~+43	-10~+43	-10~+43	-10~+43	-10~+43
	Heat Min - Max	°C	-15~+24	-15~+24	-15~+24	-15~+24	-15~+24	-15~+24	-15~+24
Kit RRP		£	1.757	1.985	2.207	2.504	3.097	3.405	4.036
Indoor unit RRP		£	845	845	1.058	1.058	1.358	1.358	1.358
Outdoor unit RRP		£	768	996	1.005	1.302	1.595	1.903	2.534
Wired control RRP		£	144	144	144	144	144	144	144

Technical focus

- Wide air distribution for large rooms
- Horizontal air flow reaches maximum 9.5 m
- Fresh air connection available on the unit
- Slim design with 235 mm height fits narrow space
- Silent operation
- nanoe™ X (Generator Mark 2= 9.6 trillion hydroxyl radicals/sec) as standard for better indoor air quality
- Wired remote control CZ-RTC6BL allows easy system setting via Bluetooth®
- Single and twin options
- Easy connection and control of external fan or ERV using the connector PAW-FDC on the indoor unit PCB. The external device can be controlled by the remote control of the Panasonic indoor unit

Further comfort improvement with air flow distribution

Horizontal air flow reaches maximum 9.5 m. This is ideal for wide rooms.

The wide air discharge opening expands the air flow to the left and right. The unpleasant feeling caused when the air flow directly hits the human body is prevented by the "Draft prevention position", which changes the swing width, so that the degree of comfort is increased.



CZ-RTC5B



CONEX



Optional controller.
CONEX wired remote
controller.
CZ-RTC6 - CZ-RTC6BL
- CZ-RTC6BLW



Optional controller.
Infrared remote
controller.
CZ-RWS3 +
CZ-RWRT3



Optional Econavi
sensor.
CZ-CENSC1

COMPATIBLE WITH ALL PANASONIC
CONNECTIVITY SOLUTIONS. FOR
DETAILED INFORMATION GO TO THE
CONTROL SYSTEMS SECTION

Kit	10.0 kW			Three phase		
	KIT-100PT3Z8			KIT-125PT3Z8		
Remote controller	CZ-RTC5B			CZ-RTC5B		
Cooling capacity	Nominal (Min - Max)	kW	10.0 [3.0 - 11.5]	12.5 [3.2 - 13.5]	14.0 [3.3 - 15.0]	14.0 kW
UK cooling	Total - Sensible	kW	10.7 - 7.1	12.6 - 8.2	13.9 - 8.9	
EER ¹⁾	Nominal (Min - Max)	W/W	3.64 [3.50 - 5.36]	3.32 [2.77 - 5.33]	2.98 [2.73 - 5.32]	
SEER / $\eta_{s,c}$ ²⁾			6.5 A++	241.7 %	228.8 %	
Pdesign		kW	10.0	12.5	14.0	
Input power	Nominal (Min - Max)	kW	2.75 [0.56 - 4.10]	3.76 [0.60 - 4.88]	4.70 [0.62 - 5.50]	
Annual energy consumption ³⁾		kWh/a	537	—	—	
Heating capacity	Nominal (Min - Max)	kW	10.0 [3.0 - 14.0]	12.5 [3.3 - 15.0]	14.0 [3.4 - 16.0]	
UK heating	Total	kW	12.68	14.7	15.22	
COP ¹⁾	Nominal (Min - Max)	W/W	4.24 [3.50 - 5.36]	3.89 [3.41 - 4.52]	3.70 [3.08 - 5.48]	
SCOP / $\eta_{s,h}$ ²⁾			4.2 A+	147.4 %	145.3 %	
Pdesign at -10 °C		kW	10.0	12.5	13.6	
Input power	Nominal (Min - Max)	kW	2.36 [0.56 - 4.00]	3.21 [0.73 - 4.40]	3.78 [0.62 - 5.20]	
Annual energy consumption ³⁾		kWh/a	3331	—	—	
Indoor unit			S-1014PT3E	S-1014PT3E	S-1014PT3E	
Air flow	Hi / Med / Lo	m ³ /sec	0.50 / 0.42 / 0.38	0.57 / 0.47 / 0.40	0.58 / 0.48 / 0.42	
Moisture removal volume		L/h	4.1	5.7	6.9	
Sound pressure ⁴⁾	Hi / Med / Lo	dB(A)	42 / 37 / 34	46 / 40 / 35	47 / 41 / 36	
Sound power	Hi / Med / Lo	dB(A)	60 / 55 / 52	64 / 58 / 53	65 / 59 / 54	
Dimension	H x W x D	mm	235 x 1590 x 690	235 x 1590 x 690	235 x 1590 x 690	
Net weight		kg	40	40	40	
nanoe X Generator			Mark 2	Mark 2	Mark 2	
Outdoor unit			U-100PZ3E8	U-125PZ3E8	U-140PZ3E8	
Power supply		V	380 - 400 - 415	380 - 400 - 415	380 - 400 - 415	
Maximum fuse size		A	15	20	20	
Current	Cool	A	4.60 - 4.35 - 4.20	6.10 - 5.75 - 5.55	7.60 - 7.20 - 6.95	
	Heat	A	3.95 - 3.75 - 3.60	5.20 - 4.95 - 4.75	6.10 - 5.80 - 5.60	
Air flow	Cool / Heat	m ³ /sec	1.22 / 1.22	1.37 / 1.33	1.40 / 1.37	
Sound pressure	Cool / Heat (Hi)	dB(A)	52 / 52	55 / 55	56 / 56	
Sound power	Cool / Heat (Hi)	dB(A)	70 / 70	73 / 73	74 / 74	
Dimension	H x W x D	mm	996 x 980 x 370	996 x 980 x 370	996 x 980 x 370	
Net weight		kg	83	87	87	
Piping diameter	Liquid pipe	Inch (mm)	3/8 (9.52)	3/8 (9.52)	3/8 (9.52)	
	Gas pipe	Inch (mm)	5/8 (15.88)	5/8 (15.88)	5/8 (15.88)	
Pipe length range		m	5 - 50	5 - 50	5 - 50	
Elevation difference (in / out) ⁷⁾		m	15 / 30	15 / 30	15 / 30	
Pipe length for additional gas		m	30	30	30	
Additional gas amount		g/m	45	45	45	
Refrigerant (R32) / CO ₂ Eq.		kg / T	2.40 / 1.62	2.8 / 1.89	2.8 / 1.89	
Operating range	Cool Min ~ Max	°C	-10 ~ +43	-10 ~ +43	-10 ~ +43	
	Heat Min ~ Max	°C	-15 ~ +24	-15 ~ +24	-15 ~ +24	
Kit RRP		£	3.195	3.465	4.066	
Indoor unit RRP		£	1.358	1.358	1.358	
Outdoor unit RRP		£	1.693	1.963	2.564	
Wired control RRP		£	144	144	144	

1) EER and COP calculation is based in accordance to EN14511. 2) For models below 12 kW, the SEER and SCOP is calculated based on values of EU/626/2011. For models above 12 kW, the $\eta_{s,c}$ / $\eta_{s,h}$ values is calculated based on EN 14825. 3) Factory setting. 4) The sound pressure of the units shows the value measured of the position 1 m in front of the main body and 1 m below the unit. The sound pressure is measured in accordance with Eurovent 6/C/006-97 specification. 5) Connect the liquid socket tube (Ø6.35-Ø9.52) to the liquid tubing side indoor unit. 6) Connect the gas socket tube (Ø12.70-Ø15.88) to the gas tubing side indoor unit. 7) Outdoor unit located lower / outdoor unit located higher. * Recommended fuse for the indoor 3 A. ** Above values are in the case of nanoe™ X OFF.

Accessories		RRP £
CZ-RTC6L	CONEX wired remote controller (non-wireless)	144
CZ-RTC6BL	CONEX wired remote controller with Bluetooth®	172
CZ-RTC6BLW	CONEX wired remote controller with Wi-Fi and Bluetooth®	242
CZ-RTC5B	Wired remote controller with Econavi function and datanavi	144
CZ-RWS3 + CZ-RWRT3	Infrared remote controller and receiver	276

Accessories		RRP £
CZ-CAPWFC1	Commercial Wi-Fi Adaptor	176
PAW-PACR3	Interfaces to run 3 units on back-up and alternative run	1.745
PAW-WTRAY	Tray for condenser water compatible with outdoor elevation platform	133
PAW-GRDBSE20	Outdoor base ground support for noise and vibration absorption	122
PAW-GRDSTD40	Outdoor elevation platform 400x900x400 mm	133
CZ-CENSC1	Econavi energy savings sensor	151



SEER and SCOP: For S-6071PT3E + U-60PZ3E5A. INTERNET CONTROL: Optional.

Rating Conditions: Cooling Indoor 27 °C DB / 19 °C WB. Cooling Outdoor 35 °C DB / 24 °C WB. Heating Indoor 20 °C DB. Heating Outdoor 7 °C DB / 6 °C WB. (DB: Dry Bulb; WB: Wet Bulb). Specifications subject to change without notice. For detailed information about ErP / Energy Labelling, please visit our websites www.panasonic.co.uk/aircon or www.ptc.panasonic.eu.



nanoe™ X as a standard.



PACi NX Series Elite ceiling Inverter+ · R32

Ceiling mounted units provide large and wide air distribution which is good for big rooms.

The height and depth of all capacities are the same for unified appearance in mixed installations.

		Single phase							
		3.6 kW	5.0 kW	6.0 kW	7.1 kW	10.0 kW	12.5 kW	14.0 kW	
Kit		KIT-36PT3ZH5	KIT-50PT3ZH5	KIT-60PT3ZH5	KIT-71PT3ZH5	KIT-100PT3ZH5	KIT-125PT3ZH5	KIT-140PT3ZH5	
Remote controller		CZ-RTC5B	CZ-RTC5B	CZ-RTC5B	CZ-RTC5B	CZ-RTC5B	CZ-RTC5B	CZ-RTC5B	
Cooling capacity	Nominal (Min - Max)	kW	3.5(1.2 - 4.0)	5.0(1.2 - 5.6)	6.0(1.2 - 7.1)	6.8(2.2 - 9.0)	9.5(3.1 - 12.5)	12.1(3.2 - 14.0)	13.4(3.3 - 16.0)
UK cooling	Total - Sensible	kW	3.4 - 2.5	4.9 - 3.3	5.9 - 4.0	8.1 - 5.2	11.4 - 7.5	12.8 - 8.3	14.6 - 9.2
EER ¹⁾	Nominal (Min - Max)	W/W	4.86(4.55 - 5.45)	4.03(3.57 - 5.45)	3.82(3.02 - 5.45)	3.91(2.69 - 5.79)	4.15(3.29 - 5.54)	3.51(3.01 - 5.33)	3.21(2.67 - 5.32)
SEER / η _{sc} ²⁾			7.7 A++	7.4 A++	7.5 A++	7.3 A++	7.3 A++	278.4 %	263.3 %
Pdesign		kW	3.5	5.0	6.0	6.8	9.5	12.1	13.4
Input power	Nominal (Min - Max)	kW	0.72(0.22 - 0.88)	1.24(0.22 - 1.57)	1.57(0.22 - 2.35)	1.74(0.38 - 3.35)	2.29(0.58 - 3.80)	3.45(0.60 - 4.65)	4.17(0.62 - 6.00)
Annual energy consumption ³⁾		kWh/a	160	237	280	326	456	—	—
Heating capacity	Nominal (Min - Max)	kW	4.0(1.2 - 5.0)	5.6(1.2 - 6.5)	7.0(1.2 - 8.0)	8.0(2.0 - 9.0)	11.2(3.1 - 14.0)	14.0(3.2 - 16.0)	16.0(3.3 - 18.0)
UK heating	Total	kW	4.34	5.6	6.92	8.55	12.65	14.5	16.35
COP ¹⁾	Nominal (Min - Max)	W/W	5.00(4.17 - 5.45)	4.03(3.94 - 5.45)	4.14(3.40 - 5.45)	3.96(3.16 - 5.56)	4.09(3.54 - 5.54)	3.78(3.20 - 5.52)	3.48(3.10 - 5.50)
SCOP / η _{sh} ²⁾			4.9 A++	4.8 A++	4.8 A++	4.7 A++	4.7 A++	181.0 %	178.0 %
Pdesign at -10 °C		kW	3.1	4.0	4.6	4.7	7.8	9.5	10.2
Input power	Nominal (Min - Max)	kW	0.80(0.22 - 1.20)	1.39(0.22 - 1.65)	1.69(0.22 - 2.35)	2.02(0.36 - 2.85)	2.74(0.56 - 3.95)	3.70(0.58 - 5.00)	4.60(0.60 - 5.80)
Annual energy consumption ³⁾		kWh/a	886	1167	1342	1400	2323	—	—
Indoor unit			S-3650PT3E	S-3650PT3E	S-6071PT3E	S-6071PT3E	S-1014PT3E	S-1014PT3E	S-1014PT3E
Air flow	Hi / Med / Lo	m ³ /sec	0.23/0.20/0.18	0.25/0.21/0.18	0.33/0.28/0.24	0.35/0.30/0.26	0.50/0.42/0.38	0.57/0.47/0.40	0.58/0.48/0.42
Moisture removal volume		L/h	0.8	2.0	2.1	2.7	3.6	5.4	6.4
Sound pressure ⁴⁾	Hi / Med / Lo	dB(A)	36/32/28	37/33/28	38/34/29	39/35/30	42/37/34	46/40/35	47/41/36
Sound power	Hi / Med / Lo	dB(A)	54/50/46	55/51/46	56/52/47	57/53/48	60/55/52	64/58/53	65/59/54
Dimension	HxWxD	mm	235x960x690	235x960x690	235x1275x690	235x1275x690	235x1590x690	235x1590x690	235x1590x690
Net weight		kg	26	26	34	34	40	40	40
nanoe X Generator			Mark 2	Mark 2	Mark 2	Mark 2	Mark 2	Mark 2	Mark 2
Outdoor unit			U-36PZH3E5	U-50PZH3E5	U-60PZH3E5	U-71PZH3E5	U-100PZH3E5	U-125PZH3E5	U-140PZH3E5
Power supply		V	220 - 230 - 240	220 - 230 - 240	220 - 230 - 240	220 - 230 - 240	220 - 230 - 240	220 - 230 - 240	220 - 230 - 240
Maximum fuse size		A	20	20	25	25	35	40	40
Current	Cool	A	3.55 - 3.40 - 3.25	5.85 - 5.60 - 5.40	7.35 - 7.05 - 6.75	8.60 - 8.20 - 7.90	11.30 - 10.80 - 10.40	16.90 - 16.10 - 15.50	20.40 - 19.50 - 18.70
	Heat	A	3.90 - 3.75 - 3.60	6.60 - 6.30 - 6.05	7.85 - 7.50 - 7.20	9.75 - 9.45 - 9.05	13.40 - 12.90 - 12.40	18.10 - 17.30 - 16.60	22.50 - 21.50 - 20.60
Air flow	Cool / Heat	m ³ /sec	0.57/0.61	0.70/0.70	0.70/0.70	1.02/1.00	1.97/1.80	2.08/1.87	2.15/1.93
Sound pressure	Cool / Heat (Hi)	dB(A)	43/44	46/48	47/50	48/50	52/52	53/53	54/54
Sound power	Cool / Heat (Hi)	dB(A)	62/64	64/67	65/69	65/67	69/69	70/70	71/71
Dimension	HxWxD	mm	695x875x320	695x875x320	695x875x320	996x940x340	1416x940x340	1416x940x340	1416x940x340
Net weight		kg	42	42	43	65	98	98	98
Piping diameter	Liquid pipe	Inch (mm)	1/4(6.35)	1/4(6.35)	1/4(6.35) ⁵⁾	3/8(9.52)	3/8(9.52)	3/8(9.52)	3/8(9.52)
	Gas pipe	Inch (mm)	1/2(12.70)	1/2(12.70)	1/2(12.70) ⁶⁾	5/8(15.88)	5/8(15.88)	5/8(15.88)	5/8(15.88)
Pipe length range		m	3 - 40	3 - 40	3 - 40	5 - 50	5 - 85	5 - 85	5 - 85
Elevation difference (in / out) ⁷⁾		m	15/30	15/30	15/30	15/30	15/30	15/30	15/30
Pipe length for additional gas		m	30	30	30	30	30	30	30
Additional gas amount		g/m	15	15	15	45	45	45	45
Refrigerant (R32) / CO ₂ Eq.		kg / T	1.13/0.76	1.13/0.76	1.15/0.78	1.95/1.32	3.05/2.06	3.05/2.06	3.05/2.06
Operating range	Cool Min - Max	°C	-15 ~ +46	-15 ~ +46	-15 ~ +46	-15 ~ +48	-20 ~ +48 ⁸⁾	-20 ~ +48 ⁸⁾	-20 ~ +48 ⁸⁾
	Heat Min - Max	°C	-20 ~ +24	-20 ~ +24	-20 ~ +24	-20 ~ +24	-20 ~ +24	-20 ~ +24	-20 ~ +24
Kit RRP		£	2.101	2.293	2.649	3.043	3.825	4.099	4.539
Indoor unit RRP		£	845	845	1.058	1.058	1.358	1.358	1.358
Outdoor unit RRP		£	1.112	1.304	1.447	1.841	2.323	2.597	3.037
Wired control RRP		£	144	144	144	144	144	144	144

Technical focus

- Wide air distribution for large rooms
- Horizontal air flow reaches maximum 9.5 m
- Fresh air connection available on the unit
- Slim design with 235 mm height fits narrow space
- Silent operation
- nanoe™ X (Generator Mark 2= 9.6 trillion hydroxyl radicals/sec) as standard for better indoor air quality
- Wired remote control CZ-RTC6BL allows easy system setting via Bluetooth®
- Twin, Triple and Double-twin split options
- Easy connection and control of external fan or ERV using the connector PAW-FDC on the indoor unit PCB. The external device can be controlled by the remote control of the Panasonic indoor unit

Further comfort improvement with air flow distribution

Horizontal air flow reaches maximum 9.5 m. This is ideal for wide rooms.

The wide air discharge opening expands the air flow to the left and right. The unpleasant feeling caused when the air flow directly hits the human body is prevented by the "Draft prevention position", which changes the swing width, so that the degree of comfort is increased.



CZ-RTC5B



Optional controller.
CONEX wired remote controller.
CZ-RTC6 - CZ-RTC6BL
- CZ-RTC6BLW



Optional controller.
Infrared remote controller.
CZ-RWS3 + CZ-RWRT3



Optional Econavi sensor.
CZ-CENSC1

COMPATIBLE WITH ALL PANASONIC CONNECTIVITY SOLUTIONS. FOR DETAILED INFORMATION GO TO THE CONTROL SYSTEMS SECTION

Three phase

			7.1 kW	10.0 kW	12.5 kW	14.0 kW
Kit			KIT-71PT3ZH8	KIT-100PT3ZH8	KIT-125PT3ZH8	KIT-140PT3ZH8
Remote controller			CZ-RTC5B	CZ-RTC5B	CZ-RTC5B	CZ-RTC5B
Cooling capacity	Nominal (Min - Max)	kW	6.8 [2.2 - 9.0]	9.5 [3.1 - 12.5]	12.1 [3.2 - 14.0]	13.4 [3.3 - 16.0]
UK cooling	Total - Sensible	kW	8.1 - 5.2	11.4 - 7.5	12.8 - 8.3	14.6 - 9.2
EER ¹⁾	Nominal (Min - Max)	W/W	3.91 [2.69 - 5.79]	4.15 [3.29 - 5.34]	3.51 [3.01 - 5.33]	3.21 [2.67 - 5.32]
SEER / η _{sc} ²⁾			7.2 A++	7.2 A++	277.3 %	262.4 %
P _{design}		kW	6.8	9.5	12.1	13.4
Input power	Nominal (Min - Max)	kW	1.74 [0.38 - 3.35]	2.29 [0.58 - 3.80]	3.45 [0.60 - 4.65]	4.17 [0.62 - 6.00]
Annual energy consumption ³⁾		kWh/a	331	462	—	—
Heating capacity	Nominal (Min - Max)	kW	8.0 [2.0 - 9.0]	11.2 [3.1 - 14.0]	14.0 [3.2 - 16.0]	16.0 [3.3 - 18.0]
UK heating	Total	kW	8.55	12.65	14.5	16.35
COP ¹⁾	Nominal (Min - Max)	W/W	3.96 [3.16 - 5.56]	4.09 [3.54 - 5.54]	3.78 [3.20 - 5.52]	3.48 [3.10 - 5.50]
SCOP / η _{sh} ²⁾			4.7 A++	4.7 A++	180.9 %	178.0 %
P _{design} at -10 °C		kW	4.7	7.8	9.5	10.2
Input power	Nominal (Min - Max)	kW	2.02 [0.36 - 2.85]	2.74 [0.56 - 3.95]	3.70 [0.58 - 5.00]	4.60 [0.60 - 5.80]
Annual energy consumption ³⁾		kWh/a	1400	2324	—	—
Indoor unit			S-6071PT3E	S-1014PT3E	S-1014PT3E	S-1014PT3E
Air flow	Hi / Med / Lo	m ³ /sec	0.35/0.30/0.26	0.50/0.42/0.38	0.57/0.47/0.40	0.58/0.48/0.42
Moisture removal volume		L/h	2.7	3.6	5.4	6.4
Sound pressure ⁴⁾	Hi / Med / Lo	dB(A)	39/35/30	42/37/34	46/40/35	47/41/36
Sound power	Hi / Med / Lo	dB(A)	57/53/48	60/55/52	64/58/53	65/59/54
Dimension	H x W x D	mm	235 x 1275 x 690	235 x 1590 x 690	235 x 1590 x 690	235 x 1590 x 690
Net weight		kg	34	40	40	40
nanoe X Generator			Mark 2	Mark 2	Mark 2	Mark 2
Outdoor unit			U-71PZH3E8	U-100PZH3E8	U-125PZH3E8	U-140PZH3E8
Power supply		V	380 - 400 - 415	380 - 400 - 415	380 - 400 - 415	380 - 400 - 415
Maximum fuse size		A	15	15	15	15
Current	Cool	A	2.90 - 2.80 - 2.70	3.80 - 3.65 - 3.45	5.70 - 5.40 - 5.20	6.90 - 6.55 - 6.30
	Heat	A	3.35 - 3.20 - 3.10	4.55 - 4.35 - 4.15	6.20 - 5.85 - 5.65	7.70 - 7.30 - 6.95
Air flow	Cool / Heat	m ³ /sec	1.02/1.00	1.97/1.80	2.08/1.87	2.15/1.93
Sound pressure	Cool / Heat (Hi)	dB(A)	48/50	52/52	53/53	54/54
Sound power	Cool / Heat (Hi)	dB(A)	65/67	69/69	70/70	71/71
Dimension	H x W x D	mm	996 x 940 x 340	1416 x 940 x 340	1416 x 940 x 340	1416 x 940 x 340
Net weight		kg	65	98	98	98
Piping diameter	Liquid pipe	Inch (mm)	3/8 (9.52)	3/8 (9.52)	3/8 (9.52)	3/8 (9.52)
	Gas pipe	Inch (mm)	5/8 (15.88)	5/8 (15.88)	5/8 (15.88)	5/8 (15.88)
Pipe length range		m	5 - 50	5 - 85	5 - 85	5 - 85
Elevation difference (in / out) ⁷⁾		m	15/30 ⁸⁾	15/30	15/30	15/30
Pipe length for additional gas		m	30	30	30	30
Additional gas amount		g/m	45	45	45	45
Refrigerant (R32) / CO ₂ Eq.		kg / T	1.95/1.32	3.05/2.06	3.05/2.06	3.05/2.06
Operating range	Cool Min ~ Max	°C	-15 ~ +48	-20 ~ +48 ⁸⁾	-20 ~ +48 ⁸⁾	-20 ~ +48 ⁸⁾
	Heat Min ~ Max	°C	-20 ~ +24	-20 ~ +24	-20 ~ +24	-20 ~ +24
Kit RRP		£	3.096	3.862	4.215	4.858
Indoor unit RRP		£	1.058	1.358	1.358	1.358
Outdoor unit RRP		£	1.894	2.360	2.713	3.356
Wired control RRP		£	144	144	144	144

1) EER and COP calculation is based in accordance to EN14511. 2) For models below 12 kW, the SEER and SCOP is calculated based on values of EU/626/2011. For models above 12 kW, the η_{sc} / η_{sh} values is calculated based on EN 14825. 3) Factory setting. 4) The sound pressure of the units shows the value measured of the position 1 m in front of the main body and 1 m below the unit. The sound pressure is measured in accordance with Eurovent 6/C/006-97 specification. 5) Connect the liquid socket tube (Ø6.35-Ø9.52) to the liquid tubing side indoor unit. 6) Connect the gas socket tube (Ø12.70-Ø15.88) to the gas tubing side indoor unit. 7) Outdoor unit located lower / outdoor unit located higher. 8) For models 100 ~ 140PZH3E5(8), it is possible to operate the lowest -20 °C in the computer rooms with the piping length of 30 m or less. * Recommended fuse for the indoor 3 A. ** Above values are in the case of nanoe™ X OFF.

Accessories		RRP £
CZ-RTC6	CONEX wired remote controller (non-wireless)	144
CZ-RTC6BL	CONEX wired remote controller with Bluetooth®	172
CZ-RTC6BLW	CONEX wired remote controller with Wi-Fi and Bluetooth®	242
CZ-RTC5B	Wired remote controller with Econavi function and datanavi	144
CZ-RWS3 + CZ-RWRT3	Infrared remote controller and receiver	276

Accessories		RRP £
CZ-CAPWFC1	Commercial Wi-Fi Adaptor	176
PAW-PACR3	Interfaces to run 3 units on back-up and alternative run	1.745
PAW-WTRAY	Tray for condenser water compatible with outdoor elevation platform	133
PAW-GRDBSE20	Outdoor base ground support for noise and vibration absorption	122
PAW-GRDSTD40	Outdoor elevation platform 400x900x400 mm	133
CZ-CENSC1	Econavi energy savings sensor	151



SEER and SCOP: For S-3650PT3E + U-36PZH3E5. INTERNET CONTROL: Optional.

Rating Conditions: Cooling Indoor 27 °C DB / 19 °C WB. Cooling Outdoor 35 °C DB / 24 °C WB. Heating Indoor 20 °C DB. Heating Outdoor 7 °C DB / 6 °C WB. (DB: Dry Bulb; WB: Wet Bulb). Specifications subject to change without notice. For detailed information about ErP / Energy Labelling, please visit our websites www.panasonic.co.uk/aircon or www.ptc.panasonic.eu.



nanoe™ X
nanoe™ X as a standard.

PACi NX Series Standard adaptive ducted unit Inverter+ R32

Adaptive ducted unit - PF3.

2 installation possibilities (horizontal / vertical) with high ESP 150 Pa allows for flexible installation.

		Single phase							
		3.6 kW	5.0 kW	6.0 kW	7.1 kW	10.0 kW	12.5 kW	14.0 kW	
Kit		KIT-36PF3Z5	KIT-50PF3Z5	KIT-60PF3Z5	KIT-71PF3Z5	KIT-100PF3Z5	KIT-125PF3Z5	KIT-140PF3Z5	
Remote controller		CZ-RTC5B	CZ-RTC5B	CZ-RTC5B	CZ-RTC5B	CZ-RTC5B	CZ-RTC5B	CZ-RTC5B	
Cooling capacity	Nominal (Min - Max)	kW	3.4(1.5-4.0)	5.0(1.5-5.3)	5.7(2.0-6.3)	6.8(2.6-7.7)	9.5(3.0-11.4)	12.1(3.2-13.5)	13.4(3.3-15.0)
UK cooling	Total - Sensible	kW	3.2 - 2.3	4.8 - 3.1	5.6 - 3.7	6.5 - 4.2	10.6 - 7.3	12.6 - 8.2	13.9 - 9
EER ¹⁾	Nominal (Min - Max)	W/W	3.78(3.51-5.00)	2.78(2.76-4.63)	3.54(2.63-5.88)	3.18(2.69-4.56)	3.57(2.36-5.08)	3.40(2.76-5.08)	3.16(2.56-5.08)
SEER / η _{sc} ²⁾			6.0 A+	6.5 A++	6.4 A++	6.0 A+	6.6 A++	257.4 %	252.2 %
Pdesign		kW	3.4	5.0	5.7	6.8	9.5	12.1	13.4
Input power	Nominal (Min - Max)	kW	0.90(0.30-1.14)	1.80(0.32-1.92)	1.61(0.34-2.40)	2.14(0.57-2.86)	2.66(0.59-4.84)	3.56(0.63-4.90)	4.24(0.65-5.86)
Annual energy consumption ³⁾		kWh/a	198	267	310	391	502	—	—
Heating capacity	Nominal (Min - Max)	kW	3.4(1.5-4.6)	5.0(1.5-5.9)	5.7(1.8-7.0)	6.8(2.1-8.1)	9.5(3.0-13.5)	12.1(3.3-15.0)	13.4(3.4-16.0)
UK heating	Total	kW	3.9	5.2	6.2	6.9	12.18	14.7	15.22
COP ¹⁾	Nominal (Min - Max)	W/W	4.15(3.51-5.36)	3.62(3.06-5.36)	4.04(2.82-6.21)	4.00(3.03-5.68)	4.09(3.00-5.08)	3.56(3.16-5.24)	3.76(3.03-5.23)
SCOP / η _{sh} ²⁾			4.0 A+	4.0 A+	4.4 A+	4.1 A+	3.9 A	142.6 %	140.6 %
Pdesign at -10 °C		kW	2.4	3.8	4.4	4.7	7.8	9.3	9.5
Input power	Nominal (Min - Max)	kW	0.82(0.28-1.31)	1.38(0.28-1.73)	1.41(0.29-2.48)	1.70(0.37-2.67)	2.32(0.59-4.50)	3.40(0.63-4.74)	3.56(0.65-5.28)
Annual energy consumption ³⁾		kWh/a	839	1303	1376	1591	2795	—	—
Indoor unit			S-3650PF3E	S-3650PF3E	S-6071PF3E	S-6071PF3E	S-1014PF3E	S-1014PF3E	S-1014PF3E
External static pressure ⁴⁾	Nominal (Min - Max)	Pa	30(10-150)	30(10-150)	30(10-150)	30(10-150)	40(10-150)	50(10-150)	50(10-150)
Air flow	Hi / Med / Lo	m ³ /sec	0.23/0.22/0.17	0.27/0.25/0.20	0.35/0.32/0.25	0.35/0.32/0.25	0.53/0.43/0.35	0.57/0.48/0.38	0.60/0.53/0.42
Moisture removal volume		L/h	0.9	1.9	1.7	2.7	3.2	4.1	4.9
Sound pressure ⁵⁾	Hi / Med / Lo	dB(A)	30/27/22	34/30/25	30/26/23	30/26/23	33/29/25	35/31/27	39/35/29
Sound power	Hi / Med / Lo	dB(A)	53/50/45	57/53/48	53/49/46	53/49/46	56/52/48	58/54/50	62/58/52
Dimension	HxWxD	mm	250x800x730	250x800x730	250x1000x730	250x1000x730	250x1400x730	250x1400x730	250x1400x730
Net weight		kg	25	25	30	30	39	39	39
nanoe X Generator			Mark 2	Mark 2	Mark 2	Mark 2	Mark 2	Mark 2	Mark 2
Outdoor unit			U-36PZ3E5	U-50PZ3E5	U-60PZ3E5A	U-71PZ3E5A	U-100PZ3E5	U-125PZ3E5	U-140PZ3E5
Power supply	V		220-230-240	220-230-240	220-230-240	220-230-240	220-230-240	220-230-240	220-230-240
Maximum fuse size	A		15	15	20	20	35	40	40
Current	Cool	A	4.15-4.00-3.85	8.35-8.00-7.65	7.45-7.15-6.85	9.95-9.50-9.10	13.30-12.70-12.20	17.20-16.40-15.80	20.50-19.60-18.8
	Heat	A	3.85-3.70-3.50	6.45-6.20-5.95	6.55-6.25-6.00	7.90-7.55-7.25	11.60-11.10-10.60	16.40-15.70-15.00	17.20-16.40-15.80
Air flow	Cool / Heat	m ³ /sec	0.56/0.57	0.55/0.53	0.71/0.69	0.75/0.77	1.22/1.22	1.37/1.33	1.40/1.37
Sound pressure	Cool / Heat (Hi)	dB(A)	46/47	46/46	47/48	48/49	52/52	55/55	56/56
Sound power	Cool / Heat (Hi)	dB(A)	64/66	64/64	64/65	66/68	70/70	73/73	74/74
Dimension	HxWxD	mm	619x824x299	619x824x299	695x875x320	695x875x320	996x980x370	996x980x370	996x980x370
Net weight		kg	32	35	42	50	83	87	87
Piping diameter	Liquid pipe	Inch (mm)	1/4(Ø6.35)	1/4(Ø6.35)	1/4(Ø6.35) ⁶⁾	1/4(Ø6.35) ⁶⁾	3/8(9.52)	3/8(9.52)	3/8(9.52)
	Gas pipe	Inch (mm)	1/2(Ø12.7)	1/2(Ø12.7)	1/2(Ø12.7) ⁷⁾	5/8(Ø15.88)	5/8(15.88)	5/8(15.88)	5/8(15.88)
Pipe length range		m	3-15	3-20	3-40	3-40	5-50	5-50	5-50
Elevation difference (in / out) ⁸⁾		m	15/15	15/15	15/30	20/30	15/30	15/30	15/30
Pipe length for additional gas		m	7.5	7.5	30	30	30	30	30
Additional gas amount		g/m	10	15	15	17	45	45	45
Refrigerant (R32) / CO ₂ Eq.	kg / T		0.87/0.59	1.14/0.77	1.15/0.78	1.32/0.89	2.40/1.62	2.80/1.89	2.80/1.89
Operating range	Cool Min - Max	°C	-10~+43	-10~+43	-10~+43	-10~+43	-10~+43	-10~+43	-10~+43
	Heat Min - Max	°C	-15~+24	-15~+24	-15~+24	-15~+24	-15~+24	-15~+24	-15~+24
Kit RRP		£	1.767	1.995	2.211	2.508	3.101	3.409	4.040
Indoor unit RRP		£	855	855	1.062	1.062	1.362	1.362	1.362
Outdoor unit RRP		£	768	996	1.005	1.302	1.595	1.903	2.534
Wired control RRP		£	144	144	144	144	144	144	144

Technical focus

- 2 installation possibilities (horizontal / vertical)
- Maximum external static pressure: 150 Pa
- Selectable inlet air position (rear / bottom entry)
- Improved drain pan suitable for both horizontal / vertical installation
- Drain pump included
- nanoe™ X (Generator Mark 2= 9.6 trillion hydroxyl radicals/sec) as standard for the long duct piping case*
- Wired remote control CZ-RTC6BL allows easy system setting via Bluetooth®

* The performance of nanoe™ X air can be expected even by 10 m long duct by Panasonic internal survey.

2 installation possibilities (horizontal / vertical)

Vertical installation is newly available. ESP 150 Pa, sufficient for remotely installing units away from the rooms.



Improved drain pan design

Drain pan is shared in both cases horizontal and vertical installation. No need to modify the unit.

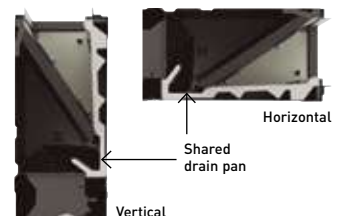

COMPATIBLE WITH ALL PANASONIC CONNECTIVITY SOLUTIONS. FOR DETAILED INFORMATION GO TO THE CONTROL SYSTEMS SECTION



CZ-RTC5B



CONEX



Optional controller.
CONEX wired remote controller.
CZ-RTC6 - CZ-RTC6BL
- CZ-RTC6BLW



Optional controller.
Infrared remote controller.
CZ-RWS3 +
CZ-RWRC3



Optional Econavi sensor.
CZ-CENSC1

Kit	10.0 kW			Three phase		
	KIT-100PF3Z8			KIT-125PF3Z8		
Remote controller	CZ-RTC5B			CZ-RTC5B		
Cooling capacity	Nominal (Min - Max)	kW	9.5(3.0 - 11.4)	12.1(3.2 - 13.5)	13.4(3.3 - 15.0)	
UK cooling	Total - Sensible	kW	10.6 - 7.3	12.6 - 8.2	13.9 - 9	
EER ¹⁾	Nominal (Min - Max)	W/W	3.57(2.36 - 5.08)	3.40(2.76 - 5.08)	3.16(2.56 - 5.08)	
SEER / $\eta_{sc}^{2)}$			6.5 A++	256.2 %	251.4 %	
Pdesign		kW	9.5	12.1	13.4	
Input power	Nominal (Min - Max)	kW	2.66(0.59 - 4.84)	3.56(0.63 - 4.90)	4.24(0.65 - 5.86)	
Annual energy consumption ³⁾		kWh/a	508	—	—	
Heating capacity	Nominal (Min - Max)	kW	9.5(3.0 - 13.5)	12.1(3.3 - 15.0)	13.4(3.4 - 16.0)	
UK heating	Total	kW	12.18	14.7	15.22	
COP ¹⁾	Nominal (Min - Max)	W/W	4.09(3.00 - 5.08)	3.56(3.16 - 5.24)	3.76(3.03 - 5.23)	
SCOP / $\eta_{sh}^{2)}$			3.9 A	142.6 %	140.6 %	
Pdesign at -10 °C		kW	7.8	9.3	9.5	
Input power	Nominal (Min - Max)	kW	2.32(0.59 - 4.50)	3.40(0.63 - 4.74)	3.56(0.65 - 5.28)	
Annual energy consumption ³⁾		kWh/a	2795	—	—	
Indoor unit	S-1014PF3E			S-1014PF3E		
External static pressure ⁴⁾	Nominal (Min - Max)	Pa	40(10 - 150)	50(10 - 150)	50(10 - 150)	
Air flow	Hi / Med / Lo	m ³ /sec	0.53/0.43/0.35	0.57/0.48/0.38	0.60/0.53/0.42	
Moisture removal volume		L/h	3.2	4.1	4.9	
Sound pressure ⁵⁾	Hi / Med / Lo	dB(A)	33/29/25	35/31/27	39/35/29	
Sound power	Hi / Med / Lo	dB(A)	56/52/48	58/54/50	62/58/52	
Dimension	HxWxD	mm	250 x 1400 x 730	250 x 1400 x 730	250 x 1400 x 730	
Net weight		kg	39	39	39	
nanoe X Generator			Mark 2	Mark 2	Mark 2	
Outdoor unit	U-100PZ3E8			U-125PZ3E8		
Power supply		V	380 - 400 - 415	380 - 400 - 415	380 - 400 - 415	
Maximum fuse size		A	15	20	20	
Current	Cool	A	4.45 - 4.20 - 4.05	5.75 - 5.45 - 5.25	6.85 - 6.50 - 6.30	
	Heat	A	3.85 - 3.70 - 3.55	5.50 - 5.20 - 5.05	5.75 - 5.45 - 5.25	
Air flow	Cool / Heat	m ³ /sec	1.22/1.22	1.37/1.33	1.40/1.37	
Sound pressure	Cool / Heat (Hi)	dB(A)	52/52	55/55	56/56	
Sound power	Cool / Heat (Hi)	dB(A)	70/70	73/73	74/74	
Dimension	HxWxD	mm	996 x 980 x 370	996 x 980 x 370	996 x 980 x 370	
Net weight		kg	83	87	87	
Piping diameter	Liquid pipe	Inch (mm)	3/8(9.52)	3/8(9.52)	3/8(9.52)	
	Gas pipe	Inch (mm)	5/8(15.88)	5/8(15.88)	5/8(15.88)	
Pipe length range		m	5 - 50	5 - 50	5 - 50	
Elevation difference (in / out) ⁶⁾		m	15/30	15/30	15/30	
Pipe length for additional gas		m	30	30	30	
Additional gas amount		g/m	45	45	45	
Refrigerant (R32) / CO ₂ Eq.		kg / T	2.40/1.62	2.80/1.89	2.80/1.89	
Operating range	Cool Min ~ Max	°C	-10 ~ +43	-10 ~ +43	-10 ~ +43	
	Heat Min ~ Max	°C	-15 ~ +24	-15 ~ +24	-15 ~ +24	
Kit RRP		£	3,199	3,469	4,070	
Indoor unit RRP		£	1,362	1,362	1,362	
Outdoor unit RRP		£	1,693	1,963	2,564	
Wired control RRP		£	144	144	144	

1) EER and COP calculation is based in accordance to EN14511. 2) For models below 12 kW, the SEER and SCOP is calculated based on values of EU/626/2011. For models above 12 kW, the η_{sc} / η_{sh} values is calculated based on EN 14825. 3) Factory setting. 4) Medium external static pressure setting from factory. 5) The sound pressure of the units shows the value measured of the position 1.5 m below the unit. The sound pressure is measured in accordance with Eurovent 6/C/006-97 specification. 6) Connect the liquid socket tube (Ø6.35-Ø9.52) to the liquid tubing side indoor unit. 7) Connect the gas socket tube (Ø12.70-Ø15.88) to the gas tubing side indoor unit. 8) Outdoor unit located lower / outdoor unit located higher. * Recommended fuse for the indoor 3 A. ** Above values are in the case of standard installation(horizontal installation in the ceiling, rear side air intake) and nanoe™ X OFF.

Accessories	RRP £
CZ-RTC6 CONEX wired remote controller (non-wireless)	144
CZ-RTC6BL CONEX wired remote controller with Bluetooth®	172
CZ-RTC6BLW CONEX wired remote controller with Wi-Fi and Bluetooth®	242
CZ-RTC5B Wired remote controller with Econavi function and datanavi	144
CZ-RWS3 + CZ-RWRC3 Infrared remote controller and receiver	276
CZ-CAPWFC1 Commercial Wi-Fi Adaptor	176
PAW-PACR3 Interfaces to run 3 units on back-up and alternative run	1,745

Accessories	RRP £
PAW-WTRAY Tray for condenser water compatible with outdoor elevation platform	133
PAW-GRDBSE20 Outdoor base ground support for noise and vibration absorption	122
PAW-GRDSTD40 Outdoor elevation platform 400 x 900 x 400 mm	133
CZ-CENSC1 Econavi energy savings sensor	151
CZ-56DAF2 Air outlet plenum for S-3650PF3E	172
CZ-90DAF2 Air outlet plenum for S-6071PF3E	211
CZ-160DAF2 Air outlet plenum for S-1014PF3E	242



SEER: For S-1014PF3E + U-100PZ3E5. SCOP: For S-6071PF3E + U-60PZ3E5A. SUPER QUIET: For S-3650PF3E + U-36PZ3E5. INTERNET CONTROL: Optional.

Rating Conditions: Cooling Indoor 27 °C DB / 19 °C WB. Cooling Outdoor 35 °C DB / 24 °C WB. Heating Indoor 20 °C DB. Heating Outdoor 7 °C DB / 6 °C WB. [DB: Dry Bulb; WB: Wet Bulb]. Specifications subject to change without notice. For detailed information about ErP / Energy Labelling, please visit our websites www.panasonic.co.uk/aircon or www.ptc.panasonic.eu.



nanoe™ X as a standard.

PACi NX Series Elite adaptive ducted unit Inverter+ · R32

Adaptive ducted unit - PF3.

2 installation possibilities (horizontal / vertical) with high ESP 150 Pa allows for flexible installation.

		Single phase							
		3.6 kW	5.0 kW	6.0 kW	7.1 kW	10.0 kW	12.5 kW	14.0 kW	
Kit		KIT-36PFH3Z5	KIT-50PFH3Z5	KIT-60PFH3Z5	KIT-71PFH3Z5	KIT-100PFH3Z5	KIT-125PFH3Z5	KIT-140PFH3Z5	
Remote controller		CZ-RTC5B	CZ-RTC5B	CZ-RTC5B	CZ-RTC5B	CZ-RTC5B	CZ-RTC5B	CZ-RTC5B	
Cooling capacity	Nominal (Min - Max)	kW	3.6(1.2 - 4.0)	5.0(1.2 - 5.6)	5.7(1.2 - 6.3)	6.8(2.2 - 7.8)	9.5(3.1 - 11.4)	12.1(3.2 - 13.6)	13.4(3.3 - 15.3)
UK cooling	Total - Sensible	kW	3.5 - 2.4	4.9 - 3.2	5.6 - 3.7	7.1 - 4.7	10.4 - 7.2	12.4 - 8.1	13.9 - 8.9
EER ¹⁾	Nominal (Min - Max)	W/W	4.24(3.57 - 5.45)	3.42(3.11 - 5.45)	3.68(3.15 - 5.45)	3.74(2.41 - 5.64)	4.17(2.82 - 5.08)	3.58(3.00 - 5.00)	3.38(2.59 - 4.18)
SEER / η _{sc} ²⁾			6.8 A++	6.1 A++	7.1 A++	7.1 A++	7.4 A++	281.7 %	275.9 %
Pdesign		kW	3.6	5.0	5.7	6.8	9.5	12.1	13.4
Input power	Nominal (Min - Max)	kW	0.85(0.22 - 1.12)	1.46(0.22 - 1.80)	1.55(0.22 - 2.00)	1.82(0.39 - 3.24)	2.28(0.61 - 4.04)	3.38(0.64 - 4.54)	3.96(0.79 - 5.90)
Annual energy consumption ³⁾		kWh/a	185	287	281	332	447	—	—
Heating capacity	Nominal (Min - Max)	kW	4.0(1.2 - 5.0)	5.6(1.2 - 6.5)	7.0(1.2 - 8.0)	7.5(2.0 - 9.0)	10.8(3.1 - 13.5)	13.5(3.2 - 15.4)	15.5(3.3 - 17.4)
UK heating	Total	kW	4.34	5.6	6.92	8.55	12.3	14.5	16.35
COP ¹⁾	Nominal (Min - Max)	W/W	4.17(3.23 - 5.45)	3.61(2.97 - 5.45)	3.74(3.33 - 5.45)	4.03(3.16 - 5.41)	3.97(3.07 - 5.25)	3.46(3.06 - 5.16)	3.44(3.14 - 4.29)
SCOP / η _{sh} ²⁾			4.5 A+	4.2 A+	4.4 A+	4.7 A++	4.5 A+	170.0 %	171.0 %
Pdesign at -10 °C		kW	3.6	4.0	4.7	4.7	7.8	9.3	9.5
Input power	Nominal (Min - Max)	kW	0.96(0.22 - 1.55)	1.55(0.22 - 2.19)	1.87(0.22 - 2.40)	1.86(0.37 - 2.85)	2.72(0.59 - 4.40)	3.90(0.62 - 5.04)	4.51(0.77 - 5.55)
Annual energy consumption ³⁾		kWh/a	1120	1333	1495	1393	2424	—	—
Indoor unit			S-3650PF3E	S-3650PF3E	S-6071PF3E	S-6071PF3E	S-1014PF3E	S-1014PF3E	S-1014PF3E
External static pressure ⁴⁾	Nominal (Min - Max)	Pa	30(10 - 150)	30(10 - 150)	30(10 - 150)	30(10 - 150)	40(10 - 150)	50(10 - 150)	50(10 - 150)
Air flow	Hi / Med / Lo	m ³ /sec	0.23/0.22/0.17	0.27/0.25/0.20	0.35/0.32/0.25	0.35/0.32/0.25	0.53/0.43/0.35	0.57/0.48/0.38	0.60/0.53/0.42
Moisture removal volume		L/h	0.9	1.9	1.7	2.7	3.2	4.1	4.9
Sound pressure ⁵⁾	Hi / Med / Lo	dB(A)	30/27/22	34/30/25	30/26/23	30/26/23	33/29/25	35/31/27	39/35/29
Sound power	Hi / Med / Lo	dB(A)	53/50/45	57/53/48	53/49/46	53/49/46	56/52/48	58/54/50	62/58/52
Dimension	HxWxD	mm	250x800x730	250x800x730	250x1000x730	250x1000x730	250x1400x730	250x1400x730	250x1400x730
Net weight		kg	25	25	30	30	39	39	39
nanoe X Generator			Mark 2	Mark 2	Mark 2	Mark 2	Mark 2	Mark 2	Mark 2
Outdoor unit			U-36PZH3E5	U-50PZH3E5	U-60PZH3E5	U-71PZH3E5	U-100PZH3E5	U-125PZH3E5	U-140PZH3E5
Power supply	V		220 - 230 - 240	220 - 230 - 240	220 - 230 - 240	220 - 230 - 240	220 - 230 - 240	220 - 230 - 240	220 - 230 - 240
Maximum fuse size	A		20	20	25	25	35	40	40
Current	Cool	A	4.20 - 4.00 - 3.85	6.90 - 6.60 - 6.35	7.25 - 6.95 - 6.65	9.00 - 8.60 - 8.25	11.10 - 10.80 - 10.30	16.50 - 15.80 - 15.10	19.60 - 18.70 - 17.90
	Heat	A	4.70 - 4.50 - 4.30	7.35 - 7.00 - 6.75	8.65 - 8.30 - 7.95	9.00 - 8.60 - 8.35	13.30 - 12.70 - 12.20	19.10 - 18.20 - 17.50	22.00 - 21.10 - 20.20
Air flow	Cool / Heat	m ³ /sec	0.57/0.61	0.70/0.70	0.70/0.70	1.02/1.00	1.97/1.80	2.08/1.87	2.15/1.93
Sound pressure	Cool / Heat (Hi)	dB(A)	43/44	46/48	47/50	48/50	52/52	53/53	54/54
Sound power	Cool / Heat (Hi)	dB(A)	62/64	64/67	65/69	65/67	69/69	70/70	71/71
Dimension	HxWxD	mm	695x875x320	695x875x320	695x875x320	996x940x340	1416x940x340	1416x940x340	1416x940x340
Net weight		kg	42	42	43	65	98	98	98
Piping diameter	Liquid pipe	Inch (mm)	1/4(6.35)	1/4(6.35)	1/4(6.35) ⁶⁾	3/8(9.52)	3/8(9.52)	3/8(9.52)	3/8(9.52)
	Gas pipe	Inch (mm)	1/2(12.70)	1/2(12.70)	1/2(12.70) ⁷⁾	5/8(15.88)	5/8(15.88)	5/8(15.88)	5/8(15.88)
Pipe length range		m	3 - 40	3 - 40	3 - 40	5 - 50	5 - 85	5 - 85	5 - 85
Elevation difference (in / out) ⁸⁾		m	15/30	15/30	15/30	15/30	15/30	15/30	15/30
Pipe length for additional gas		m	30	30	30	30	30	30	30
Additional gas amount		g/m	15	15	15	45	45	45	45
Refrigerant (R32) / CO ₂ Eq.		kg / T	1.13/0.76	1.13/0.76	1.15/0.78	1.95/1.32	3.05/2.06	3.05/2.06	3.05/2.06
Operating range	Cool Min - Max	°C	-15 ~ +46	-15 ~ +46	-15 ~ +46	-15 ~ +48	-20 ~ +48 ⁹⁾	-20 ~ +48 ⁹⁾	-20 ~ +48 ⁹⁾
	Heat Min - Max	°C	-20 ~ +24	-20 ~ +24	-20 ~ +24	-20 ~ +24	-20 ~ +24	-20 ~ +24	-20 ~ +24
Kit RRP	£		2.111	2.303	2.653	3.047	3.829	4.103	4.543
Indoor unit RRP	£		855	855	1.062	1.062	1.362	1.362	1.362
Outdoor unit RRP	£		1.112	1.304	1.447	1.841	2.323	2.597	3.037
Wired control RRP	£		144	144	144	144	144	144	144

Technical focus

- 2 installation possibilities (horizontal / vertical)
- Maximum external static pressure: 150 Pa
- Selectable inlet air position (rear / bottom entry)
- Improved drain pan suitable for both horizontal / vertical installation
- Drain pump included
- nanoe™ X (Generator Mark 2= 9.6 trillion hydroxyl radicals/sec) as standard for the long duct piping case*
- Wired remote control CZ-RTC6BL allows easy system setting via Bluetooth®

* The performance of nanoe™ X air can be expected even by 10 m long duct by Panasonic internal survey.

2 installation possibilities (horizontal / vertical)

Vertical installation is newly available. ESP 150 Pa, sufficient for remotely installing units away from the rooms.



Improved drain pan design

Drain pan is shared in both cases horizontal and vertical installation. No need to modify the unit.

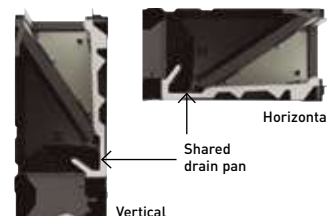



CZ-RTC5B



Optional controller.
CONEX wired remote controller.
CZ-RTC6 - CZ-RTC6BL
- CZ-RTC6BLW



Optional controller.
Infrared remote controller.
CZ-RWS3 +
CZ-RWRC3



Optional Econavi sensor.
CZ-CENSC1

COMPATIBLE WITH ALL PANASONIC CONNECTIVITY SOLUTIONS. FOR DETAILED INFORMATION GO TO THE CONTROL SYSTEMS SECTION

			Three phase			
			7.1 kW	10.0 kW	12.5 kW	14.0 kW
Kit			KIT-71PFH3Z8	KIT-100PFH3Z8	KIT-125PFH3Z8	KIT-140PFH3Z8
Remote controller			CZ-RTC5B	CZ-RTC5B	CZ-RTC5B	CZ-RTC5B
Cooling capacity	Nominal (Min - Max)	kW	6.8[2.2 - 7.8]	9.5[3.1 - 11.4]	12.1[3.2 - 13.6]	13.4[3.3 - 15.3]
UK cooling	Total - Sensible	kW	7.1-4.7	10.4-7.2	12.4-8.1	13.9-8.9
EER ¹⁾	Nominal (Min - Max)	W/W	3.74[5.64 - 2.41]	4.17[5.08 - 2.82]	3.58[5.00 - 3.00]	3.38[4.18 - 2.59]
SEER / η_{sc} ²⁾			7.0 A++	7.3 A++	281.0 %	275.2 %
Pdesign		kW	6.8	9.5	12.1	13.4
Input power	Nominal (Min - Max)	kW	1.82[0.39 - 3.24]	2.28[0.61 - 4.04]	3.38[0.64 - 4.54]	3.96[0.79 - 5.90]
Annual energy consumption ³⁾		kWh/a	338	451	—	—
Heating capacity	Nominal (Min - Max)	kW	7.5[2.0 - 9.0]	10.8[3.1 - 13.5]	13.5[3.2 - 15.4]	15.5[3.3 - 17.4]
UK heating	Total	kW	8.55	12.3	14.5	16.35
COP ¹⁾	Nominal (Min - Max)	W/W	4.03[5.41 - 3.16]	3.97[5.25 - 3.07]	3.46[5.16 - 3.06]	3.44[4.29 - 3.14]
SCOP / η_{sh} ²⁾			4.7 A++	4.5 A+	170.0 %	171.0 %
Pdesign at -10 °C		kW	4.7	7.8	9.3	9.5
Input power	Nominal (Min - Max)	kW	1.86[0.37 - 2.85]	2.72[0.59 - 4.40]	3.9[0.62 - 5.04]	4.51[0.77 - 5.55]
Annual energy consumption ³⁾		kWh/a	1394	2424	—	—
Indoor unit			S-6071PF3E	S-1014PF3E	S-1014PF3E	S-1014PF3E
External static pressure ⁴⁾	Nominal (Min - Max)	Pa	30[10 - 150]	40[10 - 150]	50[10 - 150]	50[10 - 150]
Air flow	Hi / Med / Lo	m ³ /sec	0.35/0.32/0.25	0.53/0.43/0.35	0.57/0.48/0.38	0.60/0.53/0.42
Moisture removal volume		L/h	2.7	3.2	4.1	4.9
Sound pressure ⁵⁾	Hi / Med / Lo	dB(A)	30/26/23	33/29/25	35/31/27	39/35/29
Sound power	Hi / Med / Lo	dB(A)	53/49/46	56/52/48	58/54/50	62/58/52
Dimension	HxWxD	mm	250x1000x730	250x1400x730	250x1400x730	250x1400x730
Net weight		kg	30	39	39	39
nanoe X Generator			Mark 2	Mark 2	Mark 2	Mark 2
Outdoor unit			U-71PZH3E8	U-100PZH3E8	U-125PZH3E8	U-140PZH3E8
Power supply		V	380 - 400 - 415	380 - 400 - 415	380 - 400 - 415	380 - 400 - 415
Maximum fuse size		A	15	15	15	15
Current	Cool	A	3.00 - 2.90 - 2.80	3.80 - 3.60 - 3.50	5.60 - 5.30 - 5.15	6.60 - 6.30 - 6.05
	Heat	A	3.05 - 2.95 - 2.85	4.50 - 4.30 - 4.15	6.45 - 6.10 - 5.90	7.55 - 7.15 - 6.90
Air flow	Cool / Heat	m ³ /sec	1.02/1.00	1.97/1.80	2.08/1.87	2.15/1.93
Sound pressure	Cool / Heat (Hi)	dB(A)	48/50	52/52	53/53	54/54
Sound power	Cool / Heat (Hi)	dB(A)	65/67	69/69	70/70	71/71
Dimension	HxWxD	mm	996x940x340	1416x940x340	1416x940x340	1416x940x340
Net weight		kg	65	98	98	98
Piping diameter	Liquid pipe	Inch (mm)	3/8(9.52)	3/8(9.52)	3/8(9.52)	3/8(9.52)
	Gas pipe	Inch (mm)	5/8(15.88)	5/8(15.88)	5/8(15.88)	5/8(15.88)
Pipe length range		m	5 - 50	5 - 85	5 - 85	5 - 85
Elevation difference (in / out) ⁶⁾		m	15/30	15/30	15/30	15/30
Pipe length for additional gas		m	30	30	30	30
Additional gas amount		g/m	45	45	45	45
Refrigerant (R32) / CO ₂ Eq.		kg / T	1.95/1.32	3.05/2.06	3.05/2.06	3.05/2.06
Operating range	Cool Min ~ Max	°C	-15 ~ +48	-20 ~ +48 ¹⁰⁾	-20 ~ +48 ⁷⁾	-20 ~ +48 ⁷⁾
	Heat Min ~ Max	°C	-20 ~ +24	-20 ~ +24	-20 ~ +24	-20 ~ +24
Kit RRP		£	3.100	3.866	4.219	4.862
Indoor unit RRP		£	1.062	1.362	1.362	1.362
Outdoor unit RRP		£	1.894	2.360	2.713	3.356
Wired control RRP		£	144	144	144	144

1) EER and COP calculation is based in accordance to EN14511. 2) For models below 12 kW, the SEER and SCOP is calculated based on values of EU/626/2011. For models above 12 kW, the η_{sc} / η_{sh} values is calculated based on EN 14825. 3) Factory setting. 4) Medium external static pressure setting from factory. 5) The sound pressure of the units shows the value measured of the position 1.5 m below the unit. The sound pressure is measured in accordance with Eurovent 6/C/006-97 specification. 6) Connect the liquid socket tube [06.35-09.52] to the liquid tubing side indoor unit. 7) Connect the gas socket tube [012.70-015.88] to the gas tubing side indoor unit. 8) Outdoor unit located lower / outdoor unit located higher. 9) For models 100 ~ 140PZH3E5[8], it is possible to operate the lowest -20 °C in the computer rooms with the piping length of 30 m or less. * Recommended fuse for the indoor 3 A. ** Above values are in the case of standard installation(horizontal installation in the ceiling, rear side air intake) and nanoe™ X OFF.

Accessories		RRP £
CZ-RTC6	CONEX wired remote controller (non-wireless)	144
CZ-RTC6BL	CONEX wired remote controller with Bluetooth®	172
CZ-RTC6BLW	CONEX wired remote controller with Wi-Fi and Bluetooth®	242
CZ-RTC5B	Wired remote controller with Econavi function and datanavi	144
CZ-RWS3 + CZ-RWRC3	Infrared remote controller and receiver	276
CZ-CAPWFC1	Commercial Wi-Fi Adaptor	176
PAW-PACR3	Interfaces to run 3 units on back-up and alternative run	1.745

Accessories		RRP £
PAW-WTRAY	Tray for condenser water compatible with outdoor elevation platform	133
PAW-GRDBSE20	Outdoor base ground support for noise and vibration absorption	122
PAW-GRDSTD40	Outdoor elevation platform 400x900x400 mm	133
CZ-CENSC1	Econavi energy savings sensor	151
CZ-56DAF2	Air outlet plenum for S-3650PF3E	172
CZ-90DAF2	Air outlet plenum for S-6071PF3E	211
CZ-160DAF2	Air outlet plenum for S-1014PF3E	242



SEER and SCOP: For S-6071PF3E + U-71PZH3E5. SUPER QUIET: For S-3650PF3E + U-36PZH3E5. INTERNET CONTROL: Optional.

Rating Conditions: Cooling Indoor 27 °C DB / 19 °C WB. Cooling Outdoor 35 °C DB / 24 °C WB. Heating Indoor 20 °C DB. Heating Outdoor 7 °C DB / 6 °C WB. [DB: Dry Bulb; WB: Wet Bulb]. Specifications subject to change without notice. For detailed information about ErP / Energy Labelling, please visit our websites www.panasonic.co.uk/aircon or www.ptc.panasonic.eu.



Panasonic Big PACi high static pressure hide-away 20.0-25.0 kW Inverter+ · R32

Panasonic Big PACi, not only environmental friendly but also a groundbreaking product.

Big PACi with R32 has been introduced with full renewal of its indoor unit, also offering hydronic application by PACi Water heat exchanger.



1 Compact and light indoor body

Compact and light indoor body, keeping the high efficiency, has a split-able design for easy installation within a limited narrow space. Plus ease of maintenance due to the simplified disassembly design.

2 Easy pipe work with split-able hide-away indoor design

Heat exchanger and fan elements (fan + casing) can be separated during installation. The hide-away indoor unit is easily reassembled and will fit through a narrow space.

3 High external static pressure, maximum 200 Pa* setting

A high static pressure enables the use of long ducts for installation in a wide range of spaces.

* S-250PE3E5B.

4 Panasonic Comfort Cloud App control

Smartphone ready to control of PACi systems with Panasonic Comfort Cloud App*.

* Panasonic Wi-Fi Adaptor CZ-CAPWFC1 is required.

Compact and light indoor body, keeping high efficiency

15 % lighter weight vs conventional model drastically improves installation work.

	Conventional model	Panasonic model
20.0 kW	100 kg	86 kg
25.0 kW	104 kg	88 kg

DEPTH WAS REDUCED BY 230 mm



Maximum 200 Pa* static pressure setting

A high static pressure enables the use of long ducts for installation in a wide range of spaces.

3-step static pressure set up.

Selectable of static pressure modes can change 200 Pa / 130 Pa / 75 Pa for extra installation flexibility.

* In case of S-250PE3E5B.



Easy installation with light components

Indoor unit can easily be split into 3 components, the heaviest of which weighs only 48 kg.



Dimensions of each component (lightweight design for easy disassembly).



The weight is for S-200PE3E5B model.



COMPATIBLE WITH ALL PANASONIC CONNECTIVITY SOLUTIONS. FOR DETAILED INFORMATION GO TO THE CONTROL SYSTEMS SECTION

CONEX



Optional controller.
CONEX wired remote controller.
CZ-RTC6 - CZ-RTC6BL



Optional controller.
Infrared remote controller.
CZ-RWS3 + CZ-RWRC3



Optional Econavi sensor.
CZ-CENSC1

Three phase

			20.0 kW	25.0 kW
Kit			KIT-200PE3ZH8	KIT-250PE3ZH8
Remote controller			CZ-RTC5B	CZ-RTC5B
Cooling capacity	Nominal (Min - Max)	kW	19.5 (5.7 - 21.0)	23.2 (6.1 - 27.0)
UK cooling	Total - Sensible	kW	20.8 - 14.0	26.9 - 17.4
EER ¹⁾	Nominal (Min - Max)	W/W	3.22 (3.09 - 4.52)	3.11 (2.93 - 4.59)
SEER / η_{sc} ²⁾			207.0 %	190.6 %
Pdesign		kW	19.5	23.2
Input power	Nominal (Min - Max)	kW	6.06 (1.26 - 6.80)	7.46 (1.33 - 9.20)
Heating capacity	Nominal (Min - Max)	kW	22.4 (5.0 - 25.0)	28.0 (5.5 - 29.0)
UK heating	Total	kW	24.41	28.31
COP ¹⁾	Nominal (Min - Max)	W/W	3.61 (3.16 - 4.76)	3.41 (3.05 - 5.00)
SCOP / η_{sh} ²⁾			141.3 %	142.7 %
Pdesign at -10 °C		kW	17.0	20.0
Input power	Nominal (Min - Max)	kW	6.21 (1.05 - 7.90)	8.21 (1.10 - 9.50)
Indoor unit			S-200PE3E5B	S-250PE3E5B
Power supply		V / ph / Hz	220 - 230 - 240 / 1/50	220 - 230 - 240 / 1/50
External static pressure at shipment (adjustable)		Pa	75 ³⁾ - 120 - 180	75 ³⁾ - 130 - 200
Air flow	Hi / Med / Lo	m ³ /sec	1.20 / 1.05 / 0.88	1.40 / 1.20 / 0.98
Sound pressure ⁴⁾	Hi / Med / Lo	dB(A)	46 / 44 / 41	47 / 45 / 42
Dimension	H x W x D	mm	486 x 1456 x 916	486 x 1456 x 916
Net weight		kg	86	88
Outdoor unit			U-200PZH2E8	U-250PZH2E8
Power supply		V / ph / Hz	380 - 400 - 415 / 3/50	380 - 400 - 415 / 3/50
Maximum fuse size		A	30	30
Air flow	Cool / Heat	m ³ /sec	2.73 / 2.73	2.67 / 2.67
Sound pressure	Cool / Heat (Hi)	dB(A)	59 / 61	59 / 63
Sound power	Cool / Heat (Hi)	dB(A)	77 / 79	78 / 82
Dimension ⁵⁾	H x W x D	mm	1500 x 980 x 370	1500 x 980 x 370
Net weight		kg	117	128
Piping diameter	Liquid pipe	Inch (mm)	3/8 (9.52)	1/2 (12.70)
	Gas pipe	Inch (mm)	1 (25.40)	1 (25.40)
Pipe length range		m	5 - 90	5 - 60
Elevation difference (in / out)		m	30	30
Pipe length for additional gas		m	30	30
Additional gas amount		g/m	60	80
Refrigerant (R32) / CO ₂ Eq.		kg / T	4.20 / 2.835	5.20 / 3.51
Operating range	Cool Min ~ Max	°C	-15 ~ +46	-15 ~ +46
	Heat Min ~ Max	°C	-20 ~ +24	-20 ~ +24
Kit RRP		£	6.650	7.293
Indoor unit RRP		£	3.105	3.288
Outdoor unit RRP		£	3.401	3.861
Wired control RRP		£	144	144

1) EER and COP calculation is based in accordance to EN14511. 2) For models below 12 kW, the SEER and SCOP is calculated based on values of EU/626/2011. For models above 12 kW, the η_{sc} / η_{sh} values is calculated based on EN 14825. 3) Factory setting. 4) The sound pressure of the units shows the value measured of the position 1.5 m below the unit. The sound pressure is measured in accordance with Eurovent 6/C/006-97 specification. 5) Add 100 mm for indoor unit or 70 mm for outdoor unit for piping port. * No filter included.

Accessories	RRP £
CZ-RTC6 CONEX wired remote controller (non-wireless)	144
CZ-RTC6BL CONEX wired remote controller with Bluetooth®	172
CZ-RTC5B Wired remote controller with Econavi function and datanavi	144
CZ-RWS3 + CZ-RWRC3 Infrared remote controller and receiver	276

Accessories	RRP £
CZ-CAPWFC1 Commercial Wi-Fi Adaptor	176
PAW-PACR3 Interfaces to run 3 units on back-up and alternative run	1.745
PAW-GRDBSE20 Outdoor base ground support for noise and vibration absorption	122
PAW-GRDSTD40 Outdoor elevation platform 400 x 900 x 400 mm	133
CZ-CENSC1 Econavi energy savings sensor	151



INTERNET CONTROL: Optional.

Rating Conditions: Cooling Indoor 27 °C DB / 19 °C WB. Cooling Outdoor 35 °C DB / 24 °C WB. Heating Indoor 20 °C DB. Heating Outdoor 7 °C DB / 6 °C WB. (DB: Dry Bulb; WB: Wet Bulb). Specifications subject to change without notice. For detailed information about ErP / Energy Labelling, please visit our websites www.panasonic.co.uk/aircon or www.ptc.panasonic.eu.



PACi Elite 4 way 60x60 cassette Inverter+ · R32

Small and powerful, ideal for offices and restaurants.



Technical focus

- Fresh air distribution
- Multidirectional air flow
- Integrated drain pump gives 750 mm lift
- 3 speed centrifugal fan
- DC fan for better efficiency and control
- Easy connection and control of external fan or ERV using the connector PAW-FDC on the indoor unit PCB. The external device can be controlled by the remote control of the Panasonic indoor unit

Lighter and slimmer, easier installation

Lightweight and very slim which makes installation possible even in narrow ceilings. Designed to fit exactly into a 600x600 mm ceiling grid without the need to alter the bar configuration.

A drain height of approximately 750 mm from the ceiling surface

The drain height can be increased by approx. 350 mm over the conventional value by using a high-lift drain pump, and long horizontal piping is possible.

Lightweight at 18kg, the unit is also very slim with a height of only 288 mm, making installation possible even in narrow ceilings.

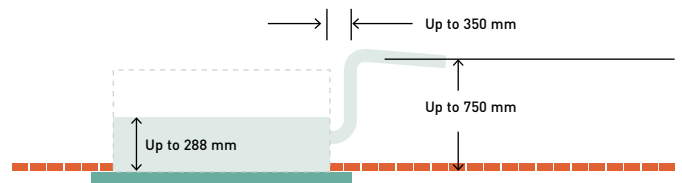

Significant reduction of power consumption by using highly developed DC fan motors with variable speed, special heat exchangers, etc.



CZ-RTC5B

COMPATIBLE WITH ALL PANASONIC CONNECTIVITY SOLUTIONS. FOR DETAILED INFORMATION GO TO THE CONTROL SYSTEMS SECTION



Panel 700 x 700 mm.
CZ-KPY3AW

Panel 625 x 625 mm.
CZ-KPY3BW



Optional controller.
CONEX wired remote controller.
CZ-RTC6 - CZ-RTC6BL



Optional controller.
Infrared remote controller.
CZ-RWS3

Single phase

Kit			3.6 kW	5.0 kW
			KIT-36PY2ZH5	KIT-50PY2ZH5
Remote controller			CZ-RTC5B	CZ-RTC5B
Cooling capacity	Nominal (Min - Max)	kW	3.6(1.5 - 4.0)	5.0(1.5 - 5.6)
UK cooling	Total - Sensible	kW	4.00 - 2.90	5.50 - 3.80
EER ¹⁾		W/W	4.68	3.68
SEER / η_{sc} ²⁾			6.6 A++	6.4 A++
Pdesign		kW	3.6	5.0
Input power		kW	0.77	1.36
Annual energy consumption ³⁾		kWh/a	191	273
Heating capacity	Nominal (Min - Max)	kW	4.0(1.5 - 5.0)	5.6(1.5 - 6.5)
UK heating	Total	kW	4.6	6.0
COP ¹⁾		W/W	4.26	3.46
SCOP / η_{sh} ²⁾			4.6 A++	4.3 A+
Pdesign at -10 °C		kW	3.6	4.5
Input power		kW	0.94	1.62
Annual energy consumption ³⁾		kWh/a	1096	1465
Indoor unit			S-36PY2E5B	S-50PY2E5B
Maximum fuse size		A	5	5
Air flow	Hi / Med / Lo	m ³ /sec	0.16/0.13/0.10	0.19/0.16/0.14
Moisture removal volume		L/h	1.5	2.4
Sound pressure ⁴⁾	Hi / Med / Lo	dB(A)	36/32/26	40/37/33
Sound power	Hi / Med / Lo	dB(A)	51/47/41	55/52/48
Dimension (H x W x D) / Net weight	Indoor	mm / kg	288 x 583 x 583 / 18	288 x 583 x 583 / 18
	CZ-KPY3AW Panel	mm / kg	31 x 700 x 700 / 2.4	31 x 700 x 700 / 2.4
	CZ-KPY3BW Panel	mm / kg	31 x 625 x 625 / 2.4	31 x 625 x 625 / 2.4
Outdoor unit			U-36PZH2E5	U-50PZH2E5
Power supply		V	220 - 230 - 240	220 - 230 - 240
Fuse size	Recommended / Max	A	16 / 20	16 / 20
Current	Cool	A	3.65 - 3.50 - 3.35	6.35 - 6.10 - 5.85
	Heat	A	4.50 - 4.30 - 4.15	7.70 - 8.40 - 8.10
Air flow	Cool / Heat	m ³ /sec	0.67/0.67	0.67/0.75
Sound pressure	Cool / Heat (Hi)	dB(A)	43/44	45/48
Sound power	Cool / Heat (Hi)	dB(A)	62/64	64/68
Dimension / Net weight	H x W x D	mm / kg	695 x 875 x 320 / 43	695 x 875 x 320 / 43
Piping diameter	Liquid pipe	Inch (mm)	1/4 (6.35)	1/4 (6.35)
	Gas pipe	Inch (mm)	1/2 (12.70)	1/2 (12.70)
Pipe length range		m	3 - 40	3 - 40
Elevation difference (in / out) ⁵⁾		m	15/30	15/30
Pipe length for additional gas		m	30	30
Additional gas amount		g/m	20	20
Refrigerant (R32) / CO ₂ Eq.		kg / T	1.15/0.776	1.15/0.776
Operating range	Cool Min ~ Max	°C	-15 ~ +46	-15 ~ +46
	Heat Min ~ Max	°C	-20 ~ +24	-20 ~ +24
Kit RRP		£	2,186	2,448
Indoor unit RRP		£	688	762
Outdoor unit RRP		£	1,121	1,309
Panel RRP		£	233	233
Wired control RRP		£	144	144

1) EER and COP calculation is based in accordance to EN14511. 2) Energy Label Scale from A+++ to D. For models below 12 kW, the SEER and SCOP is calculated based on values of EU/626/2011. For models above 12 kW, the η_{sc} / η_{sh} values is calculated based on EN 14825. 3) The annual energy consumption is calculated in accordance to EU/626/2011. 4) The sound pressure of the units shows the value measured of the position 1.5 m below the unit. The sound pressure is measured in accordance with Eurovent 6/C/006-97 specification. 5) Outdoor unit located lower / outdoor unit located higher. * Recommended fuse for the indoor 3 A.

Accessories	RRP £
CZ-RTC6 CONEX wired remote controller (non-wireless)	144
CZ-RTC6BL CONEX wired remote controller with Bluetooth®	172
CZ-RTC5B Wired remote controller with Econavi function and datanavi	144
CZ-RWS3 Infrared remote controller	108
CZ-CAPWFC1 Commercial Wi-Fi Adaptor	176
PAW-PACR3 Interfaces to run 3 units on back-up and alternative run	1,745

Accessories	RRP £
PAW-WTRAY Tray for condenser water compatible with outdoor elevation platform	133
PAW-GRDBSE20 Outdoor base ground support for noise and vibration absorption	122
PAW-GRDSTD40 Outdoor elevation platform 400 x 900 x 400 mm	133
CZ-CENSC1 Econavi energy savings sensor	151



SEER and SCOP: For KIT-36PY2ZH5. INTERNET CONTROL: Optional.

Rating Conditions: Cooling Indoor 27 °C DB / 19 °C WB. Cooling Outdoor 35 °C DB / 24 °C WB. Heating Indoor 20 °C DB. Heating Outdoor 7 °C DB / 6 °C WB. (DB: Dry Bulb; WB: Wet Bulb). Specifications subject to change without notice. For detailed information about ErP / Energy Labelling, please visit our websites www.panasonic.co.uk/aircon or www.ptc.panasonic.eu.

Commercial single, twin, triple and double-twin systems - R32

With this system, a single outdoor unit can split its capacity simultaneously across up to 4 indoor units, for better distribution within the space. This makes the system particularly apt for common areas. It reduces noise concentration and enables the same temperature to be reached around the room. A wide variety of the same type of indoor units can be connected in multi combinations (including wall-mounted, cassette, hide-away and ceiling).

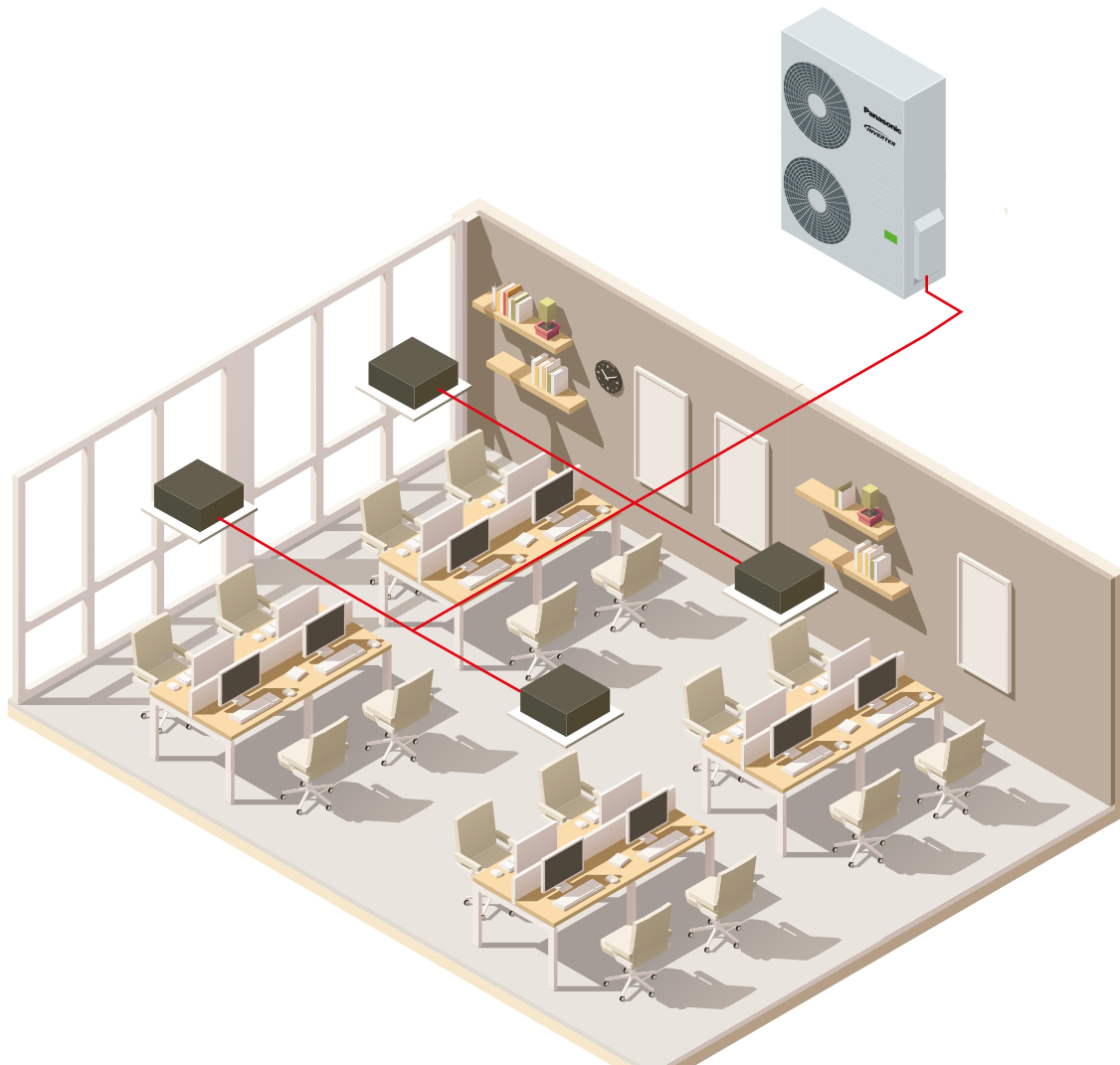

1 PACi NX Elite from 7.1 to 14.0 kW

Up to 4 indoor units can be connected to the same outdoor unit. Panasonic's Elite units 7.1, 10.0, 12.0 and 14.0 can be installed as twin, triple and double-twin systems. The indoor units can be combined as per the selection table. The operation will always be simultaneous. All the indoor units will work with the same settings.

2 PACi NX Standard from 10.0 to 14.0 kW

Up to 2 indoor units connectable on the same outdoor. Panasonic's Standard units can be installed as single and twin systems. The indoor units can be combined following the selection table. The operation will always be simultaneous. All the indoor units will work with the same settings.

3 Big PACi Elite from 20.0 to 25.0 kW

Up to 4 indoor units can be connected to the same outdoor unit. Panasonic's PACi units 20.0 and 25.0 can be installed as twin, triple and double-twin systems. The indoor units can be combined as per the selection table. The operation will always be simultaneous. All the indoor units will work with the same settings.

PACi NX Elite from 7,1 to 14,0 kW simultaneous operation system combinations - R32

Capacity	Indoor	Outdoor			
		7,1 kW	10,0 kW	12,5 kW	14,0 kW
3,6 kW	S-36PY3E				
	S-3650PF3E				
	S-3650PK3E				
	S-3650PT3E				
S-3650PU3E					
4,5 kW	S-3650PF3E				
	S-3650PK3E				
	S-3650PT3E				
	S-3650PU3E				
5,0 kW	S-50PY3E				
	S-3650PF3E				
	S-3650PK3E				
	S-3650PT3E				
	S-3650PU3E				
6,0 kW	S-60PY3E				
	S-6071PF3E				
	S-6010PK3E				
	S-6071PT3E				
S-6071PU3E					
7,1 kW	S-6071PF3E				
	S-6010PK3E				
	S-6071PT3E				
	S-6071PU3E				

PACi NX Standard from 10,0 to 14,0 kW simultaneous operation system combinations - R32

Capacity	Indoor	Outdoor		
		10,0 kW	12,5 kW	14,0 kW
5,0 kW	S-50PY3E			
	S-3650PF3E			
	S-3650PK3E			
	S-3650PT3E			
	S-3650PU3E			
6,0 kW	S-60PY3E			
	S-6071PF3E			
	S-6010PK3E			
	S-6071PT3E			
	S-6071PU3E			
7,1 kW	S-6071PF3E			
	S-6010PK3E			
	S-6071PT3E			
	S-6071PU3E			

Big PACi Elite from 20,0 to 25,0 kW simultaneous operation system combinations - R32

Capacity	Indoor	Outdoor	
		20,0 kW	25,0 kW
5,0 kW	S-50PY3E		
	S-3650PF3E		
	S-3650PK3E		
	S-3650PT3E		
	S-3650PU3E		
6,0 kW	S-60PY3E		
	S-6071PF3E		
	S-6010PK3E		
	S-6071PT3E		
	S-6071PU3E		
7,1 kW	S-6071PF3E		
	S-6010PK3E		
	S-6071PT3E		
	S-6071PU3E		
10,0 kW	S-1014PF3E		
	S-6010PK3E		
	S-1014PT3E		
	S-1014PU3E		
12,5 kW	S-1014PF3E		
	S-1014PT3E		
	S-1014PU3E		

1) PACi 1x1 Kit solution.

Commercial twin, triple and double-twin systems - R32



PACi outdoor units - R32

		PACi NX Standard			PACi NX Elite				Big PACi		
		10.0 kW	12.5 kW	14.0 kW	7.1 kW	10.0 kW	12.5 kW	14.0 kW	20.0 kW	25.0 kW	
Outdoor unit single phase		U-	100PZ3E5	125PZ3E5	140PZ3E5	71PZH3E5	100PZH3E5	125PZH3E5	140PZH3E5	—	—
Outdoor unit three phase		U-	100PZ3E8	125PZ3E8	140PZ3E8	71PZH3E8	100PZH3E8	125PZH3E8	140PZH3E8	200PZH2E8	250PZH2E8
Cooling capacity	Nominal	kW	10.0	12.5	14.0	6.8	9.5	12.1	13.4	20.0	25.0
	Min		3.0	3.2	3.3	2.2	3.1	3.2	3.3	5.7	6.1
	Max		11.5	13.5	15.0	9.0	12.5	14.0	16.0	22.4	28.0
Heating capacity	Nominal	kW	10.0	12.5	14.0	8.0	11.2	14.0	16.0	22.4	28.0
	Min		3.0	3.3	3.4	2.0	3.1	3.2	3.3	5.0	5.5
	Max		14.0	15.0	16.0	9.0	14.0	16.0	18.0	25.0	31.5
Power supply	Single phase	V	220 - 230 - 240	220 - 230 - 240	220 - 230 - 240	220 - 230 - 240	220 - 230 - 240	220 - 230 - 240	220 - 230 - 240	—	—
	Three phase	V	380 - 400 - 415	380 - 400 - 415	380 - 400 - 415	380 - 400 - 415	380 - 400 - 415	380 - 400 - 415	380 - 400 - 415	380 - 400 - 415	380 - 400 - 415
Connection indoor / outdoor		mm ²	2x1.5 or 2.5	2x1.5 or 2.5	2x1.5 or 2.5	2x1.5 or 2.5	2x1.5 or 2.5	2x1.5 or 2.5	2x1.5 or 2.5	—	—
Air flow	Cool / Heat	m ³ /sec	1.22/1.22	1.37/1.33	1.40/1.37	1.02/1.00	1.97/1.80	2.08/1.87	2.15/1.93	2.73/2.73	2.67/2.67
Sound pressure	Cool / Heat (Hi)	dB(A)	52/52	55/55	56/56	48/50	52/52	53/53	54/54	59/61	59/63
Sound power	Cool / Heat (Hi)	dB(A)	70/70	73/73	74/74	65/67	69/69	70/70	71/71	77/79	78/82
Dimension	H x W x D	mm	996 x 980 x 370	996 x 980 x 370	996 x 980 x 370	996 x 940 x 340	1416 x 940 x 340	1416 x 940 x 340	1416 x 940 x 340	1500 x 980 x 370	1500 x 980 x 370
Net weight		kg	83	87	87	65	98	98	98	117	128
Piping diameter	Liquid pipe	Inch (mm)	3/8 (9.52)	3/8 (9.52)	3/8 (9.52)	3/8 (9.52)	3/8 (9.52)	3/8 (9.52)	3/8 (9.52)	3/8 (9.52)	1/2 (12.70)
	Gas pipe	Inch (mm)	5/8 (15.88)	5/8 (15.88)	5/8 (15.88)	5/8 (15.88)	5/8 (15.88)	5/8 (15.88)	5/8 (15.88)	1 (25.40)	1 (25.40)
Pipe length range	Min ~ Max	m	5 ~ 50	5 ~ 50	5 ~ 50	5 ~ 50	5 ~ 85	5 ~ 85	5 ~ 85	5 ~ 80	5 ~ 60
Elevation difference (in / out)	Max	m	15/30	15/30	15/30	15/30 ¹⁾	15/30 ¹⁾	15/30 ¹⁾	15/30 ¹⁾	30	30
Pipe length for additional gas		m	30	30	30	30	30	30	30	30	30
Additional gas amount		g/m	45	45	45	45	45	45	45	60	80
Refrigerant (R32) / CO ₂ Eq.		kg / T	2.4/1.62	2.8/1.89	2.8/1.89	1.95/1.32	3.05/2.06	3.05/2.06	3.05/2.06	4.20/2.835	5.20/3.51
Operating range	Cool Min ~ Max	°C	-10 ~ +43	-10 ~ +43	-10 ~ +43	-15 ~ 48	-20 ~ +48 ²⁾	-20 ~ +48 ²⁾	-20 ~ +48 ²⁾	-15 ~ +46	-15 ~ +46
	Heat Min ~ Max	°C	-15 ~ 24	-15 ~ 24	-15 ~ 24	-20 ~ 24	-20 ~ 24	-20 ~ 24	-20 ~ 24	-20 ~ +24	-20 ~ +24
Outdoor unit single phase RRP		£	1.595	1.903	2.534	1.841	2.323	2.597	3.037	—	—
Outdoor unit three phase RRP		£	1.693	1.963	2.564	1.894	2.360	2.713	3.356	3.401	3.861

1) Outdoor unit located lower / outdoor unit located higher. 2) For models 100 ~ 140PZH3E5(8), it is possible to operate the lowest -20 °C in the computer rooms with the piping length of 30 m or less.

Pipe size combinations

PACi NX Standard 10.0 to 14.0 kW

Outdoor model	Indoor capacity	Outdoor to branch	Between branches	Branch to indoor	Branch Pipe
U-100PZ3E5/8	Twin (50 x 2)	3/8 - 5/8		1/4 - 1/2	P224BK2BM
U-125PZ3E5/8	Twin (60 x 2)	3/8 - 5/8		3/8 - 5/8	P224BK2BM
U-140PZ3E5/8	Twin (71 x 2)	3/8 - 5/8		3/8 - 5/8	P224BK2BM

PACi NX Elite 7.1 to 14.0 kW

Outdoor model	Indoor capacity	Outdoor to branch	Between branches	Branch to indoor	Branch Pipe
U-71PZH3E5/8	Twin (36 x 2)	3/8 - 5/8		1/4 - 1/2	P224BK2BM
U-100PZH3E5/8	Twin (50 x 2)	3/8 - 5/8		1/4 - 1/2	P224BK2BM
U-125PZH3E5/8	Twin (60 x 2)	3/8 - 5/8		3/8 - 5/8	P224BK2BM
U-140PZH3E5/8	Twin (71 x 2)	3/8 - 5/8		3/8 - 5/8	P224BK2BM
U-100PZH3E5/8	Triple (36 x 3)	3/8 - 5/8		1/4 - 1/2	P3HPC2BM
U-125PZH3E5/8	Triple (45 x 3)	3/8 - 5/8		1/4 - 1/2	P3HPC2BM
U-140PZH3E5/8	Triple (50 x 3)	3/8 - 5/8		1/4 - 1/2	P3HPC2BM
U-125PZH3E5/8	Double-twin (36 x 4)	3/8 - 5/8	3/8 - 5/8	1/4 - 1/2	P224BK2BM x3

Pipe size combinations

PACi Elite 20.0 to 25.0 kW

Outdoor model	Indoor capacity	Outdoor to branch	Between branches	Branch to indoor	Branch Pipe	Branch Pipe
U-200PZH2E8	Twin (100 x 2)	3/8-1 1/8		3/8-5/8	P680BK2BM	
U-200PZH2E8	Triple (71 x 3)	3/8-1 1/8		3/8-5/8	P3HPC2BM	
U-200PZH2E8	Double-twin (50 x 4)	3/8-1 1/8	3/8-5/8	1/4-1/2	P680BK2BM	P224BK2BM x2
U-250PZH2E8	Twin (125 x 2)	1/2-1 1/8		3/8-5/8	P680BK2BM	
U-250PZH2E8	Double-twin (60 x 4)	1/2-1 1/8	3/8-5/8	3/8-5/8	P680BK2BM	P224BK2BM x2

Compatible indoor units for multi combinations

CONEX



Optional controller.
CONEX wired remote
controller.
CZ-RTC6 - CZ-RTC6BL



Optional controller.
Wired remote
controller.
CZ-RTC5B



Optional Econavi
sensor.
CZ-CENSC1



INTERNET CONTROL: Optional.



Wall-mounted	Indoor unit	Cooling capacity	Heating capacity	Dimension	Sound pressure	Air flow	RRP
		kW	kW	HxWxD mm	Hi / Med / Lo dB(A)	Hi / Med / Lo m³/sec	
3.6 / 4.5 / 5.0 kW	S-3650PK3E	3.6 - 5.0	4.0 - 5.6	302 x 1120 x 236	35/31/27 ¹⁾	0.22/0.18/0.15 ¹⁾	754
6.0 / 7.1 kW	S-6010PK3E	6.1 - 10.0	7.0 - 8.0	302 x 1120 x 236	47/44/40 ¹⁾	0.33/0.29/0.24 ¹⁾	981



INTERNET CONTROL: Optional.



4 way 60x60 cassette	Indoor unit (panel CZ-KPY4)	Cooling capacity	Heating capacity	Dimension indoor	Dimension panel	Sound pressure	Air flow	Indoor RRP	Panel RRP
		kW	kW	HxWxD mm	HxWxD mm	Hi / Med / Lo dB(A)	Hi / Med / Lo m³/sec	£	£
3.6 kW	S-36PY3E	3.60	3.60	243 x 575 x 575	30 x 625 x 625	34/30/25	0.16/0.12/0.10	768	233
5.0 kW	S-50PY3E	5.00	5.00	243 x 575 x 575	30 x 625 x 625	39/34/27	0.20/0.16/0.11	996	233
6.0 kW	S-60PY3E	6.00	6.00	243 x 575 x 575	30 x 625 x 625	43/37/31	0.23/0.18/0.13	1.005	233



INTERNET CONTROL: Optional.



4 way 90x90 cassette	Indoor unit (panels CZ-KPU3W / CZ-KPU3AW)	Cooling capacity	Heating capacity	Dimension indoor	Dimension panel	Sound pressure	Air flow	Indoor RRP	Panel RRP
		kW	kW	HxWxD mm	HxWxD mm	Hi / Med / Lo dB(A)	Hi / Med / Lo m³/sec	£	£
3.6 / 4.5 / 5.0 kW	S-3650PU3E	3.6 - 5.0	4.0 - 5.6	256 x 840 x 840	33.5 x 950 x 950	30/28/27 ¹⁾	0.24/0.22/0.19 ¹⁾	563	204 / 278
6.0 / 7.1 kW	S-6071PU3E	6.0 - 7.1	7.0 - 8.0	256 x 840 x 840	33.5 x 950 x 950	36/31/28 ¹⁾	0.35/0.27/0.22 ¹⁾	861	204 / 278
10.0 / 12.5 / 14.0 kW	S-1014PU3E	10.0 - 14.0	11.2 - 16.0	319 x 840 x 840	33.5 x 950 x 950	45/38/32 ¹⁾	0.60/0.43/0.30 ¹⁾	2.323	204 / 278



INTERNET CONTROL: Optional.



Ceiling	Indoor unit	Cooling capacity	Heating capacity	Dimension	Sound pressure	Air flow	RRP
		kW	kW	HxWxD mm	Hi / Med / Lo dB(A)	Hi / Med / Lo m³/sec	
3.6 / 4.5 / 5.0 kW	S-3650PT3E	3.5 - 5.0	4.0 - 5.6	235 x 960 x 690	36/32/28 ¹⁾	0.23/0.20/0.18 ¹⁾	845
6.0 / 7.1 kW	S-6071PT3E	6.0 - 6.8	7.0 - 8.0	235 x 1275 x 690	38/34/29 ¹⁾	0.33/0.28/0.24 ¹⁾	1.058
10.0 / 12.5 / 14.0 kW	S-1014PT3E	9.5 - 13.4	11.2 - 16.0	235 x 1590 x 690	42/37/34 ¹⁾	0.50/0.42/0.38 ¹⁾	1.358



INTERNET CONTROL: Optional.



Adaptive ducted unit	Indoor unit	Cooling capacity	Heating capacity	Dimension	External static pressure	Sound pressure	Air flow	RRP
		kW	kW	HxWxD mm	Nominal (Min - Max) Pa	Hi / Med / Lo dB(A)	Hi / Med / Lo m³/sec	
3.6 / 4.5 / 5.0 kW	S-3650PF3E	3.6 - 5.0	4.0 - 5.6	250 x 800 x 730	30 (10 - 150)	30/27/22 ¹⁾	0.23/0.22/0.17 ¹⁾	855
6.0 / 7.1 kW	S-6071PF3E	5.7 - 6.8	7.0 - 7.5	250 x 1000 x 730	30 (10 - 150)	30/26/23 ¹⁾	0.35/0.32/0.25 ¹⁾	1.062
10.0 / 12.5 / 14.0 kW	S-1014PF3E	9.5 - 13.4	10.8 - 13.5	250 x 1400 x 730	30 (10 - 150)	33/29/25 ¹⁾	0.53/0.43/0.35 ¹⁾	1.362

1) 36/60/10 types of indoor units value.

Rating Conditions: Cooling Indoor 27 °C DB / 19 °C WB. Cooling Outdoor 35 °C DB / 24 °C WB. Heating Indoor 20 °C DB. Heating Outdoor 7 °C DB / 6 °C WB. (DB: Dry Bulb; WB: Wet Bulb). Specifications subject to change without notice. For detailed information about ErP / Energy Labelling, please visit our websites www.panasonic.co.uk/aircon or www.ptc.panasonic.eu.



PRO-HT TANK

PRO-HT Tank DHW

High temperature hot water is efficiently produced without any boosters.

Panasonic commercial PRO-HT Tank solutions can be adapted to various projects from high-end residential to gyms, and hotels.

PRO-HT Tank			PAW-VP750LDHW-1	PAW-VP1000LDHW-1
Outdoor unit			U-250PE2E8A	U-250PE2E8A
Power supply	Voltage	V	400	400
	Phase		Three phase	Three phase
	Frequency	Hz	50	50
Volume (net)		L	726	933
Dimension	H x Diameter	mm	1855 x 990	2210 x 990
Net weight / with water		kg	179 / 905	191 / 1124
Connections to the water supply network			RP 1½	RP 1½
Nominal electrical power		W	6670	6670
Reference tapping cycle			2XL	2XL
Energy consumption by chosen cycle [A +7 °C, W 10-55 °C]		kWh	6	6.36
Energy consumption by chosen cycle [A +15 °C, W 10-55 °C]		kWh	5.12	5.12
COP DHW [A +7 °C, W 10-55 °C] EN 16147 ¹⁾			4.1	3.86
COP DHW [A +15 °C, W 10-55 °C] EN 16147 ²⁾			4.79	4.79
Energy Efficiency Class (from A+ to F) ³⁾			A+	A+
Standby input power according to EN16147		W	77	80
Sound pressure on 1m		dB(A)	57	57
Average insulation thickness		mm	100	100
Stainless steel 316 L tank			Yes	Yes
Heat exchanger connection	Inlet	Inch (mm)	1/2 (12.70)	1/2 (12.70)
	Outlet	Inch (mm)	3/4 (19.05)	3/4 (19.05)
Maximum power consumption	Without heater	W	12900	12900
	With heater	W	18900	18900
Number of electrical heaters x power		W	1 x 6000	1 x 6000
Electric protection		A	16	16
Moisture protection			IP24	IP24
Refrigerant (R410A) / CO ₂ Eq.		kg / T	6.4 / 13.363	6.4 / 13.363
Maximum water temperature	Heat pump	°C	65	65
	Electrical heater	°C	85	85
Operating range - outdoor ambient	Heat Min - Max	°C	-20 ~ +24	-20 ~ +24
PRO-HT Tank RRP		£	13.185	13.971
Outdoor unit RRP		£	3.555	3.555

1) Heating of sanitary water up to 55 °C with inlet air temperature at 7 °C, humidity at 89 % and inlet water temperature at 10 °C. According to EN16147. 2) Heating of sanitary water up to 55 °C with inlet air temperature at 15 °C, humidity at 74 % and inlet water temperature at 10 °C. According to EN16147. 3) Scale from A+ to F following COMMISSION DELEGATED REGULATION (EU) No. 812/2013.

This product is designed to comply with the European Water Quality Directive 98/83/EC amended by 2015/1787/EU. The lifespan of the product is not guaranteed in the case of the use of groundwater, such as spring water or well water, the use of tap water when salt or other impurities are contained, nor in areas of acidic water quality. Maintenance and warranty costs related to these cases are the customer's responsibility.

* When connected as pressurised, safety valve is mandatory.

Accessories	RRP £
PAW-VP-RTC5B-PAC Tank controller for PACi system	1.389

Technical focus

- Water volume 750 L and 1000 L
- Maximum hot water production 65 °C without boosters
- Heating coil 52 m (750 L) and 63 m (1000 L)
- Tank material 3 mm
- ABS external case



Solution example DHW tank 1000 L + PACi

- Ideal for small hotels and high-end residential
- Hot water temperature up to 65 °C

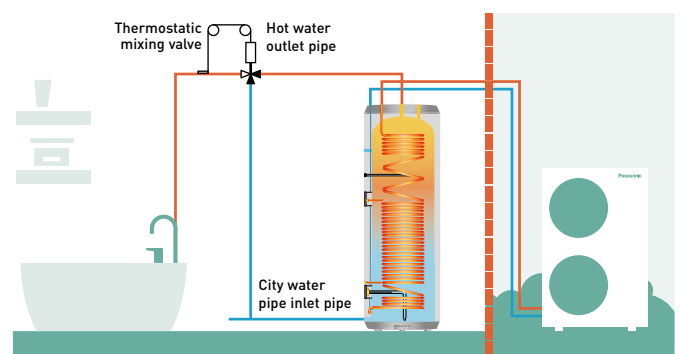



PRO-HT TANK

PRO-HT Tank heating and cooling

High temperature hot water is efficiently produced without any boosters.

Panasonic commercial PRO-HT Tank solutions can be combined with PACi to adapt various projects from high-end residential to small offices.

PRO-HT Tank		PAW-VP380L	
Cooling capacity at 35 °C, water outlet 7 °C	kW	12.80	
Heating capacity	kW	25.00	
Heating capacity at +7 °C, heating water temperature at 45 °C	kW	23.00	
COP at +7 °C, heating water temperature at 45 °C	W/W	3.26	
Heating Energy Efficiency class at 35 °C (from A+++ to D)		A+++	
$\eta_{s,h}$ (LOT1) ¹⁾	%	193	
Dimension	H x Diameter	mm	1820 x 690
Shipping weight		kg	99
Connections to the water supply network			1 1/4"
Heating water flow ($\Delta T=5$ K, 35 °C)		m ³ /h	3.9
Outdoor unit		U-200PZH2E8	
Sound pressure		dB(A)	57
Dimension	H x W x D	mm	1500 x 980 x 370
Net weight		kg	117
Piping diameter	Liquid pipe	Inch (mm)	1/2 (12.07)
	Gas pipe	Inch (mm)	3/4 (19.05)
Pipe length range ²⁾		m	30
Elevation difference (in / out)		m	30 (OD above) 30 (OD below)
Pipe length for nominal capacity		m	7.5
Pipe length for additional gas		m	> 7.5
Additional gas amount		g/m	Refer to manual
Refrigerant (R32) / CO ₂ Eq.		kg	4.20 (1.0kg additional gas charge on site)
Water outlet	Cool Min ~ Max	°C	5 ~ 15
	Heat Min ~ Max	°C	25 ~ 45
Operating range - outdoor ambient	Cool Min ~ Max	°C	-15 ~ +46
	Heat Min ~ Max	°C	-20 ~ +24
PRO-HT Tank RRP		£	6.695
Outdoor unit RRP		£	3.401

1) Seasonal space cooling / heating energy efficiency following COMMISSION REGULATION (EU) 811/2013. 2) The pipe length range is between indoor and outdoor, but does not include additional length for coil.

This product is designed to comply with the European Water Quality Directive 98/83/EC amended by 2015/1787/EU. The lifespan of the product is not guaranteed in the case of the use of groundwater, such as spring water or well water, the use of tap water when salt or other impurities are contained, nor in areas of acidic water quality. Maintenance and warranty costs related to these cases are the customer's responsibility.

Performance calculation in agreement with Eurovent. Sound pressure measured at 1 m from the outdoor unit and at 1.5 m height.

* Flow switch and water filter are not equipped.

Accessories	RRP £
PAW-VP-RTC5B-PAC Tank controller for PACi system	1.389
PAW-IU29 Additional heater	610

Accessories	RRP £
PAW-IU39 Additional heater	792

Technical focus

- Water volume 380 L
- Maximum hot water production 45 °C
- Tank and heat exchanger made with stainless steel
- Heating coil 52 m 316 L
- Internal and external pickling
- Foam insulation 70 mm
- Tank material 2 mm 316 L
- ABS external case

Heating and cooling tank 380 L + PACi 20.0 kW

- Ideal offer for small offices
- Cost saving solution with simple waterborne heating and cooling
- Hot water up to 45 °C

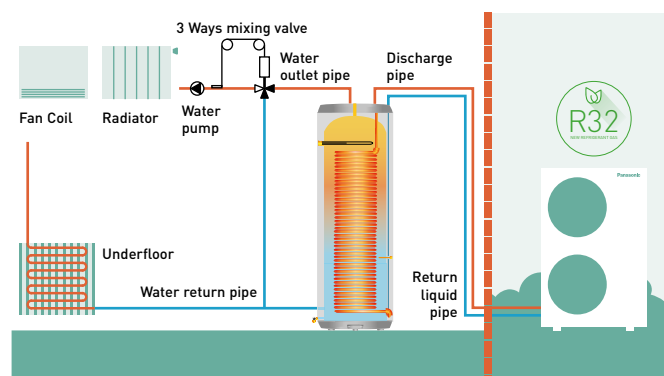

PACi with Water Heat Exchanger

Panasonic introduces a highly-efficient Water Heat Exchanger for PACi Series. This ground-breaking product offers further possibilities of PACi solutions by adding hydronic options.

WATER OUTLET TEMPERATURE
Cooling: 5 ~ 15 °C
Heating: 30 ~ 55 °C



1 Cost saving solution

- A+++ energy efficiency class (scale from A+++ to D)
- Cost effective water projects thanks to lower cost for PACi compared to VRF

2 Space saving and flexible positioning

- 2 installation possibilities (wall-mounted / floor-standing)
- Compact, lightweight unit design, only 27 kg

3 Easy installation, maintenance

- Quick mounting process
- Flow switch kit is included as a standard
- Direct access to electrical box

System example.

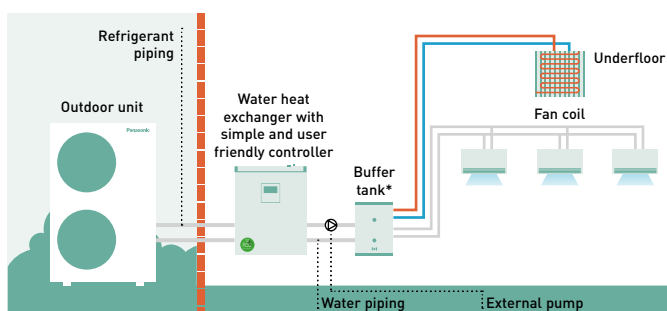

* Minimum buffer tank volume: 10 L/kW. ** Diagram is for illustrative purpose only.

Space saving and flexible positioning

Compact and light unit.

- Only 205 mm depth fits within a limited space
- Lightweight design at only 27 kg, makes it easy to maneuver and position
- Maximum total refrigerant piping length: 90 m*

* 90 m for PAW-200W5APAC.



2 installation options.

- Wall-mounted and floor-standing installation options are available. Free-up floor space by using the wall-mounted installation
 - Quick mounting process with its lightweight compact design
- Make fixing holes → Fix 2 screws → Hang the unit → Finish

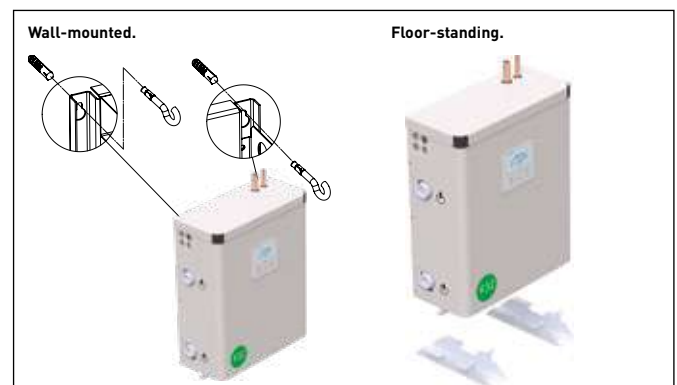



PACi with Water Heat Exchanger for chilled and hot water production

Constant 55 °C flow available.

Short-term investment recovery.

PACi Water Heat Exchanger is ideal for small offices and retails. The investment costs can be amortised within a very short period. This solution allows investors and operators to save money.

			PAW-200W5APAC-1	PAW-250W5APAC-1
Cooling capacity ¹⁾		kW	20.00	25.00
EER ¹⁾		W/W	3.03	2.89
Heating capacity ²⁾		kW	23.00	28.00
COP ²⁾		W/W	2.98	2.95
$\eta_{s,h}$ (LOT1) ³⁾		%	178	178
Energy efficiency class (Scale A+++ to D) ⁴⁾			A+++	A+++
Dimension	H x W x D	mm	550 x 455 x 205	550 x 455 x 205
Net weight		kg	27	27
Water pipe connector		Inch	Male Thread 1 1/4	Male Thread 1 1/4
Cooling water flow ($\Delta T=5$ K, 35 °C)		m ³ /h	3.45	4.30
Heating water flow ($\Delta T=5$ K, 35 °C)		m ³ /h	4.15	4.85
Flow switch			Included	Included
Water filter			Included	Included
Outdoor unit			U-200PZH2E8	U-250PZH2E8
Sound pressure	Cool / Heat (Hi)	dB(A)	59/61	59/63
Dimension	H x W x D	mm	1500 x 980 x 370	1500 x 980 x 370
Net weight		kg	117	128
Piping diameter	Liquid pipe	Inch (mm)	3/8 (9.52)	1/2 (12.70)
	Gas pipe	Inch (mm)	1 (25.40)	1 (25.40)
Pipe length range		m	5 - 90	5 - 60
Elevation difference (in / out)		m	30	30
Pipe length for additional gas		m	30	30
Additional gas amount		g/m	60	80
Water outlet temperature range	Cool Min ~ Max	°C	+5 ~ +15	+5 ~ +15
	Heat Min ~ Max	°C	+30 ~ +55	+30 ~ +55
Operating range	Cool Min ~ Max	°C	-15 ~ +46	-15 ~ +46
	Heat Min ~ Max	°C	-20 ~ +24	-20 ~ +24
Water heat exchanger RRP		£	3.954	4.285
Outdoor unit RRP		£	3.401	3.861

1) Data refers to 7 °C leaving chilled water temperature and 35 °C ambient air temperature, according to EN14511 standard. 2) Data refers to 45 °C leaving warm water temperature and 7 °C ambient air temperature according to EN14511 standard. 3) Following COMMISSION REGULATION (EU) No 813/2013 for low-temperature heat pumps. 4) Following COMMISSION REGULATION (EU) No 811/2013 for low-temperature heat pumps. Scale from A+++ to D.

Professional solution

Water heat exchanger is compatible with R32 PACi. Many air conditioning manufacturers are selling R32 systems and it is becoming the standard refrigerant for split type air conditioning, because R32 has a much lower global warming potential than R410A, and can also provide higher efficiency.



Accessories and control

Drain kits

Drain kit to suit outdoor units from 5.0 to 7.1 kW.

CZ-50DRS1

15 €

Drain kit to suit outdoor units from 10.0 to 25.0 kW.

CZ-140DRS1

23 €

Branch Pipes, Header



Branch pipe.

CZ-P224BK2BM

91 €



Branch pipe (from 22.4 kW to 68 kW).

CZ-P680BK2BM

151 €

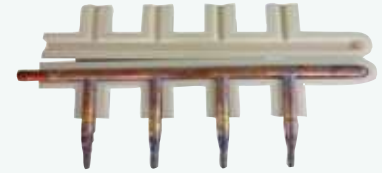

Header.

CZ-P3HPC2BM

129 €

Outdoor accessories



Tray for condenser water compatible with outdoor elevation platform.

PAW-WTRAY

133 €



Outdoor elevation platform.

Dimension (H x W x D): 400 x 900 x 400 mm

PAW-GRDSTD40

133 €



Outdoor base ground support for noise and vibration absorption.

Dimension (H x W x D): 600 x 95 x 130 mm

Safe working load: 500 kg

PAW-GRDBSE20

122 €

Panels



Panel for 4 way 60x60 cassette - PY3.

CZ-KPY4

233 €



Standard panel for 4 way 90x90 cassette.

CZ-KPU3W

204 €



Econavi panel for 4 way 90x90 cassette.

CZ-KPU3AW

278 €



Panel for 60x60 cassette - PY2 size 700x700 mm.

CZ-KPY3AW

233 €

Panel for 60x60 cassette - PY2 size 625x625 mm.

CZ-KPY3BW

224 €

Sensors



Econavi energy savings sensor.

CZ-CENSC1

151 €



Remote temperature sensor.

CZ-CSRC3

108 €

Plenums

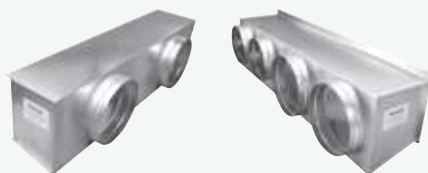

Air outlet plenum for S-3650PF3E.

CZ-56DAF2

172 €

Air outlet plenum for S-1014PF3E.

CZ-160DAF2

242 €

Air outlet plenum for S-200PE2E5.

CZ-TREMIESPW705

692 €

Air outlet plenum for S-6071PF3E.

CZ-90DAF2

211 €

Air outlet plenum for S-250PE2E5.

CZ-TREMIESPW706

731 €

VRF Smart Connectivity+



Remote controller Panasonic Net Con, RH, No PIR, R1/R2.

SER8150R0B1194

517 €

Remote controller Panasonic Net Con, RH, PIR, R1/R2.

SER8150R5B1194

552 €

Wireless ZigBee® Pro module / Green Com card.

VCM8000V5094P

185 €



Hotel Room Expansion Module 14 indoor units.

HRCEP14R

328 €

Hotel Room Controller w/ Display 42 indoor units.

HRCPDG42R

1.113 €



Door / window wireless sensor.

SED-WDC-G-5045

212 €



Wall / ceiling (motion) wireless sensor.

SED-MTH-G-5045

259 €

Hotel Room Controller 28 indoor units.

HRCBPG28R

873 €



CO₂ sensor.

SED-CO2-G-5045

667 €



Sensor with room temperature and humidity.

SED-TRH-G-5045

209 €



Water leakage sensor.

SED-WLS-G-5045

202 €

Accessories and control



Cover frame. Silver.

FAS-00 42 €

Cover frame. Glossy translucent white.

FAS-03 76 €

Cover frame. Dark brown wood.

FAS-06 59 €

Cover frame. Brushed steel finish.

FAS-10 76 €

Cover frame. White.

FAS-01 42 €

Cover frame. Light tan wood.

FAS-05 59 €

Cover frame. Dark black wood.

FAS-07 59 €

Controller and touch controllers for hotels with dry contacts



Modbus RS-485 touch room controller with I/O, white.

PAW-RE2C4-MOD-WH 444 €



Modbus RS-485 touch room controller with I/O, black.

PAW-RE2C4-MOD-BK 444 €

Touch display control with 2 digital inputs, white.

PAW-RE2D4-WH 271 €

Touch display control with 2 digital inputs, black.

PAW-RE2D4-BK 271 €

Hotel sensors for dry contacts



Wall motion sensor 24 V.

PAW-WMS-DC 185 €



Ceiling motion sensor 24 V.

PAW-CMS-DC 185 €



Power supply 24 V.

PAW-24DC 59 €

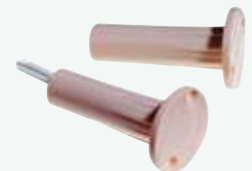

Door or window contact.

PAW-DWC 19 €

Wall motion sensor 240 V AC.

PAW-WMS-AC 185 €

Ceiling motion sensor 240 V AC.

PAW-CMS-AC 185 €

Centralised controls



System controller for 64 indoor units with weekly timer.

CZ-64ESMC3 764 €



Central ON / OFF controller, up to 16 groups, 64 indoor units.

CZ-ANC3 517 €



Intelligent controller (touch screen/web server) to control up to 256 indoors with included load distribution ratio (LDR).

CZ-256ESMC3 2.867 €

Panasonic AC Smart Cloud



Panasonic AC Smart Cloud. Cloud internet control. Up to 128 groups. Controls 128 units.

CZ-CFUSCC1

445 €

Accessories interfaces



Modbus RTU and TCP interface for 16 indoor units.

PAW-AC2-MBS-16P 2.237 €

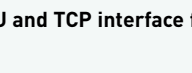

Modbus RTU and TCP interface for 64 indoor units.

PAW-AC2-MBS-64P 3.211 €



Modbus RTU and TCP interface for 128 indoor units.

PAW-AC2-MBS-128P 4.300 €



KNX interface for 16 indoor units.

PAW-AC2-KNX-16P 2.237 €

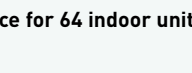

KNX interface for 64 indoor units.

PAW-AC2-KNX-64P 3.211 €



BACnet IP and MSTP interface for 16 indoor units.

PAW-AC2-BAC-16P 2.237 €



BACnet IP and MSTP interface for 64 indoor units.

PAW-AC2-BAC-64P 3.211 €



BACnet IP and MSTP interface for 128 indoor units.

PAW-AC2-BAC-128P 4.300 €



Commercial Wi-Fi Adaptor.

CZ-CAPWFC1 176 €



KNX interface.

PAW-RC2-KNX-1i 347 €



Modbus RTU interface.

PAW-RC2-MBS-1 347 €



Modbus RTU interface to control 4 indoor groups.

PAW-RC2-MBS-4 804 €



BACnet IP and MSTP.

PAW-RC2-BAC-1 574 €



RAC interface adapter for integration into P-Link, plus external input and alarm/status output (for YKEA units).

CZ-CAPRA1 163 €

Accessories and control

Centralised controls. Connection with general equipment



Adaptor for ON / OFF control of external devices.

CZ-CAPC3

328 €



Mini series parallel device controlling indoor units, maximum 1 group and 8 indoor unit.

CZ-CAPBC2

275 €



Communication Adaptor. Up to 128 groups. Controls 128 units.

CZ-CFUNC2

1.205 €

Individual controls



CONEX wired remote controller (non-wireless).

CZ-RTC6

144 €



CONEX wired remote controller with Bluetooth®.

CZ-RTC6BL

172 €



CONEX wired remote controller with Wi-Fi and Bluetooth®.

CZ-RTC6BLW*

242 €



Design wired remote controller with Econavi function and datanavi.

CZ-RTC5B

144 €



Infrared remote controller and receiver for 4 way 90x90 cassette.

CZ-RWS3 + CZ-RWRU3W

276 €



Infrared remote controller and receiver for 4 way 60x60 cassette PY3 with panel.

CZ-RWS3 + CZ-RWRY3

276 €



Infrared remote controller for wall-mounted and 4 way 60x60 cassette with panel.

CZ-RWS3

108 €



Infrared remote controller and receiver for ceiling.

CZ-RWS3 + CZ-RWRT3

276 €





Infrared remote controller and receiver for all indoor units.



CZ-RWS3 + CZ-RWRC3

276 €

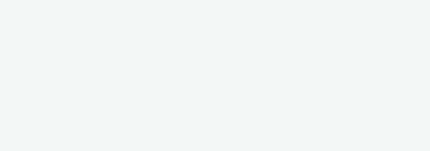
Accessories PCB

		
<p>T10 interface PCB with digital and relay connections.</p>	<p>PCB for server room application, control of 3 PACi units, redundancy, back-up, etc.</p>	<p>Connector to PACi NX indoor unit's PCB to provide OPT functions.</p>
<p>PAW-T10 100 €</p>	<p>PAW-PACR3 1.745 €</p>	<p>PAW-OPT-NX tbc</p>

Accessories cables

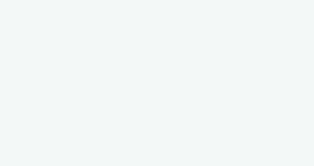
			
<p>Cable for all the T10 functions.</p>	<p>Cable to operate external EC fan.</p>	<p>Cable for all option monitoring signals.</p>	<p>Cable with force thermo OFF/leakage detection.</p>
<p>CZ-T10 47 €</p>	<p>PAW-FDC 47 €</p>	<p>PAW-OCT 47 €</p>	<p>PAW-EXCT 47 €</p>

PRO-HT Tank accessories

<p>Tank controller for PACi system.</p>	<p>Additional heater.</p>	<p>Additional heater.</p>
<p>PAW-VP-RTC5B-PAC 1.389 €</p>	<p>PAW-IU29 610 €</p>	<p>PAW-IU39 792 €</p>

* Only compatible with PACi NX Series.

ECO i EX

ECO i

ECO G



Commercial VRF Systems







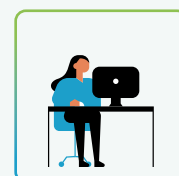









Professional solutions for commercial projects.

Panasonic VRF Systems are specifically designed for energy saving, easy installation and high efficiency performance. A wide range of outdoor and indoor unit models offer unique features which are designed for the most demanding offices and large buildings.

VRF outdoor units range	→ 86	VRF Smart Connectivity+	→ 95
Mini ECOi LZ2 Series R32	→ 88	Slim 3-Pipe control box kit / Multiple connection type	→ 104
Mini ECOi LE Series R410A	→ 92	Bringing nature's balance indoors	→ 120
2-Pipe ECOi EX ME2 Series	→ 96	PRO-HT Tank DHW	→ 136
3-Pipe ECOi EX MF3 Series	→ 102	BMS interface with P-Link	→ 137
Eurovent certified technical data	→ 106	Fan coils	→ 138
2-Pipe ECO G GE3 Series	→ 109	Accessories and control	→ 142
3-Pipe ECO G GF3 Series	→ 111	Dimensions and tube sizes of branches and headers	→ 152
Panasonic GHP/EHP Hybrid System	→ 112		
Water heat exchanger for chilled and hot water production	→ 114		
Leak detection and automatic refrigerant pump down for R410A refrigerant	→ 116		
ECOi and ECO G systems indoor units range	→ 118		
U2 Type 4 way 90x90 cassette · R32 / R410A	→ 121		
Y3 Type 4 way 60x60 cassette · R32 / R410A	→ 122		
Y2 Type 4 way 60x60 cassette · R32 / R410A	→ 123		
L1 Type 2 way cassette · R410A	→ 124		
D1 Type 1 way cassette · R410A	→ 125		
F3 Type variable static pressure adaptive duct · R410A	→ 126		
F2 Type variable static pressure adaptive duct · R410A	→ 127		
M1 Type slim variable static pressure hide-away concealed duct · R32 / R410A	→ 128		
E2 Type high static pressure hide-away · R410A	→ 129		
Heat recovery with DX coil · R410A	→ 130		
T2 Type ceiling · R410A	→ 131		
K2 Type wall-mounted · R32 / R410A	→ 132		
G1 Type floor console · R410A	→ 133		
P1 Type floor-standing · R410A	→ 134		
R1 Type concealed floor-standing · R410A	→ 134		
Hydrokit for ECOi, water at 45 °C · R410A	→ 135		



VRF outdoor units range

Page	Outdoor units	4 HP	5 HP	6 HP	8 HP	10 HP	12 HP
P. 88	 Mini ECOi LZ2 Series · R32						
		U-4LZ2E5 / U-4LZ2E8	U-5LZ2E5 / U-5LZ2E8	U-6LZ2E5 / U-6LZ2E8	U-8LZ2E8	U-10LZ2E8	
P. 92	Mini ECOi LE2 / LE1 Series · R410A						
		U-4LE2E5 / U-4LE2E8	U-5LE2E5 / U-5LE2E8	U-6LE2E5 / U-6LE2E8	U-8LE1E8	U-10LE1E8	
P. 96	2-Pipe ECOi EX ME2 Series · R410A						
					U-8ME2E8	U-10ME2E8	U-12ME2E8
P. 102	3-Pipe ECOi EX MF3 Series · R410A						
					U-8MF3E8	U-10MF3E8	U-12MF3E8
P. 108	2-Pipe ECO G GE3 Series · R410A						
P. 111	3-Pipe ECO G GF3 Series · R410A						
P. 112	GHP/EHP Hybrid System · R410A						

14 HP

16 HP

18 HP

20 HP

25 HP

30 HP



U-14ME2E8



U-16ME2E8



U-18ME2E8



U-20ME2E8



U-14MF3E8



U-16MF3E8



U-16GE3E5



U-20GE3E5



U-25GE3E5



U-30GE3E5



U-16GF3E5



U-20GF3E5



U-25GF3E5



U-20GES3E5 / U-10MES2E8

Mini ECOi LZ2 Series R32

For light commercial and residential use. The most flexible VRF system ever. Meeting the needs of light commercial applications.



1 Low GWP and less refrigerant

The Mini ECOi LZ2 Series utilizes environmentally friendly R32 refrigerant, reducing the total amount of refrigerant by 20 % and more, resulting in lower GWP, reduced by 75 %*.

* As a result of applying R32 while at the same time reducing the total refrigerant amount.

2 Outstanding efficiency at the most challenging ambient conditions

Re-engineered for better performance, the LZ2 series produces extraordinary savings with SEER levels up to 8.50 and SCOP levels up to 5.05 (for 4 HP model). The large range of outdoor units from 12 kW to 28 kW can also work at extreme ambient temperatures, down to -20 °C in heating and up to 52 °C in cooling, providing a very wide range of operating ability.

3 More flexibility for your project

The ECOi LZ2 series provides ease of installation with long piping lengths and small footprints in a lightweight body. A variety of indoor units, supporting Panasonic's optional R32 refrigerant leak detector, increases the flexibility for installers. A wide range of individual and central controllers, the new generation Smart and Service Cloud, as well as apps for end users and installers, provide a fully customizable monitoring and controlling solution.

WIDE OPERATING RANGE

-20 °C in heating to
52 °C in cooling

8.50 | **5.05**
SEER | **SCOP**
EXTRAORDINARY SAVINGS

ECOi LZ2 mini VRF series from 12 to 28 kW

- Improving protection 24/7. Unique indoors with nanoe™ X, hydroxyl radicals contained in water.
- SEER levels up to 8.50 and SCOP levels up to 5.05 (for 4 HP model)
- Low GWP and highly reduced refrigerant volume
- Improved connectivity with CONEX remote controllers and app support, Smart and Service Cloud applications and support for communication protocols for BMS integration
- Wide range of connectable units allowing wide range of installations with and without refrigerant mitigation
- Increased indoor / outdoor capacity ratio up to 150 %
- Quiet mode operation with low capacity drop
- Same Panasonic DNA with Panasonic compressors and precise temperature control thanks to discharge temperature sensors in the indoor units
- Continuous operation at extreme ambient temperatures: -20 °C (heating) to 52 °C (cooling)
- Flexible mitigation measures, with Panasonic R32 refrigerant leak detector / alarm to be installed only when required
- 35 Pa static pressure

**SHORT
HEIGHT
996 mm**



Mini ECOi LZ2 Series 4 to 6 HP · R32

Outstanding efficiency in a compact body and continuous operation even at extreme ambient temperatures.

HP		4 HP	5 HP	6 HP	4 HP	5 HP	6 HP	
Outdoor units		U-4LZ2E5	U-5LZ2E5	U-6LZ2E5	U-4LZ2E8	U-5LZ2E8	U-6LZ2E8	
Power supply	Voltage	V	220 - 230 - 240	220 - 230 - 240	220 - 230 - 240	380 - 400 - 415	380 - 400 - 415	
	Phase		Single phase	Single phase	Single phase	Three phase	Three phase	
	Frequency	Hz	50	50	50	50	50	
Cooling capacity	kW	12.1	14.0	15.5	12.1	14.0	15.5	
EER ¹⁾	W/W	4.53	4.12	3.88	4.53	4.12	3.88	
SEER ²⁾		8.50	8.12	7.71	8.50	8.12	7.71	
$\eta_{s,c}$	%	337.0	321.8	305.4	337.0	321.8	305.4	
Current	A	13.30 - 12.80 - 12.20	16.90 - 16.20 - 15.50	19.60 - 18.70 - 18.00	4.37 - 4.15 - 4.00	5.50 - 5.23 - 5.04	6.44 - 6.12 - 5.89	
Input power	kW	2.67	3.40	4.00	2.67	3.40	4.00	
Heating capacity	kW	12.5	16.0	16.5	12.5	16.0	16.5	
COP ¹⁾	W/W	5.27	4.71	4.42	5.27	4.71	4.42	
SCOP ²⁾		5.05	4.61	4.59	5.05	4.61	4.59	
$\eta_{s,h}$	%	199.0	181.4	180.6	199.0	181.4	180.6	
Current	A	12.00 - 11.40 - 11.00	16.90 - 16.20 - 15.50	18.50 - 17.70 - 17.00	3.91 - 3.71 - 3.58	5.50 - 5.22 - 5.03	6.02 - 5.72 - 5.51	
Input power	kW	2.37	3.40	3.73	2.37	3.40	3.73	
Starting current	A	1.0	1.0	1.0	1.0	1.0	1.0	
Maximum current	A	19.6	23.7	26.5	7.2	9.2	9.9	
Maximum input power	kW	3.92 - 4.10 - 4.28	4.76 - 4.98 - 5.19	5.41 - 5.66 - 5.90	4.40 - 4.63 - 4.80	5.69 - 5.99 - 6.22	6.15 - 6.47 - 6.72	
Maximum number of connectable indoor units ³⁾		7(10)	8(12)	9(12)	7(10)	8(12)	9(12)	
External static pressure	Pa	0 - 35	0 - 35	0 - 35	0 - 35	0 - 35	0 - 35	
Maximum fuse size	A	25	35	35	15	15	15	
Air flow	m ³ /sec	1.15	1.20	1.23	1.15	1.20	1.23	
Sound pressure	Cool	dB(A)	52	53	54	52	53	54
	Cool (Silent 1/2/3/4)	dB(A)	49/47/45/45	50/48/46/45	51/49/47/45	49/47/45/45	50/48/46/45	51/49/47/45
	Heat	dB(A)	54	56	56	54	56	56
Sound power	Cool / Heat	dB(A)	69/72	70/74	72/75	69/72	70/74	72/75
Dimension	H x W x D	mm	996 x 980 x 370	996 x 980 x 370	996 x 980 x 370	996 x 980 x 370	996 x 980 x 370	
Net weight	kg	94	94	94	94	94	94	
Piping diameter	Liquid pipe	Inch (mm)	3/8(9.52)	3/8(9.52)	3/8(9.52)	3/8(9.52)	3/8(9.52)	
	Gas pipe	Inch (mm)	5/8(15.88)	5/8(15.88)	5/8(15.88)	5/8(15.88)	5/8(15.88)	
Maximum piping length (total)	m	90(180)	90(180)	90(180)	90(180)	90(180)	90(180)	
Elevation difference (in / out)	m	50(OD above)/ 40(OD below)	50(OD above)/ 40(OD below)	50(OD above)/ 40(OD below)	50(OD above)/ 40(OD below)	50(OD above)/ 40(OD below)	50(OD above)/ 40(OD below)	
Refrigerant (R32)	kg	2.7	2.7	2.7	2.7	2.7	2.7	
Max. allowable indoor / outdoor capacity ratio ⁴⁾	%	50 - 150(130)	50 - 150(130)	50 - 150(130)	50 - 150(130)	50 - 150(130)	50 - 150(130)	
Operating range	Cool Min ~ Max	°C	-10 ~ 52	-10 ~ 52	-10 ~ 52	-10 ~ 52	-10 ~ 52	
	Heat Min ~ Max	°C	-20 ~ 18	-20 ~ 18	-20 ~ 18	-20 ~ 18	-20 ~ 18	
RRP	£	3.737	4.004	4.438	4.001	4.527	4.872	

1) EER and COP calculation is based on EN 14511. 2) SEER / SCOP is calculated based on the seasonal space cooling / heating efficiency "η" values of the COMMISSION REGULATION (EU) 2016/2281. SEER, SCOP = [η + Correction] × PEF. 3) The number in parenthesis indicates maximum number of connectable indoor unit in case of 1.5kW indoor units connection. 4) The number in parenthesis indicates maximum allowed indoor / outdoor capacity ratio in case of 1.5 kW indoor units connection.

Minimum environmental impact

Panasonic has designed the LZ2 series in order to minimize the environmental impact of the system. Low GWP refrigerant R32 and highest efficiency levels ensure this through the total operational lifetime.

For the most challenging spaces

The Mini ECOi LZ2 R32 VRF system is the ideal solution to fit into any application thanks to its compact design and long piping lengths.

Technical focus

- SEER levels up to 8.50 and SCOP levels up to 5.05 (for 4 HP model)
- Continuous operation at extreme ambient temperatures: -20 °C (heating) to 52 °C (cooling)
- Wide range of connectable units
- Unique indoors with nanoTM X, hydroxyl radicals contained in water
- Allowing wide range of installations with and without mitigation measures
- Flexible mitigation measures, with Panasonic R32 refrigerant leak detector / alarm to be installed only when required



INTERNET CONTROL: Optional.

Rating Conditions: Cooling Indoor 27 °C DB / 19 °C WB. Cooling Outdoor 35 °C DB / 24 °C WB. Heating Indoor 20 °C DB. Heating Outdoor 7 °C DB / 6 °C WB. (DB: Dry Bulb; WB: Wet Bulb). Specifications subject to change without notice. For detailed information about ErP / Energy Labelling, please visit our websites www.panasonic.co.uk/aircon or www.ptc.panasonic.eu.

Mini ECOi LZ2 Series 8 and 10 HP - R32

Introducing widest range of R32 Mini VRF.



**INDUSTRY 1ST
8 HP AND 10 HP
MINI VRF UNITS
WITH R32**

HP			8 HP	10 HP
Outdoor units			U-8LZ2E8	U-10LZ2E8
Power supply	Voltage	V	380 - 400 - 415	380 - 400 - 415
	Phase		Three phase	Three phase
	Frequency	Hz	50	50
Cooling capacity		kW	22.4	28.0
EER ¹⁾		W/W	3.84	3.47
SEER ²⁾			7.56	7.08
$\eta_{s,c}$		%	293.3	274.7
Current		A	9.73 - 9.25 - 8.91	13.2 - 12.5 - 12.1
Input power		kW	5.83	8.07
Heating capacity		kW	25.0	28.0
COP ¹⁾		W/W	4.30	4.47
SCOP ²⁾			4.59	4.60
$\eta_{s,h}$		%	170.3	178.5
Current		A	9.81 - 9.32 - 8.98	10.5 - 9.93 - 9.57
Input power		kW	5.81	6.26
Starting current		A	1.0	1.0
Maximum current		A	13.7	19.5
Maximum input power		kW	8.21 - 8.64 - 8.96	11.9 - 12.6 - 13.0
Maximum number of connectable indoor units ³⁾			16	16
External static pressure		Pa	0 - 35	0 - 35
Maximum fuse size		A	25	30
Air flow		m ³ /sec	2.63	2.78
Sound pressure	Cool	dB(A)	59.0	60.0
	Cool (Silent 1/2/3/4)	dB(A)	56/54/52/50	57/55/53/50
Sound power	Cool	dB(A)	72	74
Dimension	H x W x D	mm	1500 x 980 x 370	1500 x 980 x 370
Net weight	Liquid pipe	Inch (mm)	3/8 (9.52)	3/8 (9.52)
	Gas pipe	Inch (mm)	3/4 (19.05)	7/8 (22.22)
Maximum piping length (total)		m	100 (300)	100 (300)
Elevation difference (in / out)		m	50 (OD above) / 40 (OD below)	50 (OD above) / 40 (OD below)
Refrigerant (R32)		kg	4.9	5.1
Maximum allowable indoor / outdoor capacity ratio ⁴⁾		%	50 - 150 (130)	50 - 150 (130)
Operating range	Cool Min ~ Max	°C	-10 - 52	-10 - 52
	Heat Min ~ Max	°C	-20 - 18	-20 - 18
RRP		£	6.349	6.963

1) EER and COP calculation is based on EN 14511. 2) SEER / SCOP is calculated based on the seasonal space cooling / heating efficiency " η " values of the COMMISSION REGULATION (EU) 2016/2281. SEER, SCOP = $(\eta + \text{Correction}) \times \text{PEF}$. 3) The number in parenthesis indicates maximum number of connectable indoor unit in case of 1.5 kW indoor units connection. 4) The number in parenthesis indicates maximum allowed indoor / outdoor capacity ratio in case of 1.5 kW indoor units connection.

Perfect fit for small to medium size projects

8 and 10 HP LZ2 Mini VRF units bring in the total benefits of a VRF system in a smaller application. You can enjoy advanced individual and central VRF control options including the revolutionary Panasonic AC Smart Cloud and AC Service Cloud.

For the most difficult conditions

ECOi LZ2 series are able to operate at the hardest conditions from -20 °C up to +52 °C providing continuous and efficient, heating and cooling for your space all year long.

Technical focus

- SEER levels up to 7.56 and SCOP levels up to 4.59 (for 8 HP model)
- Continuous operation at extreme ambient temperatures: -20 °C (heating) to 52 °C (cooling)
- Widest range of connectable units in R32 VRF
- Unique indoors with nanoe™ X, hydroxyl radicals contained in water
- Allowing wide range of installations with and without refrigerant mitigation
- Flexible mitigation measures, with Panasonic R32 refrigerant leak detector / alarm to be installed only when required



INTERNET CONTROL: Optional.

Safe usage of R32 in Panasonic Mini VRF systems

R32 being a mildly flammable refrigerant (category A2L), the design and installation of systems operating with R32 must comply with the relevant refrigerant safety regulations. Those regulations which apply to our Mini VRF systems and the unique “incorporated circulation air flow” method are:

1. EN 378 (ISO 5149) for safety and toxicity,
2. IEC 60335-2-40 (ed. 6.0) for safety and flammability.

The restrictions imposed on the refrigerant charges in a system due to the flammability of R32 are more severe than those imposed by toxicity. Therefore, in standard applications using our Mini VRF systems, toxic concentrations cannot occur.

Incorporated circulation airflow – Mitigation method applied by Panasonic

In applications where the refrigerant charge of a system exceeds the limits allowed for a specific room size, Panasonic Mini VRF systems offer the so-called “incorporated circulation air flow method” in combination with an R32 leak detector, which substantially helps considerably to overcome such limitations. As soon as a leak occurs and is detected by the sensor, the detector triggers an alarm, the compressor stops and the indoor unit fan is set to high speed to circulate the air in the room, thus diluting the R32 concentration.



Scaling your control options from a single zone to geographically distributed facilities

LZ2 series are fully compatible with all control and connectivity solutions from Panasonic. With a wide range of individual controllers, hotel room controllers, optional wireless adapters, VRF Smart Connectivity+, easy BMS connection with P-link and Panasonic AC Smart Cloud compatibility. LZ2 series, the most flexible control and monitoring R32 solution in the market.

Panasonic R32 refrigerant leak detector/alarm (optional)

For compatible indoor unit models, Panasonic offers its optional external Panasonic R32 refrigerant leak detector (CZ-CGLSC1). This enables the customer to decide if a Panasonic R32 refrigerant leak detector is required to comply with the restrictions, or if the indoor unit may be safely installed in this room without it. This optional leakage detection sensor has an integrated alarm buzzer and can output a signal to a central alarm system in the building. The device is connected to the remote control terminals of the indoor unit and can be used in combination with any of the Panasonic VRF remote controllers, either wired or wireless.



The alarm triggered by the Panasonic R32 refrigerant leak detector will also be transmitted and displayed on any connected centralised controller.

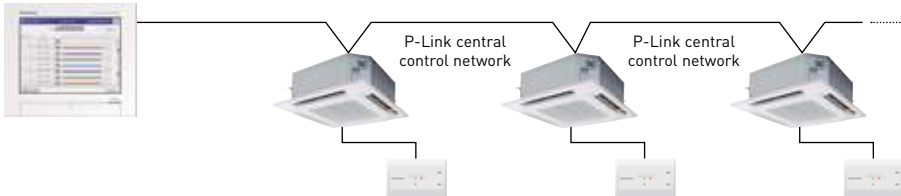

Mini ECOi LE Series R410A

For light commercial and residential use. The most flexible VRF system ever. Meeting the needs of light commercial applications.



1 Efficiency energy control

Upgraded outdoor units deliver high efficiency rating and reduced energy costs.

2 Space saving

Ideal for commercial locations with limited space such as banks and shops. Compact units integrate easily and discreetly into building design.

3 Flexible installation

Reduced installation time thanks to compact units and extra long piping without additional refrigeration charge. High external static pressure 35Pa and small chassis increase installation options.



7.9 | **4.9***
SEER | SCOP
INDUSTRY LEADING EFFICIENCY



6.4*
SEER
4.3
SCOP

Compact design: LE2 Series - 4 / 5 / 6 HP

- Extraordinary energy saving: 7.9 SEER and 4.9 SCOP (4 HP)*
- 50 m piping length without additional refrigerant charge
- Quiet operation mode with 4 levels
- High COP mode option

LE1 Series - 8 / 10 HP

- 60 % smaller than ECOi ME2 8 / 10 HP with vertical flow type
- Flexible piping length (Total: 300 m, Furthest: 150 m)
- Maximum number of connectable indoor units: 15

* SEER / SCOP is calculated based on the seasonal space cooling / heating efficiency "η" values of the COMMISSION REGULATION (EU) 2016/2281. SEER, SCOP = (η + Correction) × PEF.

Key features for LE2 / LE1.

High external static pressure 35Pa — Full range of ECOi indoor units and controllers — Variable evaporation temperature control as standard — Connectable maximum indoor / outdoor capacity ratio up to 130 % — Auto restart from outdoor units — Demand response (Peak cut) by optional parts — Suitable for R22 renewable projects

Mini ECOi LE2 Series High Efficiency 4 to 6 HP - R410A

Panasonic Mini ECOi. Extraordinary energy-saving.
The most compact ECOi system ever.



HP		4 HP	5 HP	6 HP	4 HP	5 HP	6 HP	
Outdoor units		U-4LE2E5	U-5LE2E5	U-6LE2E5	U-4LE2E8	U-5LE2E8	U-6LE2E8	
Power supply	Voltage	V	220 - 230 - 240	220 - 230 - 240	220 - 230 - 240	380 - 400 - 415	380 - 400 - 415	
	Phase		Single phase	Single phase	Single phase	Three phase	Three phase	
	Frequency	Hz	50	50	50	50	50	
Cooling capacity	kW	12.1	14.0	15.5	12.1	14.0	15.5	
EER ¹⁾	W/W	4.50	4.06	3.73	4.50	4.06	3.73	
SEER ²⁾		7.9	7.5	7.3	7.9	7.5	7.3	
$\eta_{s,c}$	%	311.0	296.2	286.8	311.0	296.2	286.8	
Current	A	13.30 - 12.70 - 12.20	16.30 - 15.60 - 17.00	20.30 - 19.40 - 18.60	4.39 - 4.17 - 4.02	5.58 - 5.30 - 5.11	6.71 - 6.37 - 6.14	
Input power	kW	2.69	3.45	4.15	2.69	3.45	4.15	
Heating capacity	kW	12.5	16.0	16.5	12.5	16.0	16.5	
COP ¹⁾	W/W	5.19	4.60	4.27	5.19	4.60	4.27	
SCOP ²⁾		4.9	4.4	4.2	4.9	4.4	4.2	
$\eta_{s,h}$	%	191.8	172.9	166.7	191.8	172.9	166.7	
Current	A	12.20 - 11.60 - 11.20	17.60 - 16.80 - 16.10	19.10 - 18.20 - 17.50	3.98 - 3.78 - 3.64	5.62 - 5.34 - 5.14	6.24 - 5.93 - 5.71	
Input power	kW	2.41	3.48	3.86	2.41	3.48	3.86	
Starting current	A	1.00	1.00	1.00	1.00	1.00	1.00	
Maximum current	A	17.30	24.30	27.40	7.90	10.10	10.70	
Maximum input power	kW	3.50 - 3.66 - 3.82	4.92 - 5.14 - 5.37	5.61 - 5.86 - 6.12	4.34 - 5.09 - 5.28	6.25 - 6.55 - 6.82	6.62 - 6.97 - 7.23	
Maximum number of connectable indoor units ³⁾		7(10)	8(10)	9(12)	7(10)	8(10)	9(12)	
External static pressure	Pa	0 - 35	0 - 35	0 - 35	0 - 35	0 - 35	0 - 35	
Maximum fuse size	A	25	30	35	15	15	15	
Air flow	m ³ /sec	1.15	1.20	1.23	1.15	1.20	1.23	
Sound pressure	Cool	dB(A)	52	53	54	52	53	
	Cool (Silent 1/2/3/4)	dB(A)	50.5/49/47/45	51.5/50/48/46	52.5/51/48/46	50.5/49/49/47	48.5/50/48/46	48.5/50/48/46
	Heat	dB(A)	54	56	56	54	56	56
Sound power	Cool / Heat	dB(A)	69/72	71/75	73/75	69/72	71/75	
Dimension	H x W x D	mm	996 x 980 x 370	996 x 980 x 370	996 x 980 x 370	996 x 980 x 370	996 x 980 x 370	
Net weight	kg	106	106	106	106	106	106	
Piping diameter	Liquid pipe	Inch (mm)	3/8(9.52)	3/8(9.52)	3/8(9.52)	3/8(9.52)	3/8(9.52)	
	Gas pipe	Inch (mm)	5/8(15.88)	5/8(15.88)	5/8(15.88)	5/8(15.88)	5/8(15.88)	
Maximum piping length (total)	m	150(180)	150(180)	150(180)	150(180)	150(180)	150(180)	
Elevation difference (in / out)	m	50(OD above)/ 40(OD below)	50(OD above)/ 40(OD below)	50(OD above)/ 40(OD below)	50(OD above)/ 40(OD below)	50(OD above)/ 40(OD below)	50(OD above)/ 40(OD below)	
Refrigerant (R410A) / CO ₂ Eq.	kg / T	6.70(14.40)/ 13.9896	6.70(14.40)/ 13.9896	6.70(14.40)/ 13.9896	6.70(14.40)/ 13.9896	6.70(14.40)/ 13.9896	6.70(14.40)/ 13.9896	
Max. allowable indoor / outdoor capacity ratio	%	50 ~ 130	50 ~ 130	50 ~ 130	50 ~ 130	50 ~ 130	50 ~ 130	
Operating range	Cool Min ~ Max	°C	-10 ~ +46	-10 ~ +46	-10 ~ +46	-10 ~ +46	-10 ~ +46	
	Heat Min ~ Max	°C	-20 ~ +18	-20 ~ +18	-20 ~ +18	-20 ~ +18	-20 ~ +18	
RRP	£	3.559	3.813	4.227	3.810	4.310	4.640	

1) EER and COP calculation is based in accordance to EN14511. 2) SEER / SCOP is calculated based on the seasonal space cooling / heating efficiency "η" values of the COMMISSION REGULATION (EU) 2016/2281. SEER, SCOP = (η + Correction) × PEF. 3) In case of 1.5 kW indoor units connection, able to connect maximum 12 indoor units.

For light commercial use

Mini ECOi allows easier installation in condominiums and medium sized buildings with limited spaces. Utilising R410A and DC inverter technology, Panasonic offers VRF to a new and growing market.

Reduced height of 996 mm

In addition to raising efficiency, the outdoor unit has been designed to be as compact as possible. It can now be installed in places that were previously too small.



INTERNET CONTROL: Optional.

Technical focus

- Outstanding SEER and SCOP
- Better efficiency even compared to 2 fan outdoor units
- 50 m piping without additional refrigeration charge
- High static pressure 35 Pa
- High COP mode selectable with maintenance remote controller
- Selectable silent mode



Mini ECOi LE1 Series High Efficiency 8 and 10 HP - R410A

Prepare to be blown away by Panasonic's Mini VRF system.

The Mini VRF compact system is the ideal solution for minimum outdoor space. Panasonic extends the Mini VRF range by 8 and 10 HP units.



HP			8 HP	10 HP
Outdoor units			U-8LE1E8	U-10LE1E8
Power supply	Voltage	V	380 - 400 - 415	380 - 400 - 415
	Phase		Three phase	Three phase
	Frequency	Hz	50	50
Cooling capacity		kW	22.4	28.0
EER ¹⁾		W/W	3.80	3.11
SEER ²⁾			6.3	6.4
$\eta_{s,c}$		%	247.9	251.8
Current		A	9.60 - 9.15 - 8.80	14.70 - 14.00 - 13.50
Input power		kW	5.89	9.00
Heating capacity		kW	25.0	28.0
COP ¹⁾		W/W	4.02	3.93
SCOP ²⁾			4.2	4.3
$\eta_{s,h}$		%	166.4	169.5
Current		A	10.20 - 9.65 - 9.30	11.60 - 11.10 - 10.70
Input power		kW	6.22	7.13
Starting current		A	1.00	1.00
Maximum current		A	13.70	19.60
Maximum input power		kW	9.16	13.10
Maximum number of connectable indoor units ³⁾			15	15
External static pressure		Pa	0 - 35	0 - 35
Maximum fuse size		A	25	30
Air flow		m ³ /sec	2.50	2.67
Sound pressure	Cool	dB(A)	60	63
	Cool (Silent 1/2/3)	dB(A)	57/55/53	60/58/56
	Heat	dB(A)	64	65
Sound power	Cool / Heat	dB(A)	81/85	84/86
Dimension	H x W x D	mm	1500 x 980 x 370	1500 x 980 x 370
Net weight		kg	132	133
Piping diameter	Liquid pipe	Inch (mm)	3/8 (9.52) ⁴⁾ / 1/2 (12.70) ⁵⁾	3/8 (9.52) ⁴⁾ / 1/2 (12.70) ⁵⁾
	Gas pipe	Inch (mm)	3/4 (19.05) ⁴⁾ / 7/8 (22.22) ⁵⁾	7/8 (22.22) ⁴⁾ / 1 (25.40) ⁵⁾
Maximum piping length (total)		m	7.5 - 150 (7.5 - 300)	7.5 - 150 (7.5 - 300)
Elevation difference (in / out)		m	50 (OD above) / 40 (OD below)	50 (OD above) / 40 (OD below)
Refrigerant (R410A) / CO ₂ Eq.		kg / T	6.30 (24.00) / 13.1544	6.60 (24.00) / 13.7808
Maximum allowable indoor / outdoor capacity ratio		%	50 - 130	50 - 130
Operating range	Cool Min ~ Max	°C	-10 ~ +46	-10 ~ +46
	Heat Min ~ Max	°C	-20 ~ +18	-20 ~ +18
RRP		£	6.046	6.631

1) EER and COP calculation is based in accordance to EN14511. 2) SEER / SCOP is calculated based on the seasonal space cooling / heating efficiency "η" values of the COMMISSION REGULATION (EU) 2016/2281. SEER, SCOP = (η + Correction) × PEF. 3) If the heating utilized, it is necessary to increase 1 size with respect to the main liquid pipe, depending on the combination of the indoor unit. 4) Under 90 m for ultimate indoor unit. 5) Over 90 m for ultimate indoor unit. If the longest piping equivalent length exceeds 90 m, increase the sizes of the main tubes by 1 rank for gas and liquid pipes.

Increase external static pressure

When unit is installed on a narrow balcony, the fence at front side will be the obstacle. High external static pressure will overcome this obstacle and maintain operation capacity.

High ambient temperature performance

Cooling operating range up to 46 °C. The system can maintain the rated (100 %) capacity up to 40 °C by 8 HP model and up to 37 °C by 10 HP model.

Technical focus

- Piping flexibility with 150 m maximum length
- High efficiency
- Connection of up to 15 indoor units
- Quiet operation mode (one of the lowest in the market)
- High ambient temp performance
- High static pressure 35 Pa



INTERNET CONTROL: Optional.



VRF Smart Connectivity+

The future of Control.

VRF Smart Connectivity+ offers efficient energy management and a new air conditioning control solution with high IAQ (Indoor Air Quality).



Energy Management System for Rooms	Each room is monitored by high-precision sensors, making it possible to make every room's temperature comfortable without wasting energy.
Management System for the Entire Building	A Building Energy Management System (BEMS) can also be connected for Plug & Play centralised control of the building's entire energy consumption.

Connect to the future. VRF Smart Connectivity+

Through thorough energy management, Panasonic's VRF Smart Connectivity+ is a completely new, state-of-the-art solution providing energy saving and comfort as well as simple installation, operation and running.

Panasonic, passionately pursuing the ultimate in energy saving through the application of cutting-edge technology, and Schneider Electric, an advanced global energy management specialist offering innovative control systems. This collaboration has set the new standard for creating the next generation of contemporary buildings.

Smart connectivity devices

	Door / window sensor. SED-WDC-G-5045		Wall / ceiling motion / temperature / humidity sensor. SED-MTH-G-5045
	CO₂ temperature / humidity sensor. SED-C02-G-5045		Water leakage sensor. SED-WLS-G-5045

ZigBee communication card VCM

* With optional VCM communication card.

Schneider Electric brand - SE8000

Features

- Up to 5-year battery life batteries included
- Battery life of CO₂ sensor up to 10-year.
- Battery level is a data point
- Sensor points visible when SE8000 is integrated via BACnet MS / TP
- Sensor status and battery level visible when SE8150 is integrated via ZigBee® Pro
- Integration to BMS only recommended when each MPM is connected to Ethernet and set as a ZigBee® Coordinator node

2-Pipe ECOi EX ME2 Series



Energy saving performance, powerful operation, reliability and comfort surpassing anything previously possible.



1 High performance at extreme conditions

ECOi EX is highly reliable, with strong cooling and heating power, even when operating at extreme ambient temperatures. The units can operate at 100 % of capacity at 43 °C, reaching a great cooling operation up to 52 °C and in heating to -25 °C*. Also, the ECOi EX features include Bluefin in newly designed heat exchanger, improving efficiency in marine ambient. A silicone coated PCB (Printed Circuit Board) protects the unit from being damaged by environmental factors such as moisture and dust.

* Conditions of 2-Pipe ECOi EX ME2 Series.

2 Outstanding efficiency and comfort

The ECOi EX system is designed to increase energy efficiency by delivering high SEER rating, as well as high efficiency for part-load operation. The system has reduced energy costs thanks to "All-Inverter Compressors" with independent control, to deliver highly flexible performance. Also, the ECOi EX features an enlarged heat exchanger with triple surfaces that allow for improved heat transfer and a newly designed curved air discharge bell-mouth, for better aerodynamics. The three-stage oil recovery design makes it able to minimise the frequency of forced oil recovery, leading to reduced energy costs and sustained comfort.

3 Superior flexibility

With up to 1000* meters of pipeline, 30 meters maximum height difference between indoor units and maximum 90 meters between outdoor unit and indoor unit, the design possibilities have grown exponentially, making the ECOi EX the ideal air conditioning option for expansive buildings, such as train stations, airports, schools or hospitals. These advantages are enhanced with the wide range of indoor unit models and capacities, facilitating the perfect adaptation to all kind of projects. The careful selection of controls and peripherals such as the Pump Down, the AHU and / or the chiller, enables an optimised system selection. Maximum allowable indoor / outdoor connected capacity ratio of up to 200 %.

* Conditions of 2-Pipe ECOi EX ME2 Series.

Remarkable improvement on key components: extraordinary energy saving performance and redesigned for smooth and better air discharge.



Enlarged heat exchanger surface area with triple surface.



Multiple large-capacity all inverter compressors (from 14 HP).



Newly designed curved air discharge bell mouth for better aerodynamics.

* For 8 and 10 HP unit, the heat exchanger is 2 row design.

VRF with outstanding energy saving performance and powerful operation SEER 7.70 (18 HP model).



2-Pipe ECOi EX ME2 Series

A VRF system delivering energy-saving performance, powerful operation, reliability and comfort, surpassing anything previously possible. It represents a true paradigm shift in air conditioning solutions.

VRF with outstanding energy-saving performance and powerful operation SEER 7.70 (18 HP model).

			8 HP	10 HP	12 HP	14 HP	16 HP	18 HP	20 HP
Outdoor units			U-8ME2E8	U-10ME2E8	U-12ME2E8	U-14ME2E8	U-16ME2E8	U-18ME2E8	U-20ME2E8
Power supply	Voltage	V	380-400-415	380-400-415	380-400-415	380-400-415	380-400-415	380-400-415	380-400-415
	Phase		Three phase	Three phase	Three phase	Three phase	Three phase	Three phase	Three phase
	Frequency	Hz	50	50	50	50	50	50	50
Cooling capacity		kW	22.4	28.0	33.5	40.0	45.0	50.0	56.0
EER ¹⁾		W/W	4.70	4.37	3.96	3.88	3.52	3.52	3.35
ESEER		W/W	9.33	8.67	7.94	7.73	7.19	6.95	6.18
SEER²⁾			7.58	7.09	6.86	7.36	6.55	7.70	7.16
$\eta_{s,c}$		%	294.3	275.4	266.6	286.0	254.3	299.2	278.2
Current		A	7.79-7.40-7.14	10.70-10.20-9.80	13.70-13.00-12.50	17.40-16.50-15.90	21.10-20.10-19.40	23.20-22.00-21.20	26.70-25.40-24.50
Input power		kW	4.77	6.41	8.47	10.30	12.80	14.20	16.70
Heating capacity		kW	25.0	31.5	37.5	45.0	50.0	56.0	63.0
COP ¹⁾		W/W	5.13	4.76	4.73	4.56	4.42	4.38	3.94
SCOP²⁾			4.85	4.32	4.78	4.33	4.09	4.34	4.13
$\eta_{s,h}$		%	188.4	167.6	185.8	168.2	159.0	168.7	160.4
Current		A	7.96-7.56-7.29	11.10-10.50-10.10	12.90-12.30-11.80	16.60-15.80-15.20	18.90-17.90-17.30	21.10-20.10-19.40	25.90-24.60-23.70
Input power		kW	4.87	6.62	7.92	9.86	11.30	12.80	16.00
Starting current		A	1.00	1.00	1.00	2.00	2.00	2.00	2.00
External static pressure (Max)		Pa	80	80	80	80	80	80	80
Maximum fuse size		A	20	25	30	35	40	50	60
Air flow		m ³ /sec	3.73	3.73	3.87	3.87	3.87	6.75	6.75
Sound pressure	Normal mode	dB(A)	54	56	59	60	61	59	60
	Silent mode	dB(A)	51	53	56	57	58	56	57
Sound power	Normal mode	dB(A)	75	77	80	81	82	80	81
Dimension	H x W x D	mm	1842 x 770 x 1000	1842 x 770 x 1000	1842 x 1180 x 1000	1842 x 1180 x 1000	1842 x 1180 x 1000	1842 x 1540 x 1000	1842 x 1540 x 1000
Net weight		kg	210	210	270	315	315	375	375
Piping diameter ³⁾	Liquid pipe	Inch (mm)	3/8(9.52)/ 1/2(12.70)	3/8(9.52)/ 1/2(12.70)	1/2(12.70)/ 5/8(15.88)	1/2(12.70)/ 5/8(15.88)	1/2(12.70)/ 5/8(15.88)	5/8(15.88)/ 3/4(19.05)	5/8(15.88)/ 3/4(19.05)
	Gas pipe	Inch (mm)	3/4(19.05)/ 7/8(22.22)	7/8(22.22)/ 1(25.40)	1(25.40)/ 1-1/8(28.58)	1(25.40)/ 1-1/8(28.58)	1-1/8(28.58)/ 1-1/4(31.75)	1-1/8(28.58)/ 1-1/4(31.75)	1-1/8(28.58)/ 1-1/4(31.75)
	Balance pipe	Inch (mm)	1/4(6.35)	1/4(6.35)	1/4(6.35)	1/4(6.35)	1/4(6.35)	1/4(6.35)	1/4(6.35)
Refrigerant (R410A) / CO ₂ Eq		kg/T	5.60/11.6928	5.60/11.6928	8.30/17.3304	8.30/17.3304	8.30/17.3304	9.50/19.836	9.50/19.836
Maximum allowable indoor / outdoor capacity ratio % ⁴⁾			50 ~ 130(200)	50 ~ 130(200)	50 ~ 130(200)	50 ~ 130(200)	50 ~ 130(200)	50 ~ 130(200)	50 ~ 130(200)
Operating range	Cool Min ~ Max	°C	-10 ~ +52	-10 ~ +52	-10 ~ +52	-10 ~ +52	-10 ~ +52	-10 ~ +52	-10 ~ +52
	Heat Min ~ Max	°C	-25 ~ +18	-25 ~ +18	-25 ~ +18	-25 ~ +18	-25 ~ +18	-25 ~ +18	-25 ~ +18
RRP		£	7.708	8.275	9.915	11.171	12.071	13.865	14.567

1) EER and COP calculation is based in accordance to EN14511. 2) SEER / SCOP is calculated based on the seasonal space cooling / heating efficiency "η" values of the COMMISSION REGULATION (EU) 2016/2281. SEER, SCOP = (η + Correction) × PEF. 3) Piping diameter under 90 m for ultimate indoor unit / over 90 m for ultimate indoor unit (if the longest piping equivalent length exceeds 90 m, increase the sizes of the main tubes by 1 rank for gas tubes and liquid tubes). 4) If the following conditions are satisfied, the effective range is above 130 % and below 200 %: A. Obey the limited number of connectable indoor units. B. The lower limit of operating range for heating outdoor temperature is limited to -10 °C WB (standard -25 °C WB). C. Simultaneous operation is limited to less than 130 % of connectable indoor units.

Technical focus

- Twin rotary inverter compressor
- High performance at extreme conditions
- Outstanding efficiency and comfort
- Extraordinary partial load, SEER and SCOP
- SEER and SCOP following EN-14825
- Oil recovery intelligent control
- Top comfort
- Superior flexibility
- Bluefin full line up EX
- Extremely high capacity at -20 °C and unique heating capacity at -25 °C
- Smooth exhaust flow by new bell-mouth



2-Pipe ECOi EX ME2 Series High Efficiency model combination from 18 to 64 HP

Model name	18 HP		20 HP		22 HP		24 HP		26 HP		28 HP			
	U-8ME2E8		U-10ME2E8		U-10ME2E8		U-12ME2E8		U-10ME2E8		U-12ME2E8			
		U-10ME2E8		U-10ME2E8		U-12ME2E8		U-12ME2E8		U-16ME2E8		U-16ME2E8		
Power supply	Voltage	V	380-400-415		380-400-415		380-400-415		380-400-415		380-400-415		380-400-415	
	Phase		Three phase		Three phase		Three phase		Three phase		Three phase		Three phase	
	Frequency	Hz	50		50		50		50		50		50	
Cooling capacity	kW	50.0		56.0		61.5		68.0		73.0		78.5		
EER ¹⁾	W/W	4.55		4.38		4.13		3.93		3.80		3.69		
Current	A	18.20-17.30-16.60		21.40-20.30-19.60		24.30-23.10-22.30		28.00-26.60-25.60		31.70-30.10-29.00		34.80-33.10-31.90		
Input power	kW	11.00		12.80		14.90		17.30		19.20		21.30		
Heating capacity	kW	56.0		63.0		69.0		76.5		81.5		87.5		
COP ¹⁾	W/W	4.96		4.77		4.76		4.69		4.55		4.56		
Current	A	18.70-17.70-17.10		22.00-20.90-20.20		23.90-22.70-21.90		26.60-25.30-24.40		29.90-28.40-27.40		31.70-30.10-29.00		
Input power	kW	11.30		13.20		14.50		16.30		17.90		19.20		
Starting current	A	2.00		2.00		2.00		2.00		3.00		3.00		
External static pressure (Max)	Pa	80		80		80		80		80		80		
Maximum fuse size	A	20/25		25/25		25/30		30/30		25/40		30/40		
Air flow	m ³ /sec	7.47		7.47		7.60		7.73		7.60		7.73		
Sound pressure	Normal	dB(A)	58.50		59.00		61.00		62.00		62.50		63.50	
	Silent mode	dB(A)	55.50		56.00		58.00		59.00		59.50		60.50	
Sound power	Normal mode	dB(A)	79.50		80.00		82.00		83.00		83.50		84.50	
Dimension / Net weight	HxWxD	mm / kg	1842x1600 x1000/420		1842x1600 x1000/420		1842x2010 x1000/480		1842x2420 x1000/540		1842x2010 x1000/535		1842x2420 x1000/585	
	Liquid pipe	Inch (mm)	5/8(15.88)/ 3/4(19.05)		5/8(15.88)/ 3/4(19.05)		5/8(15.88)/ 3/4(19.05)		5/8(15.88)/ 3/4(19.05)		3/4(19.05)/ 7/8(22.22)		3/4(19.05)/ 7/8(22.22)	
Piping diameter ²⁾	Gas pipe	Inch (mm)	1-1/8(28.58)/ 1-1/4(31.75)		1-1/8(28.58)/ 1-1/4(31.75)		1-1/8(28.58)/ 1-1/4(31.75)		1-1/8(28.58)/ 1-1/4(31.75)		1-1/4(31.75)/ 1-1/2(38.10)		1-1/4(31.75)/ 1-1/2(38.10)	
	Balance pipe	Inch (mm)	1/4(6.35)		1/4(6.35)		1/4(6.35)		1/4(6.35)		1/4(6.35)		1/4(6.35)	
Refrigerant (R410A) / CO ₂ Eq.	kg / T	11.20/23.3856		11.20/23.3856		13.90/29.0232		16.60/34.6608		13.90/29.0232		16.60/34.6608		
Maximum allowable indoor / outdoor capacity ratio % ³⁾		50 ~ 130[200]		50 ~ 130[200]		50 ~ 130[200]		50 ~ 130[200]		50 ~ 130[200]		50 ~ 130[200]		
Operating range	Cool Min ~ Max	°C	-10 ~ +52		-10 ~ +52		-10 ~ +52		-10 ~ +52		-10 ~ +52		-10 ~ +52	
	Heat Min ~ Max	°C	-25 ~ +18		-25 ~ +18		-25 ~ +18		-25 ~ +18		-25 ~ +18		-25 ~ +18	
RRP	£	15.983		16.550		18.190		19.830		20.346		21.986		

Model name	30 HP		32 HP		34 HP		36 HP		38 HP		40 HP			
	U-14ME2E8		U-16ME2E8		U-10ME2E8		U-12ME2E8		U-10ME2E8		U-12ME2E8			
		U-16ME2E8		U-16ME2E8		U-12ME2E8		U-12ME2E8		U-16ME2E8		U-16ME2E8		
Power supply	Voltage	V	380-400-415		380-400-415		380-400-415		380-400-415		380-400-415		380-400-415	
	Phase		Three phase		Three phase		Three phase		Three phase		Three phase		Three phase	
	Frequency	Hz	50		50		50		50		50		50	
Cooling capacity	kW	85.0		90.0		96.0		101.0		107.0		113.0		
EER ¹⁾	W/W	3.68		3.52		4.05		3.95		3.84		3.75		
Current	A	38.60-36.60-35.30		42.30-40.20-38.70		38.70-36.80-35.50		41.40-39.30-37.90		46.10-43.80-42.20		49.20-46.70-45.00		
Input power	kW	23.10		25.60		23.70		25.60		27.90		30.10		
Heating capacity	kW	95.0		100.0		108.0		113.0		119.0		127.0		
COP ¹⁾	W/W	4.48		4.42		4.72		4.73		4.61		4.57		
Current	A	35.40-33.60-32.40		37.70-35.80-34.60		37.80-35.90-34.60		39.00-37.10-35.80		42.60-40.50-39.00		45.90-43.60-42.00		
Input power	kW	21.20		22.60		22.90		23.90		25.80		27.80		
Starting current	A	4.00		4.00		3.00		3.00		4.00		4.00		
External static pressure (Max)	Pa	80		80		80		80		80		80		
Maximum fuse size	A	35/40		40/40		25/30/30		30/30/30		25/30/40		30/30/40		
Air flow	m ³ /sec	7.73		7.73		11.47		11.60		11.47		11.60		
Sound pressure	Normal	dB(A)	63.50		64.00		63.00		64.00		64.00		64.50	
	Silent mode	dB(A)	60.50		61.00		60.00		61.00		61.00		61.50	
Sound power	Normal mode	dB(A)	84.50		85.00		84.00		85.00		85.00		85.50	
Dimension / Net weight	HxWxD	mm / kg	1842x2420 x1000/630		1842x2420 x1000/630		1842x3250 x1000/750		1842x3660 x1000/810		1842x3250 x1000/795		1842x3660 x1000/855	
	Liquid pipe	Inch (mm)	3/4(19.05)/ 7/8(22.22)		3/4(19.05)/ 7/8(22.22)		3/4(19.05)/ 7/8(22.22)		3/4(19.05)/ 7/8(22.22)		3/4(19.05)/ 7/8(22.22)		3/4(19.05)/ 7/8(22.22)	
Piping diameter ²⁾	Gas pipe	Inch (mm)	1-1/4(31.75)/ 1-1/2(38.10)		1-1/4(31.75)/ 1-1/2(38.10)		1-1/4(31.75)/ 1-1/2(38.10)		1-1/2(38.10)/ 1-5/8(41.28)		1-1/2(38.10)/ 1-5/8(41.28)		1-1/2(38.10)/ 1-5/8(41.28)	
	Balance pipe	Inch (mm)	1/4(6.35)		1/4(6.35)		1/4(6.35)		1/4(6.35)		1/4(6.35)		1/4(6.35)	
Refrigerant (R410A) / CO ₂ Eq.	kg / T	16.60/34.6608		16.60/34.6608		22.20/46.3536		24.90/51.9912		22.20/46.3536		24.90/46.3536		
Maximum allowable indoor / outdoor capacity ratio % ³⁾		50 ~ 130[200]		50 ~ 130[200]		50 ~ 130[200]		50 ~ 130[200]		50 ~ 130[200]		50 ~ 130[200]		
Operating range	Cool Min ~ Max	°C	-10 ~ +52		-10 ~ +52		-10 ~ +52		-10 ~ +52		-10 ~ +52		-10 ~ +52	
	Heat Min ~ Max	°C	-25 ~ +18		-25 ~ +18		-25 ~ +18		-25 ~ +18		-25 ~ +18		-25 ~ +18	
RRP	£	23.242		24.142		28.105		29.745		30.261		31.901		

Data is for reference. 1) EER and COP calculation is based in accordance to EN14511. 2) Piping diameter under 90 m for ultimate indoor unit / over 90 m for ultimate indoor unit (if the longest piping equivalent length exceeds 90 m, increase the sizes of the main tubes by 1 rank for gas tubes and liquid tubes). 3) If the following conditions are satisfied, the effective range is above 130 % and below 200 %: A. Obey the limited number of connectable indoor units. B. The lower limit of operating range for heating outdoor temperature is limited to -10 °C WB (standard -25 °C WB). C. Simultaneous operation is limited to less than 130 % of connectable indoor units.

Model name			42 HP	44 HP	46 HP	48 HP	50 HP	52 HP
			U-10ME2E8	U-12ME2E8	U-14ME2E8	U-16ME2E8	U-10ME2E8	U-12ME2E8
			U-16ME2E8	U-16ME2E8	U-16ME2E8	U-16ME2E8	U-12ME2E8	U-12ME2E8
			U-16ME2E8	U-16ME2E8	U-16ME2E8	U-16ME2E8	U-12ME2E8	U-16ME2E8
Power supply	Voltage	V	380-400-415	380-400-415	380-400-415	380-400-415	380-400-415	380-400-415
	Phase		Three phase	Three phase	Three phase	Three phase	Three phase	Three phase
	Frequency	Hz	50	50	50	50	50	50
Cooling capacity		kW	118.0	124.0	130.0	135.0	140.0	145.0
EER ¹⁾		W/W	3.69	3.62	3.62	3.52	3.87	3.82
Current		A	52.80-50.20-48.40	56.00-53.20-51.30	59.90-56.90-54.90	63.40-60.20-58.10	59.10-56.20-54.20	62.10-59.00-56.80
Input power		kW	32.00	34.30	35.90	38.40	36.20	38.00
Heating capacity		kW	132.0	138.0	145.0	150.0	155.0	160.0
COP ¹⁾		W/W	4.49	4.50	4.46	4.42	4.65	4.66
Current		A	49.10-46.60-44.90	50.70-48.20-46.40	54.30-51.50-49.70	56.60-53.80-51.80	55.00-52.20-50.40	56.60-53.80-51.90
Input power		kW	29.40	30.70	32.50	33.90	33.30	34.30
Starting current		A	5.00	5.00	6.00	6.00	5.00	5.00
External static pressure (Max)		Pa	80	80	80	80	80	80
Maximum fuse size		A	25/40/40	30/40/40	35/40/40	40/40/40	25/30/30/40	30/30/30/40
Air flow		m ³ /sec	11.47	11.60	11.60	11.60	15.33	15.47
Sound pressure	Normal	dB(A)	65.00	65.50	65.50	66.00	65.50	66.00
	Silent mode	dB(A)	62.00	62.50	62.50	63.00	62.50	63.00
Sound power	Normal mode	dB(A)	86.00	86.50	86.50	87.00	86.50	87.00
Dimension / Net weight	H x W x D	mm / kg	1842 x 3250 x 1000 / 840	1842 x 3660 x 1000 / 900	1842 x 3660 x 1000 / 945	1842 x 3660 x 1000 / 945	1842 x 4490 x 1000 / 1065	1842 x 4900 x 1000 / 1125
	Liquid pipe	Inch (mm)	3/4(19.05)/7/8(22.22)	3/4(19.05)/7/8(22.22)	3/4(19.05)/7/8(22.22)	3/4(19.05)/7/8(22.22)	3/4(19.05)/7/8(22.22)	3/4(19.05)/7/8(22.22)
Piping diameter ²⁾	Gas pipe	Inch (mm)	1-1/2(38.10)/1-5/8(41.28)	1-1/2(38.10)/1-5/8(41.28)	1-1/2(38.10)/1-5/8(41.28)	1-1/2(38.10)/1-5/8(41.28)	1-1/2(38.10)/1-5/8(41.28)	1-1/2(38.10)/1-5/8(41.28)
	Balance pipe	Inch (mm)	1/4(6.35)	1/4(6.35)	1/4(6.35)	1/4(6.35)	1/4(6.35)	1/4(6.35)
Refrigerant (R410A) / CO ₂ Eq.		kg / T	22.20/51.9912	24.90/51.9912	24.90/51.9912	24.90/51.9912	30.50/63.6840	33.20/69.3216
Maximum allowable indoor / outdoor capacity ratio % ³⁾			50 ~ 130(200)	50 ~ 130(200)	50 ~ 130(200)	50 ~ 130(200)	50 ~ 130(200)	50 ~ 130(200)
Operating range	Cool Min ~ Max	°C	-10 ~ +52	-10 ~ +52	-10 ~ +52	-10 ~ +52	-10 ~ +52	-10 ~ +52
	Heat Min ~ Max	°C	-25 ~ +18	-25 ~ +18	-25 ~ +18	-25 ~ +18	-25 ~ +18	-25 ~ +18
RRP		£	32.417	34.057	35.313	36.213	40.176	41.816

Model name			54 HP	56 HP	58 HP	60 HP	62 HP	64 HP
			U-10ME2E8	U-12ME2E8	U-10ME2E8	U-12ME2E8	U-14ME2E8	U-16ME2E8
			U-12ME2E8	U-12ME2E8	U-16ME2E8	U-16ME2E8	U-16ME2E8	U-16ME2E8
			U-16ME2E8	U-16ME2E8	U-16ME2E8	U-16ME2E8	U-16ME2E8	U-16ME2E8
			U-16ME2E8	U-16ME2E8	U-16ME2E8	U-16ME2E8	U-16ME2E8	U-16ME2E8
Power supply	Voltage	V	380-400-415	380-400-415	380-400-415	380-400-415	380-400-415	380-400-415
	Phase		Three phase	Three phase	Three phase	Three phase	Three phase	Three phase
	Frequency	Hz	50	50	50	50	50	50
Cooling capacity		kW	151.0	156.0	162.0	168.0	174.0	180.0
EER ¹⁾		W/W	3.75	3.71	3.65	3.60	3.60	3.52
Current		A	66.60-63.20-60.90	68.80-65.30-63.00	73.30-69.70-67.10	77.10-73.30-70.60	79.80-75.80-73.00	84.60-80.30-77.40
Input power		kW	40.30	42.10	44.40	46.70	48.30	51.20
Heating capacity		kW	169.0	175.0	182.0	189.0	195.0	201.0
COP ¹⁾		W/W	4.56	4.56	4.47	4.47	4.45	4.42
Current		A	61.90-58.80-56.70	63.40-60.20-58.10	68.00-64.60-62.20	70.60-67.10-64.70	73.10-69.50-67.00	76.00-72.20-69.60
Input power		kW	37.10	38.40	40.70	42.30	43.80	45.50
Starting current		A	6.00	6.00	7.00	7.00	8.00	8.00
External static pressure (Max)		Pa	80	80	80	80	80	80
Maximum fuse size		A	25/30/40/40	30/30/40/40	25/40/40/40	30/40/40/40	35/40/40/40	40/40/40/40
Air flow		m ³ /sec	15.33	15.47	15.33	15.47	15.47	15.47
Sound pressure	Normal	dB(A)	66.00	66.50	66.50	67.00	67.00	67.00
	Silent mode	dB(A)	63.00	63.50	63.50	64.00	64.00	64.00
Sound power	Normal mode	dB(A)	87.00	87.50	87.50	88.00	88.00	88.00
Dimension / Net weight	H x W x D	mm / kg	1842 x 4490 x 1000 / 1110	1842 x 4900 x 1000 / 1170	1842 x 4490 x 1000 / 1155	1842 x 4900 x 1000 / 1215	1842 x 4900 x 1000 / 1260	1842 x 4900 x 1000 / 1260
	Liquid pipe	Inch (mm)	3/4(19.05)/7/8(22.22)	3/4(19.05)/7/8(22.22)	3/4(19.05)/7/8(22.22)	3/4(19.05)/7/8(22.22)	3/4(19.05)/7/8(22.22)	3/4(19.05)/7/8(22.22)
Piping diameter ²⁾	Gas pipe	Inch (mm)	1-1/2(38.10)/1-5/8(41.28)	1-1/2(38.10)/1-5/8(41.28)	1-1/2(38.10)/1-5/8(41.28)	1-1/2(38.10)/1-5/8(41.28)	1-5/8(41.28)/1-3/4(44.45)	1-5/8(41.28)/1-3/4(44.45)
	Balance pipe	Inch (mm)	1/4(6.35)	1/4(6.35)	1/4(6.35)	1/4(6.35)	1/4(6.35)	1/4(6.35)
Refrigerant (R410A) / CO ₂ Eq.		kg / T	30.50/63.6840	33.20/69.3216	30.50/63.6840	33.20/69.3216	33.20/69.3216	33.20/69.3216
Maximum allowable indoor / outdoor capacity ratio % ³⁾			50 ~ 130(200)	50 ~ 130(200)	50 ~ 130(200)	50 ~ 130(200)	50 ~ 130(200)	50 ~ 130(200)
Operating range	Cool Min ~ Max	°C	-10 ~ +52	-10 ~ +52	-10 ~ +52	-10 ~ +52	-10 ~ +52	-10 ~ +52
	Heat Min ~ Max	°C	-25 ~ +18	-25 ~ +18	-25 ~ +18	-25 ~ +18	-25 ~ +18	-25 ~ +18
RRP		£	42.332	43.972	44.488	46.128	47.384	48.284

Data is for reference. 1) EER and COP calculation is based in accordance to EN14511. 2) Piping diameter under 90 m for ultimate indoor unit / over 90 m for ultimate indoor unit (if the longest piping equivalent length exceeds 90 m, increase the sizes of the main tubes by 1 rank for gas tubes and liquid tubes). 3) If the following conditions are satisfied, the effective range is above 130 % and below 200 %: A. Obey the limited number of connectable indoor units. B. The lower limit of operating range for heating outdoor temperature is limited to -10 °C WB (standard -25 °C WB). C. Simultaneous operation is limited to less than 130 % of connectable indoor units.

2-Pipe ECOi EX ME2 Series Space Saving Model Combination from 22 to 80 HP

Model name		22 HP	24 HP	26 HP	28 HP	30 HP	32 HP	34 HP	
		U-10ME2E8	U-12ME2E8	U-10ME2E8	U-12ME2E8	U-14ME2E8	U-16ME2E8	U-14ME2E8	
		U-12ME2E8	U-12ME2E8	U-16ME2E8	U-16ME2E8	U-16ME2E8	U-16ME2E8	U-20ME2E8	
Power supply	Voltage	V	380-400-415	380-400-415	380-400-415	380-400-415	380-400-415	380-400-415	
	Phase		Three phase	Three phase	Three phase	Three phase	Three phase	Three phase	
	Frequency	Hz	50	50	50	50	50	50	
Cooling capacity	kW	61.5	68.0	73.0	78.5	85.0	90.0	96.0	
EER ¹⁾	W/W	4.13	3.93	3.80	3.69	3.68	3.52	3.56	
SEER ²⁾		6.90	6.86	6.62	6.60	6.88	6.55	7.21	
Current	A	24.30-23.10-22.30	28.00-26.60-25.60	31.70-30.10-29.00	34.80-33.10-31.90	38.60-36.60-35.30	42.30-40.20-38.70	44.10-41.90-40.40	
Input power	kW	14.90	17.30	19.20	21.30	23.10	25.60	27.00	
Heating capacity	kW	69.0	76.5	81.5	87.5	95.0	100.0	108.0	
COP ¹⁾	W/W	4.76	4.69	4.55	4.56	4.48	4.42	4.17	
SCOP ²⁾		4.53	4.78	4.16	4.29	4.13	4.09	4.14	
Current	A	23.90-22.70-21.90	26.60-25.30-24.40	29.90-28.40-27.40	31.70-30.10-29.00	35.40-33.60-32.40	37.70-35.80-34.60	42.80-40.60-39.20	
Input power	kW	14.50	16.30	17.90	19.20	21.20	22.60	25.90	
Starting current	A	2.00	2.00	3.00	3.00	4.00	4.00	4.00	
External static pressure (Max)	Pa	80	80	80	80	80	80	80	
Maximum fuse size	A	25/30	30/30	25/40	30/40	35/40	40/40	35/60	
Air flow	m ³ /sec	7.60	7.73	7.60	7.73	7.73	7.73	10.62	
Sound pressure	Normal / Silent mode	dB(A)	61.00/58.00	62.00/59.00	62.50/59.50	63.50/60.50	63.50/60.50	64.00/61.00	63.00/60.00
Sound power	Normal mode	dB(A)	82.00	83.00	83.50	84.50	84.50	85.00	84.00
Dimension / Net weight	HxWxD	mm / kg	1842x2010 x1000/480	1842x2420 x1000/540	1842x2010 x1000/525	1842x2420 x1000/585	1842x2420 x1000/630	1842x2420 x1000/630	1842x2780 x1000/690
Piping diameter ³⁾	Liquid pipe	Inch (mm)	5/8(15.88)/ 3/4(19.05)	5/8(15.88)/ 3/4(19.05)	3/4(19.05)/ 7/8(22.22)	3/4(19.05)/ 7/8(22.22)	3/4(19.05)/ 7/8(22.22)	3/4(19.05)/ 7/8(22.22)	3/4(19.05)/ 7/8(22.22)
	Gas pipe	Inch (mm)	1-1/8(28.58)/ 1-1/4(31.75)	1-1/8(28.58)/ 1-1/4(31.75)	1-1/4(31.75)/ 1-1/2(38.10)	1-1/4(31.75)/ 1-1/2(38.10)	1-1/4(31.75)/ 1-1/2(38.10)	1-1/4(31.75)/ 1-1/2(38.10)	1-1/4(31.75)/ 1-1/2(38.10)
	Balance pipe	Inch (mm)	1/4(6.35)	1/4(6.35)	1/4(6.35)	1/4(6.35)	1/4(6.35)	1/4(6.35)	1/4(6.35)
Refrigerant (R410A) / CO ₂ Eq.	kg / T	13.90/23.3856	16.60/34.6608	13.90/29.0232	16.60/34.6608	16.60/34.6608	16.60/34.6608	17.80/37.1664	
Maximum allowable indoor / outdoor capacity ratio % ⁴⁾		50~130(200)	50~130(200)	50~130(200)	50~130(200)	50~130(200)	50~130(200)	50~130(200)	
Operating range	Cool Min ~ Max	°C	-10~+52	-10~+52	-10~+52	-10~+52	-10~+52	-10~+52	
	Heat Min ~ Max	°C	-25~+18	-25~+18	-25~+18	-25~+18	-25~+18	-25~+18	
RRP	£	18.190	19.830	20.346	21.986	23.242	24.142	25.738	

Model name		36 HP	38 HP	40 HP	42 HP	44 HP	46 HP	48 HP	
		U-16ME2E8	U-18ME2E8	U-20ME2E8	U-10ME2E8	U-12ME2E8	U-14ME2E8	U-16ME2E8	
		U-20ME2E8	U-20ME2E8	U-20ME2E8	U-16ME2E8	U-16ME2E8	U-16ME2E8	U-16ME2E8	
Power supply	Voltage	V	380-400-415	380-400-415	380-400-415	380-400-415	380-400-415	380-400-415	
	Phase		Three phase	Three phase	Three phase	Three phase	Three phase	Three phase	
	Frequency	Hz	50	50	50	50	50	50	
Cooling capacity	kW	101.0	107.0	113.0	118.0	124.0	130.0	135.0	
EER ¹⁾	W/W	3.42	3.42	3.34	3.69	3.62	3.62	3.52	
SEER ²⁾		6.86	7.32	7.16	6.57	6.6	6.7	6.55	
Current	A	47.70-45.30-43.70	50.60-48.10-46.30	54.10-51.40-49.50	52.80-50.20-48.40	56.00-53.20-51.30	59.90-56.90-54.90	63.40-60.20-58.10	
Input power	kW	25.9	31.3	33.8	32.0	34.3	35.9	38.4	
Heating capacity	kW	113.0	119.0	127.0	132.0	138.0	145.0	150.0	
COP ¹⁾	W/W	4.14	4.13	3.92	4.49	4.50	4.46	4.42	
SCOP ²⁾		4.06	4.14	4.13	4.11	4.21	4.12	4.09	
Current	A	44.60-42.40-40.80	47.10-44.70-43.10	52.40-49.80-48.00	49.10-46.60-44.90	50.70-48.20-46.40	54.30-51.50-49.7	56.60-53.80-51.8	
Input power	kW	27.30	28.80	32.40	29.40	30.70	32.50	33.90	
Starting current	A	4.00	4.00	4.00	5.00	5.00	6.00	6.00	
External static pressure (Max)	Pa	80	80	80	80	80	80	80	
Maximum fuse size	A	40/60	50/60	60/60	25/40/40	30/40/40	35/40/40	40/40/40	
Air flow	m ³ /sec	10.62	13.50	13.50	11.47	11.60	11.60	11.60	
Sound pressure	Normal / Silent mode	dB(A)	63.50/60.50	62.50/59.50	63.00/60.00	65.00/62.00	65.50/62.50	65.50/62.50	66.00/63.00
Sound power	Normal mode	dB(A)	84.50	83.50	84.00	86.00	86.50	86.50	87.00
Dimension / Net weight	HxWxD	mm / kg	1842x2780 x1000/690	1842x3140 x1000/750	1842x3140 x1000/750	1842x3250 x1000/840	1842x3660 x1000/900	1842x3660 x1000/945	1842x3660 x1000/945
Piping diameter ³⁾	Liquid pipe	Inch (mm)	3/4(19.05)/ 7/8(22.22)	3/4(19.05)/ 7/8(22.22)	3/4(19.05)/ 7/8(22.22)	3/4(19.05)/ 7/8(22.22)	3/4(19.05)/ 7/8(22.22)	3/4(19.05)/ 7/8(22.22)	
	Gas pipe	Inch (mm)	1-1/2(38.10)/ 1-5/8(41.28)	1-1/2(38.10)/ 1-5/8(41.28)	1-1/2(38.10)/ 1-5/8(41.28)	1-1/2(38.10)/ 1-5/8(41.28)	1-1/2(38.10)/ 1-5/8(41.28)	1-1/2(38.10)/ 1-5/8(41.28)	
	Balance pipe	Inch (mm)	1/4(6.35)	1/4(6.35)	1/4(6.35)	1/4(6.35)	1/4(6.35)	1/4(6.35)	
Refrigerant (R410A) / CO ₂ Eq.	kg / T	17.80/37.1664	19.00/39.672	19.00/39.672	22.20/46.3536	24.90/51.9912	24.90/51.9912	24.90/51.9912	
Maximum allowable indoor / outdoor capacity ratio % ⁴⁾		50~130(200)	50~130(200)	50~130(200)	50~130(200)	50~130(200)	50~130(200)	50~130(200)	
Operating range	Cool Min ~ Max	°C	-10~+52	-10~+52	-10~+52	-10~+52	-10~+52	-10~+52	
	Heat Min ~ Max	°C	-25~+18	-25~+18	-25~+18	-25~+18	-25~+18	-25~+18	
RRP	£	26.638	28.432	29.134	32.417	34.057	35.313	36.213	

1) EER and COP calculation is based in accordance to EN14511. 2) SEER / SCOP is calculated based on the seasonal space cooling / heating efficiency "η" values of the COMMISSION REGULATION (EU) 2016/2281. SEER, SCOP = (η + Correction) × PEF. 3) Piping diameter under 90 m for ultimate indoor unit / over 90 m for ultimate outdoor unit (if the longest piping equivalent length exceeds 90 m, increase the sizes of the main tubes by 1 rank for gas tubes and liquid tubes). 4) If the following conditions are satisfied, the effective range is above 130 % and below 200 %: A. Obey the limited number of connectable indoor units. B. The lower limit of operating range for heating outdoor temperature is limited to -10 °C WB (standard -25 °C WB). C. Simultaneous operation is limited to less than 130 % of connectable indoor units.

Model name			50 HP	52 HP	54 HP	56 HP	58 HP	60 HP	62 HP	64 HP
			U-14ME2E8	U-16ME2E8	U-14ME2E8	U-16ME2E8	U-18ME2E8	U-20ME2E8	U-14ME2E8	U-16ME2E8
			U-16ME2E8	U-16ME2E8	U-20ME2E8	U-20ME2E8	U-20ME2E8	U-20ME2E8	U-16ME2E8	U-16ME2E8
			U-20ME2E8	U-20ME2E8	U-20ME2E8	U-20ME2E8	U-20ME2E8	U-20ME2E8	U-16ME2E8	U-16ME2E8
Power supply	Voltage	V	380-400-415	380-400-415	380-400-415	380-400-415	380-400-415	380-400-415	380-400-415	380-400-415
	Phase		Three phase	Three phase	Three phase	Three phase	Three phase	Three phase	Three phase	Three phase
	Frequency	Hz	50	50	50	50	50	50	50	50
Cooling capacity		kW	140.0	145.0	151.0	156.0	162.0	168.0	174.0	180.0
EER ¹⁾		W/W	3.55	3.46	3.49	3.41	3.40	3.35	3.60	3.52
SEER ²⁾			6.96	6.72	7.16	6.92	7.3	7.16	6.68	6.55
Current		A	64.40-61.10-58.90	68.50-65.00-62.70	70.00-66.50-64.10	74.00-70.30-67.80	76.90-73.10-70.40	80.10-76.10-73.40	79.80-75.80-73.00	84.60-80.30-77.40
Input power		kW	39.40	41.90	43.30	45.80	47.60	50.10	48.30	51.20
Heating capacity		kW	155.0	160.0	169.0	175.0	182.0	189.0	195.0	201.0
COP ¹⁾		W/W	4.29	4.27	4.11	4.08	4.06	3.94	4.45	4.42
SCOP ³⁾			4.08	4.05	4.13	4.07	4.13	4.13	4.11	4.09
Current		A	59.60-56.60-54.60	61.90-58.80-56.70	67.10-63.80-61.50	70.10-66.60-64.20	73.20-69.50-67.00	77.60-73.70-71.00	73.10-69.50-67.00	76.00-72.20-69.6
Input power		kW	36.10	37.50	41.10	42.90	44.80	48.00	43.80	45.50
Starting current		A	6.00	6.00	6.00	6.00	6.00	6.00	8.00	8.00
External static pressure (Max)		Pa	80	80	80	80	80	80	80	80
Maximum fuse size		A	35/40/60	40/40/60	35/60/60	40/60/60	50/60/60	60/60/60	35/40/40/40	40/40/40/40
Air flow		m ³ /sec	14.48	14.48	17.37	17.37	20.25	20.25	15.47	15.47
Sound pressure	Normal / Silent mode	dB(A)	65.50/62.50	65.50/62.50	65.00/62.00	65.50/62.50	64.50/61.50	65.00/62.00	67.00/64.00	67.00/64.00
Sound power	Normal mode	dB(A)	86.50	86.50	86.00	86.50	85.50	86.00	88.00	88.00
Dimension / Net weight	HxWxD	mm / kg	1842x4020x1000/1005	1842x4020x1000/1005	1842x4380x1000/1065	1842x4380x1000/1065	1842x4740x1000/1125	1842x4740x1000/1125	1842x4900x1000/1260	1842x4900x1000/1260
Piping diameter ³⁾	Liquid pipe	Inch (mm)	3/4(19.05)/7/8(22.22)	3/4(19.05)/7/8(22.22)	3/4(19.05)/7/8(22.22)	3/4(19.05)/7/8(22.22)	3/4(19.05)/7/8(22.22)	3/4(19.05)/7/8(22.22)	3/4(19.05)/7/8(22.22)	3/4(19.05)/7/8(22.22)
	Gas pipe	Inch (mm)	1-1/2(38.10)/1-5/8(41.28)	1-1/2(38.10)/1-5/8(41.28)	1-1/2(38.10)/1-5/8(41.28)	1-1/2(38.10)/1-5/8(41.28)	1-1/2(38.10)/1-5/8(41.28)	1-1/2(38.10)/1-5/8(41.28)	1-5/8(41.28)/1-3/4(44.45)	1-5/8(41.28)/1-3/4(44.45)
	Balance pipe	Inch (mm)	1/4(6.35)	1/4(6.35)	1/4(6.35)	1/4(6.35)	1/4(6.35)	1/4(6.35)	1/4(6.35)	1/4(6.35)
Refrigerant (R410A) / CO ₂ Eq.		kg / T	26.10/54.4968	26.10/54.4968	27.30/57.0024	27.30/57.0024	28.50/59.508	28.50/59.508	33.20/69.3216	33.20/69.3216
Maximum allowable indoor / outdoor capacity ratio % ⁴⁾			50 ~ 130(200)	50 ~ 130(200)	50 ~ 130(200)	50 ~ 130(200)	50 ~ 130(200)	50 ~ 130(200)	50 ~ 130(200)	50 ~ 130(200)
Operating range	Cool Min ~ Max	°C	-10 ~ +52	-10 ~ +52	-10 ~ +52	-10 ~ +52	-10 ~ +52	-10 ~ +52	-10 ~ +52	-10 ~ +52
	Heat Min ~ Max	°C	-25 ~ +18	-25 ~ +18	-25 ~ +18	-25 ~ +18	-25 ~ +18	-25 ~ +18	-25 ~ +18	-25 ~ +18
RRP		£	37.809	38.709	40.305	41.205	42.999	43.701	47.384	48.284

Model name			66 HP	68 HP	70 HP	72 HP	74 HP	76 HP	78 HP	80 HP
			U-10ME2E8	U-12ME2E8	U-10ME2E8	U-16ME2E8	U-16ME2E8	U-16ME2E8	U-18ME2E8	U-20ME2E8
			U-16ME2E8	U-16ME2E8	U-20ME2E8	U-16ME2E8	U-18ME2E8	U-20ME2E8	U-20ME2E8	U-20ME2E8
			U-20ME2E8	U-20ME2E8	U-20ME2E8	U-20ME2E8	U-20ME2E8	U-20ME2E8	U-20ME2E8	U-20ME2E8
Power supply	Voltage	V	380-400-415	380-400-415	380-400-415	380-400-415	380-400-415	380-400-415	380-400-415	380-400-415
	Phase		Three phase	Three phase	Three phase	Three phase	Three phase	Three phase	Three phase	Three phase
	Frequency	Hz	50	50	50	50	50	50	50	50
Cooling capacity		kW	185.0	190.0	196.0	202.0	208.0	213.0	219.0	224.0
EER ¹⁾		W/W	3.52	3.49	3.47	3.42	3.42	3.39	3.38	3.35
SEER ²⁾			6.92	6.91	7.09	6.86	7.03	7.01	7.18	7.16
Current		A	85.00-80.80-77.80	88.10-83.70-80.70	91.30-86.80-83.60	95.40-90.60-87.30	98.30-93.40-90.00	101.70-96.60-93.10	103.50-98.30-94.70	106.80-101.50-97.80
Input power		kW	52.60	54.50	56.50	59.00	60.80	62.90	64.70	66.80
Heating capacity		kW	207.0	213.0	219.0	226.0	233.0	239.0	245.0	252.0
COP ¹⁾		W/W	4.16	4.18	4.05	4.14	4.12	4.03	4.03	3.94
SCOP ³⁾			4.11	4.17	4.13	4.06	4.12	4.07	4.13	4.13
Current		A	81.20-77.10-74.30	83.30-79.20-76.30	87.40-83.10-80.10	89.20-84.70-81.70	92.30-87.70-84.50	96.90-92.00-88.70	98.30-93.40-90.00	103.40-98.30-94.70
Input power		kW	49.70	51.00	54.10	54.60	56.50	59.30	60.80	64.00
Starting current		A	7.00	7.00	7.00	8.00	8.00	8.00	8.00	8.00
External static pressure (Max)		Pa	80	80	80	80	80	80	80	80
Maximum fuse size		A	25/40/60/60	30/40/60/60	25/60/60/60	40/40/60/60	40/50/60/60	40/60/60/60	50/60/60/60	60/60/60/60
Air flow		m ³ /sec	21.10	21.23	23.98	21.23	24.12	24.12	27.00	27.00
Sound pressure	Normal / Silent mode	dB(A)	66.00/63.00	66.50/63.50	65.50/62.50	66.50/63.50	66.50/63.50	66.50/63.50	66.00/63.00	66.00/63.00
Sound power	Normal mode	dB(A)	87.00	87.50	86.50	87.50	87.50	87.50	87.00	87.00
Dimension / Net weight	HxWxD	mm / kg	1842x5210x1000/1275	1842x5620x1000/1335	1842x5570x1000/1335	1842x5620x1000/1380	1842x5980x1000/1440	1842x5980x1000/1440	1842x6340x1000/1500	1842x6340x1000/1500
Piping diameter ³⁾	Liquid pipe	Inch (mm)	3/4(19.05)/7/8(22.22)	7/8(22.22)/1(25.04)	7/8(22.22)/1(25.04)	7/8(22.22)/1(25.04)	7/8(22.22)/1(25.04)	7/8(22.22)/1(25.04)	7/8(22.22)/1(25.04)	7/8(22.22)/1(25.04)
	Gas pipe	Inch (mm)	1-5/8(41.28)/1-3/4(44.45)	1-5/8(41.28)/1-3/4(44.45)	1-5/8(41.28)/1-3/4(44.45)	1-3/4(44.45)/2(50.80)	1-3/4(44.45)/2(50.80)	1-3/4(44.45)/2(50.80)	1-3/4(44.45)/2(50.80)	1-3/4(44.45)/2(50.80)
	Balance pipe	Inch (mm)	1/4(6.35)	1/4(6.35)	1/4(6.35)	1/4(6.35)	1/4(6.35)	1/4(6.35)	1/4(6.35)	1/4(6.35)
Refrigerant (R410A) / CO ₂ Eq.		kg / T	32.90/68.6952	35.60/74.3328	34.10/19.836	35.80/68.6952	36.80/76.8384	36.80/76.8384	38.00/79.344	38.00/79.344
Maximum allowable indoor / outdoor capacity ratio % ⁴⁾			50 ~ 130(200)	50 ~ 130(200)	50 ~ 130(200)	50 ~ 130(200)	50 ~ 130(200)	50 ~ 130(200)	50 ~ 130(200)	50 ~ 130(200)
Operating range	Cool Min ~ Max	°C	-10 ~ +52	-10 ~ +52	-10 ~ +52	-10 ~ +52	-10 ~ +52	-10 ~ +52	-10 ~ +52	-10 ~ +52
	Heat Min ~ Max	°C	-25 ~ +18	-25 ~ +18	-25 ~ +18	-25 ~ +18	-25 ~ +18	-25 ~ +18	-25 ~ +18	-25 ~ +18
RRP		£	49.480	51.120	51.976	53.276	55.070	55.772	57.566	58.268

1) EER and COP calculation is based in accordance to EN15111. 2) SEER / SCOP is calculated based on the seasonal space cooling / heating efficiency "η" values of the COMMISSION REGULATION (EU) 2016/2281. SEER, SCOP = (η + Correction) × PEF. 3) Piping diameter under 90 m for ultimate indoor unit / over 90 m for ultimate indoor unit (if the longest piping equivalent length exceeds 90 m, increase the sizes of the main tubes by 1 rank for gas tubes and liquid tubes). 4) If the following conditions are satisfied, the effective range is above 130 % and below 200 %: A. Obey the limited number of connectable indoor units. B. The lower limit of operating range for heating outdoor temperature is limited to -10 °C WB (standard -25 °C WB). C. Simultaneous operation is limited to less than 130 % of connectable indoor units.

Rating Conditions: Cooling Indoor 27 °C DB / 19 °C WB. Cooling Outdoor 35 °C DB / 24 °C WB. Heating Indoor 20 °C DB. Heating Outdoor 7 °C DB / 6 °C WB. (DB: Dry Bulb; WB: Wet Bulb). Specifications subject to change without notice. For detailed information about ErP / Energy Labelling, please visit our websites www.panasonic.co.uk/aircon or www.ptc.panasonic.eu.

3-Pipe ECOi EX MF3 Series



Simultaneous heating and cooling VRF system.
The Panasonic 3-Pipe MF3 Series offers the best solution for the most discerning customers and demanding installations.



Simultaneous heating and cooling VRF System

The Panasonic 3-Pipe ECOi EX MF3 Series offers the ideal solution to meet customer's demand.

Upgraded energy efficiency utilized ECOi EX technology.

- SEER / SCOP improved in full capacities from 8 to 16 HP
- SEER / SCOP follows LOT21 (January 2018)
- Eurovent certified EER / COP

Design flexibility.

- High reliability even under extreme temperature conditions
- Connection of up to 52 indoor units
- Slim heat recovery box with just 200 mm height
- Farthest piping length between indoor and outdoor units: 200 m

Excellent seasonal energy saving.

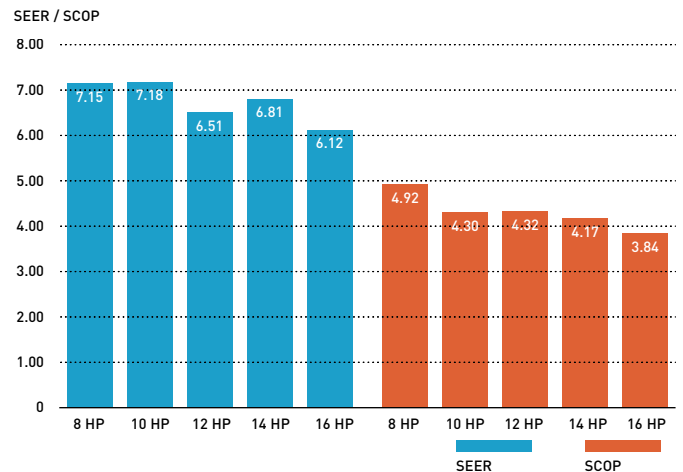

Extended design operation conditions

Cooling design operation conditions: The cooling operating range has been extended to -10 °C ~ 52 °C by changing the outdoor fan to an Inverter type.

Heating design operation conditions: Stable heating operation even with an outside air temperature of -20 °C. The heating operating range has been extended to -20 °C by use of a compressor with a high-pressure vessel.

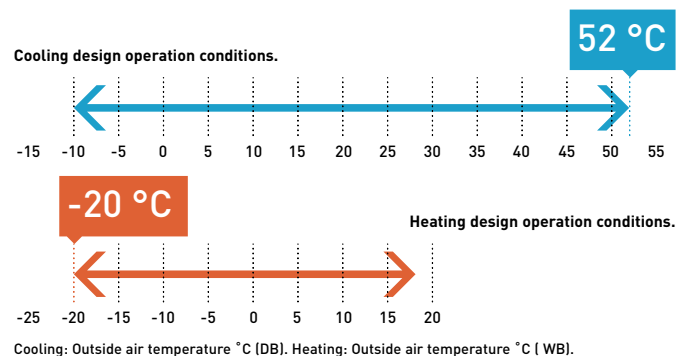

Wide temperature setting range

Wired remote controller heating temperature setting range is 16 to 30 °C as standard.



**4.92
SCOP**

3-Pipe ECOi EX MF3 Series

Simultaneous heating and cooling operation with heat recovery type.

The 3-Pipe ECOi EX MF3 Series is one of the most advanced VRF systems.

Not only high-efficient performance for simultaneous heating and cooling, but also sophisticated installation and maintenance capability.

		8 HP	10 HP	12 HP	14 HP	16 HP	
Outdoor units		U-8MF3E8	U-10MF3E8	U-12MF3E8	U-14MF3E8	U-16MF3E8	
Power supply	Voltage	V	380-400-415	380-400-415	380-400-415	380-400-415	
	Phase		Three phase	Three phase	Three phase	Three phase	
	Frequency	Hz	50	50	50	50	
Cooling capacity	kW	22.4	28.0	33.5	40.0	45.0	
EER ¹⁾	W/W	5.11	4.72	3.91	3.70	3.49	
SEER ²⁾		7.15	7.18	6.51	6.81	6.12	
$\eta_{s,c}$	%	277.7	278.9	252.7	264.4	237.7	
Current	A	7.16-6.80-6.55	9.90-9.41-9.07	3.19-13.20-12.70	18.20-17.30-16.70	21.30-20.20-19.50	
Input power	kW	4.38	5.93	8.57	10.80	12.90	
Heating capacity	kW	25.0	31.5	37.5	45.0	50.0	
COP ¹⁾	W/W	5.25	5.17	4.51	4.21	4.17	
SCOP ²⁾		4.92	4.30	4.32	4.17	3.84	
$\eta_{s,h}$	%	190.9	166.8	167.8	162.1	149.3	
Current	A	7.78-7.39-7.12	10.20-9.66-9.31	13.40-12.80-12.30	18.10-17.20-16.50	20.00-19.00-18.30	
Input power	kW	4.76	6.09	8.32	10.70	12.00	
Starting current	A	1.00	1.00	1.00	2.00	2.00	
External static pressure [Max]	Pa	80	80	80	80	80	
Maximum fuse size	A	25	25	30	40	40	
Air flow	m ³ /sec	3.50	3.67	3.87	3.87	3.87	
Sound pressure	Normal mode	dB(A)	54.00	57.00	60.00	61.00	62.00
	Silent mode 1 / 2	dB(A)	51.00/49.00	54.00/52.00	57.00/55.00	58.00/56.00	59.00/57.00
Sound power	Normal mode	dB(A)	76.00	78.00	81.00	82.00	82.00
Dimension	HxWxD	mm	1842x1180x1000	1842x1180x1000	1842x1180x1000	1842x1180x1000	1842x1180x1000
Net weight	kg	261	262	286	334	334	
Piping diameter ³⁾	Liquid pipe	Inch (mm)	3/8(9.52)/1/2(12.70)	3/8(9.52)/1/2(12.70)	1/2(12.70)/5/8(15.88)	1/2(12.70)/5/8(15.88)	1/2(12.70)/5/8(15.88)
	Discharge pipe	Inch (mm)	5/8(15.88)/3/4(19.05)	3/4(19.05)/7/8(22.22)	3/4(19.05)/7/8(22.22)	7/8(22.22)/1(25.40)	7/8(22.22)/1(25.40)
	Suction pipe	Inch (mm)	3/4(19.05)/7/8(22.22)	7/8(22.22)/1(25.40)	1(25.40)/1-1/8(28.58)	1(25.40)/1-1/8(28.58)	1-1/8(28.58)/1-1/4(31.75)
	Balance pipe	Inch (mm)	1/4(6.35)	1/4(6.35)	1/4(6.35)	1/4(6.35)	1/4(6.35)
Refrigerant (R410A) / CO ₂ Eq.	kg / T	6.80/14.1984	6.80/14.1984	8.30/17.3304	8.30/17.3304	8.30/17.3304	
Maximum allowable indoor / outdoor capacity ratio %		50 ~ 150	50 ~ 150	50 ~ 150	50 ~ 150	50 ~ 150	
Operating range	Cool Min ~ Max	°C	-10 ~ +52	-10 ~ +52	-10 ~ +52	-10 ~ +52	-10 ~ +52
	Heat Min ~ Max	°C	-20 ~ +18	-20 ~ +18	-20 ~ +18	-20 ~ +18	-20 ~ +18
	Simultaneous op.	°C	-10 ~ +24	-10 ~ +24	-10 ~ +24	-10 ~ +24	-10 ~ +24
RRP	£	7.812	8.621	9.964	11.524	13.243	

1) EER and COP calculation is based in accordance to EN14511. 2) SEER / SCOP is calculated based on the seasonal space cooling / heating efficiency "η" values of the COMMISSION REGULATION (EU) 2016/2281. SEER, SCOP = (η + Correction) × PEF. 3) Piping diameter under 90 m for ultimate indoor unit / over 90 m for ultimate indoor unit (if the longest piping equivalent length exceeds 90 m, increase the sizes of the main tubes by 1 rank for gas tubes and liquid tubes). 4) Available for S-45/56/73/106MK2E5B.

Solenoid valve kit		RRP £	
KIT-P56HR3	KIT-P56HR3	3-Pipe control Solenoid valve kit (up to 5.6 kW)	497
	CZ-P56HR3	Solenoid valve kit (up to 5.6 kW)	409
KIT-P160HR3	CZ-CAPE2	3-Pipe control PCB	91
	KIT-P160HR3	3-Pipe control Solenoid valve kit (from 5.6 to 16.0 kW)	586
	CZ-P160HR3	Solenoid valve kit (from 5.6 kW to 16.0 kW)	497
CZ-CAPE2 ⁴⁾	CZ-CAPE2	3-Pipe control PCB	91
		3-Pipe control PCB for wall-mounted	99

3-Pipe control box kit		RRP £
CZ-P456HR3	4 ports 3 pipe box (up to 5.6 kW per port)	2.495
CZ-P656HR3	6 ports 3 pipe box (up to 5.6 kW per port)	3.424
CZ-P856HR3	8 ports 3 pipe box (up to 5.6 kW per port)	4.667
CZ-P4160HR3	4 ports 3 pipe box (up to 16.0 kW per port)	2.781

- Achieving SCOP 4.92 as the top class in the industry (LOT21 Seasonal heating efficiency value for 8 HP outdoor unit)
- Simultaneous cooling and heating operation with up to 39 indoor units
- Slim heat recovery boxes with just 200 mm height fit with the ceiling space limited in hotel applications

Technical focus

- High SEER / SCOP at full Load capacity (follows LOT21)
- Eurovent certified EER / COP
- Standardisation of outdoor unit to one compact casing size
- Connection of up to 52 indoor units
- High external static pressure 80 Pa with a newly designed fan, fan guard, motor, and casing
- Silent outdoor unit operation: Minimum 54 dB(A) for 8 HP
- Bluefin coil coating as standard



Slim 3-Pipe control box kit / Multiple connection type

Heat recovery Box to connect multiple indoor units with just one box, 4, 6 and up to 8 indoor units or groups.

The height is only 200 mm, which is especially advantageous in hotel applications, where space for connecting several boxes is limited.

Individual control of multiple indoor units with solenoid valve kits.

- Any design and layout can be used in a single system.
- Cooling operation is possible up to an outdoor temperature of -10 °C.

System structure.

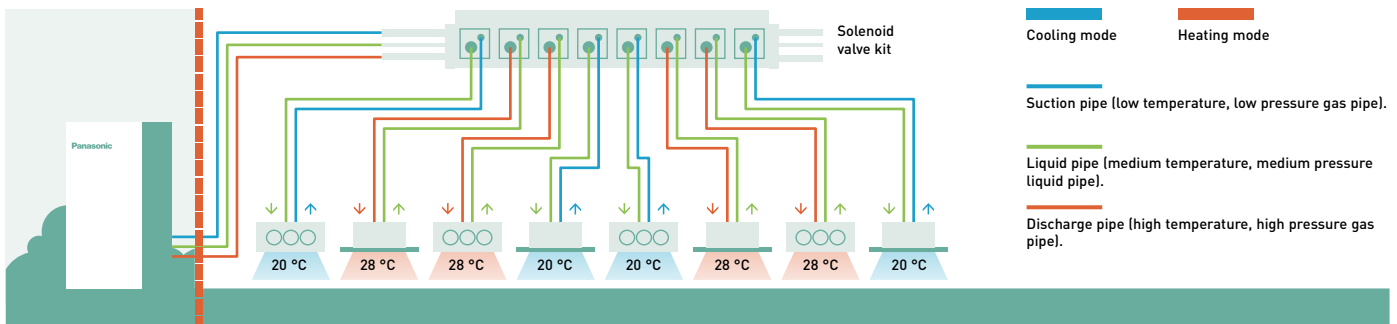

	1 port	4 port	6 port	8 port
56 type	CZ-P56HR3	CZ-P456HR3	CZ-P656HR3	CZ-P856HR3
160 type	CZ-P160HR3	CZ-P4160HR3	—	—

Solenoid valve kit / wiring work

Current model / single connection type.

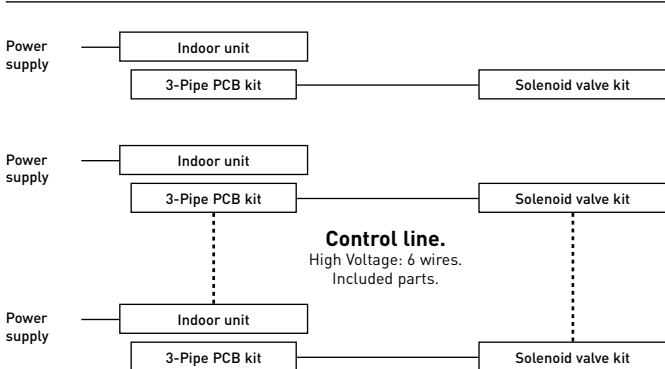

New model / multiple connection type.

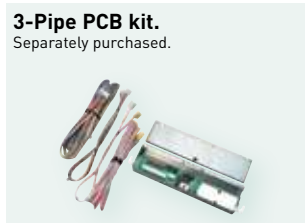
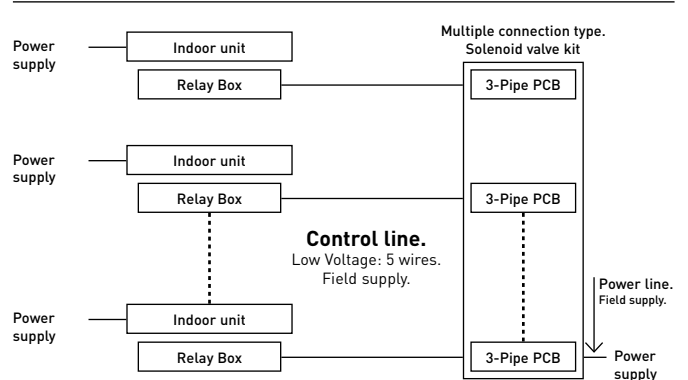

3-Pipe ECOi EX MF3 Series Combination from 18 to 48 HP

HP		18 HP	20 HP	22 HP	24 HP	26 HP	28 HP	30 HP	32 HP
Model name		U-8MF3E8	U-8MF3E8	U-10MF3E8	U-12MF3E8	U-10MF3E8	U-12MF3E8	U-14MF3E8	U-16MF3E8
		U-10MF3E8	U-12MF3E8	U-12MF3E8	U-12MF3E8	U-16MF3E8	U-16MF3E8	U-16MF3E8	U-16MF3E8
Power supply	Voltage	V	380-400-415	380-400-415	380-400-415	380-400-415	380-400-415	380-400-415	380-400-415
	Phase		Three phase	Three phase	Three phase	Three phase	Three phase	Three phase	Three phase
	Frequency	Hz	50	50	50	50	50	50	50
Cooling capacity	kW	50.0	56.0	61.5	68.0	73.0	78.5	85.0	90.0
EER ¹⁾	W/W	4.90	4.31	4.24	3.89	3.88	3.65	3.59	3.49
Current	A	16.8/16.0/15.4	21.0/20.0/19.2	23.7/22.5/21.7	28.3/26.9/25.9	31.0/29.5/28.4	35.1/33.4/32.2	39.6/37.6/36.2	42.6/40.5/39.0
Input power	kW	10.20	13.00	14.50	17.50	18.80	21.50	23.70	25.8
Heating capacity	kW	56.0	63.0	69.0	76.5	81.5	87.5	95.0	100.0
COP ¹⁾	W/W	5.23	4.77	4.79	4.47	4.50	4.31	4.19	4.17
Current	A	17.7/16.8/16.2	21.3/20.3/19.5	23.5/22.3/21.5	27.6/26.3/25.3	30.2/28.7/27.7	33.5/31.8/30.7	37.9/36.0/34.7	40.1/38.1/36.7
Input power	kW	10.70	13.20	14.40	17.10	18.10	20.30	22.70	24.00
Starting current	A	2.00	2.00	2.00	2.00	3.00	3.00	4.00	4.00
External static pressure (Max)	Pa	80	80	80	80	80	80	80	80
Maximum fuse size	A	25/25	25/30	25/30	30/30	25/40	30/40	40/40	40/40
Air flow	m ³ /sec	7.17	7.37	7.53	7.73	7.53	7.73	7.73	7.73
Sound pressure	Normal mode	dB(A)	59.00	61.00	62.00	63.00	63.50	64.50	65.00
	Silent mode 1 / 2	dB(A)	56.00/54.00	58.00/56.00	59.00/57.00	60.00/58.00	60.50/58.50	61.50/59.50	61.50/59.50
Sound power	Normal mode	dB(A)	81.50	84.00	84.50	86.00	84.50	86.00	86.00
Dimension	HxWxD	mm	1842x2360 (+60)x1000	1842x2360 (+60)x1000	1842x2360 (+60)x1000	1842x2360 (+60)x1000	1842x2360 (+60)x1000	1842x2360 (+60)x1000	1842x2360 (+60)x1000
Net weight	kg	523	547	548	574	596	620	668	668
Piping diameter ²⁾	Liquid pipe	Inch (mm)	5/8(15.88)/ 3/4(19.05)	5/8(15.88)/ 3/4(19.05)	5/8(15.88)/ 3/4(19.05)	5/8(15.88)/ 3/4(19.05)	3/4(19.05)/ 7/8(22.22)	3/4(19.05)/ 7/8(22.22)	3/4(19.05)/ 7/8(22.22)
	Discharge pipe	Inch (mm)	7/8(22.22)/ 1(25.40)	7/8(22.22)/ 1(25.40)	1(25.40)/ 1-1/8(28.58)	1(25.40)/ 1-1/8(28.58)	1(25.40)/ 1-1/8(28.58)	1-1/8(28.58)/ 1-1/4(31.75)	1-1/8(28.58)/ 1-1/4(31.75)
	Suction pipe	Inch (mm)	1-1/8(28.58)/ 1-1/4(31.75)	1-1/8(28.58)/ 1-1/4(31.75)	1-1/8(28.58)/ 1-1/4(31.75)	1-1/8(28.58)/ 1-1/4(31.75)	1-1/8(28.58)/ 1-1/2(38.10)	1-1/4(31.75)/ 1-1/2(38.10)	1-1/4(31.75)/ 1-1/2(38.10)
	Balance pipe	Inch (mm)	1/4(6.35)	1/4(6.35)	1/4(6.35)	1/4(6.35)	1/4(6.35)	1/4(6.35)	1/4(6.35)
Refrigerant [R410A] / CO ₂ Eq.	kg / T	13.60/28.3968	15.10/31.5288	15.10/31.5288	16.60/34.6608	15.10/31.5288	16.60/34.6608	16.60/34.6608	16.60/34.6608
Maximum allowable indoor / outdoor capacity ratio %		50 ~ 150	50 ~ 150	50 ~ 150	50 ~ 150	50 ~ 150	50 ~ 150	50 ~ 150	50 ~ 150
Operating range	Cool Min - Max	°C	-10 ~ +52	-10 ~ +52	-10 ~ +52	-10 ~ +52	-10 ~ +52	-10 ~ +52	-10 ~ +52
	Heat Min - Max	°C	-20 ~ +18	-20 ~ +18	-20 ~ +18	-20 ~ +18	-20 ~ +18	-20 ~ +18	-20 ~ +18
	Simultaneous op.	°C	-10 ~ +24	-10 ~ +24	-10 ~ +24	-10 ~ +24	-10 ~ +24	-10 ~ +24	-10 ~ +24
RRP	£	16.433	17.776	18.585	19.928	21.864	23.207	24.767	26.486

HP		34 HP	36 HP	38 HP	40 HP	42 HP	44 HP	46 HP	48 HP
Model name		U-8MF3E8	U-8MF3E8	U-10MF3E8	U-8MF3E8	U-10MF3E8	U-12MF3E8	U-14MF3E8	U-16MF3E8
		U-10MF3E8	U-12MF3E8	U-12MF3E8	U-16MF3E8	U-16MF3E8	U-16MF3E8	U-16MF3E8	U-16MF3E8
Power supply	Voltage	V	380-400-415	380-400-415	380-400-415	380-400-415	380-400-415	380-400-415	380-400-415
	Phase		Three phase	Three phase	Three phase	Three phase	Three phase	Three phase	Three phase
	Frequency	Hz	50	50	50	50	50	50	50
Cooling capacity	kW	96.0	101.0	107.0	113.0	118.0	124.0	130.0	135.0
EER ¹⁾	W/W	4.10	3.90	3.88	3.72	3.72	3.58	3.55	3.49
Current	A	38.6/36.7/35.4	42.3/40.2/38.7	45.6/43.3/41.7	50.2/47.7/46.0	52.4/49.7/47.9	56.5/53.7/51.8	61.1/58.1/56.0	63.9/60.7/58.5
Input power	kW	23.40	25.90	27.60	30.40	31.70	34.60	36.60	38.70
Heating capacity	kW	108.0	113.0	119.0	127.0	132.0	138.0	145.0	150.0
COP ¹⁾	W/W	4.64	4.48	4.51	4.31	4.36	4.25	4.18	4.17
Current	A	38.9/37.0/35.6	41.6/39.5/38.1	43.6/41.4/39.9	49.3/46.8/45.1	50.6/48.1/46.3	53.7/51.0/49.1	57.9/55.0/53.0	60.1/57.1/55.0
Input power	kW	23.30	25.20	26.40	29.50	30.30	32.50	34.70	36.00
Starting current	A	4.00	4.00	4.00	5.00	5.00	5.00	6.00	6.00
External static pressure (Max)	Pa	80	80	80	80	80	80	80	80
Maximum fuse size	A	25/25/40	25/30/40	25/30/40	25/40/40	25/40/40	30/40/40	40/40/40	40/40/40
Air flow	m ³ /sec	11.03	11.23	11.40	11.23	11.40	11.60	11.60	11.60
Sound pressure	Normal mode	dB(A)	64.00	64.50	65.00	65.50	66.00	66.50	66.50
	Silent mode 1 / 2	dB(A)	61.00/59.00	61.50/59.50	62.00/60.00	62.50/60.50	63.00/61.00	63.50/61.50	63.50/61.50
Sound power	Normal mode	dB(A)	84.50	85.50	85.50	85.50	86.00	86.50	87.00
Dimension	HxWxD	mm	1842x3540 (+120)x1000	1842x3540 (+120)x1000	1842x3540 (+120)x1000	1842x3540 (+120)x1000	1842x3540 (+120)x1000	1842x3540 (+120)x1000	1842x3540 (+120)x1000
Net weight	kg	857	881	882	929	930	954	1002	1002
Piping diameter ²⁾	Liquid pipe	Inch (mm)	3/4(19.05)/ 7/8(22.22)	3/4(19.05)/ 7/8(22.22)	3/4(19.05)/ 7/8(22.22)	3/4(19.05)/ 7/8(22.22)	3/4(19.05)/ 7/8(22.22)	3/4(19.05)/ 7/8(22.22)	3/4(19.05)/ 7/8(22.22)
	Discharge pipe	Inch (mm)	1-1/8(28.58)/ 1-1/4(31.75)	1-1/8(28.58)/ 1-1/4(31.75)	1-1/4(31.75)/ 1-1/2(38.10)	1-1/4(31.75)/ 1-1/2(38.10)	1-1/4(31.75)/ 1-1/2(38.10)	1-1/4(31.75)/ 1-1/2(38.10)	1-1/4(31.75)/ 1-1/2(38.10)
	Suction pipe	Inch (mm)	1-1/4(31.75)/ 1-1/2(38.10)	1-1/2(38.10)/ 1-5/8(41.28)	1-1/2(38.10)/ 1-5/8(41.28)	1-1/2(38.10)/ 1-5/8(41.28)	1-1/2(38.10)/ 1-5/8(41.28)	1-1/2(38.10)/ 1-5/8(41.28)	1-1/2(38.10)/ 1-5/8(41.28)
	Balance pipe	Inch (mm)	1/4(6.35)	1/4(6.35)	1/4(6.35)	1/4(6.35)	1/4(6.35)	1/4(6.35)	1/4(6.35)
Refrigerant [R410A] / CO ₂ Eq.	kg / T	21.90/45.72719	23.40/48.85919	23.40/48.85919	23.40/48.85919	23.40/48.85919	24.90/46.3536	24.90/51.9912	24.90/51.9912
Maximum allowable indoor / outdoor capacity ratio %		50 ~ 150	50 ~ 150	50 ~ 150	50 ~ 150	50 ~ 150	50 ~ 150	50 ~ 150	50 ~ 150
Operating range	Cool Min - Max	°C	-10 ~ +52	-10 ~ +52	-10 ~ +52	-10 ~ +52	-10 ~ +52	-10 ~ +52	-10 ~ +52
	Heat Min - Max	°C	-20 ~ +18	-20 ~ +18	-20 ~ +18	-20 ~ +18	-20 ~ +18	-20 ~ +18	-20 ~ +18
	Simultaneous op.	°C	-10 ~ +24	-10 ~ +24	-10 ~ +24	-10 ~ +24	-10 ~ +24	-10 ~ +24	-10 ~ +24
RRP	£	29.676	31.019	31.828	34.298	35.107	36.450	38.010	39.729

1) EER and COP calculation is based in accordance to EN14511. 2) Piping diameter under 90 m for ultimate indoor unit / over 90 m for ultimate indoor unit (if the longest piping equivalent length exceeds 90 m, increase the sizes of the main tubes by 1 rank for gas tubes and liquid tubes).

Rating Conditions: Cooling Indoor 27 °C DB / 19 °C WB, Cooling Outdoor 35 °C DB / 24 °C WB, Heating Indoor 20 °C DB, Heating Outdoor 7 °C DB / 6 °C WB. [DB: Dry Bulb; WB: Wet Bulb]. Specifications subject to change without notice. For detailed information about ErP / Energy Labelling, please visit our websites www.panasonic.co.uk/aircon or www.ptc.panasonic.eu.



Eurovent certified technical data: 2-Pipe ECOi EX ME2 Series 8 to 20 HP · R410A

HP	8 HP		10 HP		12 HP		14 HP		16 HP		18 HP		20 HP		
Outdoor units	U-8ME2E8		U-10ME2E8		U-12ME2E8		U-14ME2E8		U-16ME2E8		U-18ME2E8		U-20ME2E8		
Indoor units combination	MF2	MU2	MF2	MU2	MF2	MU2	MF2	MU2	MF2	MU2	MF2	MU2	MF2	MU2	
Cooling	Pc out ¹⁾ kW	19.7	19.7	24.6	24.6	33.5	33.5	40	40	45	45	50	50	56	56
	Pec out ²⁾ kW	5.79	5.79	8.79	8.79	11.55	11.55	13.33	13.33	18.75	18.75	17.86	17.86	23.33	23.33
	EERout	3.4	3.4	2.8	2.8	2.9	2.9	3	3	2.4	2.4	2.8	2.8	2.4	2.4
Seasonal Cooling	SEER	7.4	7.4	7	7	6.7	6.7	7.2	7.2	6.4	6.4	7.6	7.6	7	7
	$\eta_{s,c}$ %	294.3	294.3	275.4	275.4	266.6	266.6	286	286	254.3	254.3	299.2	299.2	278.2	277
Cooling PL	PcB kW	14.5	14.5	18.1	18.1	24.6	24.6	29.4	29.4	33.1	33.1	36.8	36.8	41.2	41.2
Condition B	EERB	5.7	5.7	4.8	4.8	4.6	4.6	4.9	4.9	4.2	4.2	5	5	4.6	4.6
Cooling PL	PcC kW	9.3	9.3	11.6	11.6	15.8	15.8	18.9	18.9	21.3	21.3	23.6	23.6	26.5	26.5
Condition C	EERC	11.8	11.8	9.6	9.6	8.1	8.1	9.4	9.4	8.2	8.2	9.8	9.8	9	9
Cooling PL	PcD kW	8.2	8.2	9.3	9.3	8.2	8.2	8.4	8.4	9.4	9.4	10.5	10.5	11.7	11.7
Condition D	EERD	13.7	13.7	18.9	18.9	18.4	18.4	22.6	22.6	22.1	22.1	25.2	25.2	24.6	24.6
Seasonal Heating	Pdesignh kW	17.5	17.5	22	22	26.2	26.2	31.5	31.5	35	35	39.2	39.2	44.1	44.1
	SCOP	4.8	4.8	4.3	4.3	4.7	4.7	4.3	4.3	4.1	4.1	4.3	4.3	4.1	4.1
	$\eta_{s,h}$ %	188.4	188.4	167.6	167.6	185.8	185.8	168.2	168.2	159	159	168.7	168.7	160.4	161
Heating PL	PhA kW	15.4	15.4	19.4	19.4	23.1	23.1	27.8	27.8	30.9	30.9	34.6	34.6	39	39
Condition A	COPA	2.8	2.8	2.6	2.6	2.8	2.8	2.5	2.5	2.3	2.3	2.6	2.6	2.4	2.4
Heating PL	PhB kW	9.4	9.4	11.8	11.8	14.1	14.1	16.9	16.9	18.8	18.8	21.1	21.1	23.7	23.7
Condition B	COPB	4.5	4.5	3.6	3.6	4.2	4.2	3.7	3.7	3.6	3.6	3.7	3.7	3.5	3.5
Heating PL	PhC kW	6	6	7.6	7.6	9	9	10.9	10.9	12.1	12.1	13.5	13.5	15.2	15.2
Condition C	COPC	7.2	7.2	7.7	7.7	7.7	7.7	7.4	7.4	6.6	6.6	7.1	7.1	6.9	6.9
Heating PL	PhD kW	7.1	7.1	7	7	7.2	7.2	6.7	6.7	6.6	6.6	7.4	7.4	7.4	7.4
Condition D	COPD	8.9	8.9	9.6	9.6	9.3	9.3	10.2	10.2	10	10	10.3	10.3	10.3	10.3
T bivalent	Tbiv °C	-9	-9	-7	-7	-9	-9	-7	-7	-7	-7	-7	-7	-7	-7
	PhTbiv kW	16.8	16.8	19.4	19.4	25.1	25.1	27.8	27.8	30.9	30.9	34.6	34.6	39	39
	COPTbiv	2.6	2.6	2.6	2.6	2.6	2.6	2.5	2.5	2.3	2.3	2.6	2.6	2.4	2.4
Psbc	W	48	48	48	48	48	48	88	88	88	88	88	88	88	88
Psbh	W	48	48	48	48	48	48	88	88	88	88	88	88	88	88
Poffc	W	48	48	48	48	48	48	88	88	88	88	88	88	88	88
Poffh	W	48	48	48	48	48	48	88	88	88	88	88	88	88	88
Ptoc	W	48	48	48	48	48	48	88	88	88	88	88	88	88	88
Ptoh	W	48	48	48	48	48	48	88	88	88	88	88	88	88	88
Pckc	W	48	48	48	48	48	48	88	88	88	88	88	88	88	88
Pckh	W	48	48	48	48	48	48	88	88	88	88	88	88	88	88
PSB	W	48	48	48	48	48	48	88	88	88	88	88	88	88	88
Sound power level	dB(A)	80	80	81	81	85	85	86	86	87	87	86	86	86	86
Sound power level in heating	dB(A)	81	81	84	84	85	85	85	85	89	89	89	89	89	89

Eurovent certified technical data: 3-Pipe ECOi EX MF3 Series 8 to 16 HP · R410A

HP	8 HP		10 HP		12 HP		14 HP		16 HP		
Outdoor units	U-8MF3E8		U-10MF3E8		U-12MF3E8		U-14MF3E8		U-16MF3E8		
Indoor units combination	MF2	MU2	MF2	MU2	MF2	MU2	MF2	MU2	MF2	MU2	
Cooling	Pc out ¹⁾ kW	22.4	22.4	28	28	33.5	33.5	40	40	45	45
	Pec out ²⁾ kW	7.23	7.23	10.77	10.77	12.88	12.88	15.38	15.38	19.57	19.57
	EERout	3.1	3.1	2.6	2.6	2.6	2.6	2.6	2.6	2.3	2.3
Seasonal Cooling	SEER	7	7	7	7	6.4	6.4	6.7	6.7	6	6
	$\eta_{s,c}$ %	277	277.7	278.9	278.9	252.7	252.7	264.4	264.4	237.7	237.7
Cooling PL	PcB kW	16.5	16.5	20.6	20.6	24.6	24.6	29.4	29.4	33.1	33.1
Condition B	EERB	4.9	4.9	4.6	4.6	4.3	4.3	4.4	4.4	3.9	3.9
Cooling PL	PcC kW	10.6	10.6	13.2	13.2	15.8	15.8	18.9	18.9	21.3	21.3
Condition C	EERC	9.1	9.1	9.3	9.3	7.7	7.7	8.3	8.3	7.4	7.4
Cooling PL	PcD kW	7.2	7.2	8.5	8.5	7.1	7.1	8.5	8.5	9.4	9.4
Condition D	EERD	16.5	16.5	19.7	19.7	15.7	15.7	19.7	19.7	17.4	17.4
Seasonal Heating	Pdesignh kW	17.5	17.5	22	22	26.2	26.2	31.5	31.5	35	35
	SCOP	4.8	4.8	4.2	4.2	4.3	4.3	4.1	4.1	3.8	3.8
	$\eta_{s,h}$ %	189	190.9	166.8	166.8	167.8	167.8	162.1	162.1	149.3	149.3
Heating PL	PhA kW	15.4	15.4	19.4	19.4	23.1	23.1	27.8	27.8	30.9	30.9
Condition A	COPA	2.9	2.9	2.5	2.5	2.7	2.7	2.4	2.4	2.2	2.2
Heating PL	PhB kW	9.4	9.4	11.8	11.8	14.1	14.1	16.9	16.9	18.8	18.8
Condition B	COPB	4.6	4.6	3.7	3.7	3.7	3.7	3.6	3.6	3.3	3.3
Heating PL	PhC kW	6	6	7.6	7.6	9	9	10.9	10.9	12.1	12.1
Condition C	COPC	7.1	7.1	7.4	7.4	6.9	6.9	7.1	7.1	6.5	6.5
Heating PL	PhD kW	6.7	6.7	6.9	6.9	6.5	6.5	6.6	6.6	6.6	6.6
Condition D	COPD	8.7	8.7	9.4	9.4	9	9	9.6	9.6	9.6	9.6
T bivalent	Tbiv °C	-9	-9	-7	-7	-9	-9	-7	-7	-7	-7
	PhTbiv kW	16.8	16.8	19.4	19.4	25.1	25.1	27.8	27.8	30.9	30.9
	COPTbiv	2.6	2.6	2.5	2.5	2.3	2.3	2.4	2.4	2.2	2.2
Psbc	W	17	17	17	17	17	17	25	25	25	25
Psbh	W	50	50	50	50	50	50	91	91	91	91
Poffc	W	17	17	17	17	17	17	25	25	25	25
Poffh	W	50	50	50	50	50	50	91	91	91	91
Ptoc	W	17	17	17	17	17	17	25	25	25	25
Ptoh	W	50	50	50	50	50	50	91	91	91	91
Pckc	W	50	50	50	50	50	50	91	91	91	91
Pckh	W	50	50	50	50	50	50	91	91	91	91
PSB	W	50	50	50	50	50	50	91	91	91	91
Sound power level	dB(A)	79	79	80	80	84	84	86	86	86	86
Sound power level in heating	dB(A)	77	77	82	82	86	86	86	86	88	88

Panasonic introducing the gas driven VRF

ECO G gas VRF is specially designed for buildings where the electricity is restricted or CO₂ emissions must be reduced.



1 Limited electric supply

Electric consumption of ECO G is only 9 % compared to ECOi because gas engine is utilized for the compressor driving force.

2 High demand of DHW with heating and cooling cogeneration

DHW is produced effectively thanks to heat from engine exhaust during heating and cooling.

3 Open and flexible design

ECO G system is designed to connect various Indoor units and controllers which are available for ECOi systems. With GE3 series, pump down system has been implemented to answer commercial needs.

4 Quick start up in heating at low ambient temperature

Gas heat pump systems make your building comfortably warm with a quick start by using waste heat from engine. Heating mode works from an ambient temperature of -21 °C.

Comparison of heating capacity.

Room temperature °C

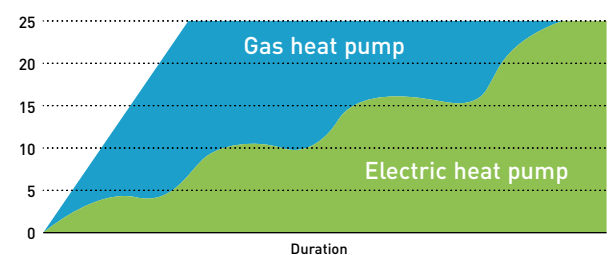

2-Pipe ECO G GE3 Series

Designed for better energy efficiency. SEER has been increased by up to 120 %.



3-Pipe ECO G GF3 Series

3 Way heat recovery system with simultaneous heating and cooling.

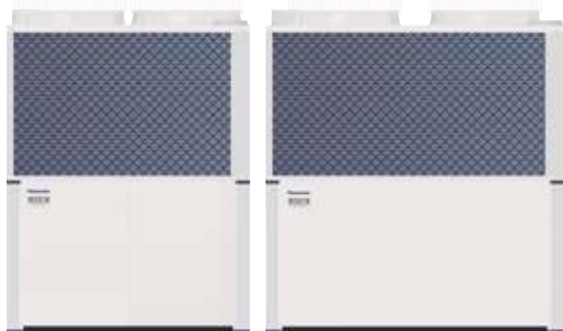

2-Pipe ECO G GE3 Series

The GE3 Series has a top level of seasonal efficiency in this category. In addition, this product fits with special needs for commercial application thanks to DHW priority setting and auto pump down functions.

HP			16 HP	20 HP	25 HP	30 HP
Model			U-16GE3E5	U-20GE3E5	U-25GE3E5	U-30GE3E5
Power supply	Voltage	V	220 - 230 - 240	220 - 230 - 240	220 - 230 - 240	220 - 230 - 240
	Phase		Single phase	Single phase	Single phase	Single phase
	Frequency	Hz	50	50	50	50
Cooling capacity		kW	45.0	56.0	71.0	85.0
Refrigeration load Pdesign		kW	45.0	56.0	71.0	85.0
$\eta_{s,c}$ (LOT21)		%	220.60	219.30	240.10	229.30
Input power		kW	1.17	1.12	1.80	1.80
Hot water in cooling mode (at 65 °C outlet)		kW	23.60	29.10	36.40	46.00
Max COP in hot water		W/W	1.55	1.55	1.49	1.47
Gas consumption cooling		kW	41.10	52.10	67.20	84.10
Heating capacity	Standard	kW	50.0	63.0	80.0	95.0
	Low temperature	kW	53.0	67.0	78.0	90.0
Refrigeration load Pdesign		kW	37.0	53.0	60.0	65.0
$\eta_{s,h}$ (LOT21)		%	150.60	143.70	146.90	151.30
Input power		kW	0.56	1.05	0.91	1.75
Gas consumption heating	Standard	kW	38.00	51.10	68.60	75.30
	Low temperature	kW	45.40	62.70	60.70	73.90
Starter amperes		A	30	30	30	30
External static pressure		Pa	10	10	10	10
Air flow		m ³ /sec	6.17	7.00	7.67	7.67
Sound power	Normal	dB(A)	80	80	84	84
	Silent mode	dB(A)	77	77	81	81
Dimension	H x W x D	mm	2255 x 1650 x 1000	2255 x 1650 x 1000	2255 x 2026 x 1000	2255 x 2026 x 1000
Net weight		kg	765	765	870	880
Piping diameter	Liquid pipe	Inch (mm)	1/2 (12.70)	5/8 (15.88)	5/8 (15.88)	3/4 (19.05)
	Gas pipe	Inch (mm)	1-1/8 (28.58)	1-1/8 (28.58)	1-1/8 (28.58)	1-1/4 (31.75)
	Fuel gas	Inch (mm)	19.05 (R3/4)	19.05 (R3/4)	19.05 (R3/4)	19.05 (R3/4)
	Exhaust drain port	mm	25	25	25	25
	Hot water supply in/out		Rp3/4 (Nut. thread)	Rp3/4 (Nut. thread)	Rp3/4 (Nut. thread)	Rp3/4 (Nut. thread)
Elevation difference (in / out)			50	50	50	50
Refrigerant (R410A) / CO ₂ Eq.		kg / T	11.50/24.00	11.50/24.00	11.50/24.00	11.50/24.00
Maximum number of connectable indoor units			26	33	41	50
Operating range	Cool Min ~ Max	°C (DB)	-10 ~ +43	-10 ~ +43	-10 ~ +43	-10 ~ +43
	Heat Min ~ Max	°C (WB)	-21 ~ +18	-21 ~ +18	-21 ~ +18	-21 ~ +18
RRP		€	32.377	36.901	39.425	44.059

Hot water take out function added, EU safety regulation standard cleared. 25 HP chassis enlarged due to specification improvement. Pre-coat corrosion fin. Auto pump down function.

Technical focus

- Superior seasonal energy efficiency, maximum 240.1 %
- DHW priority setting
- Operating range in heating down to -21 °C and up to +24 °C for air to water system
- No defrost cycle

- Capacity ratio 50 ~ 200 % ¹⁾
- Option of DX or chilled water for indoor heat exchange
- Maximum total piping length: 780 m

¹⁾ 50 ~ 200 % only when one outdoor unit is installed. In other cases 50 ~ 130 %.

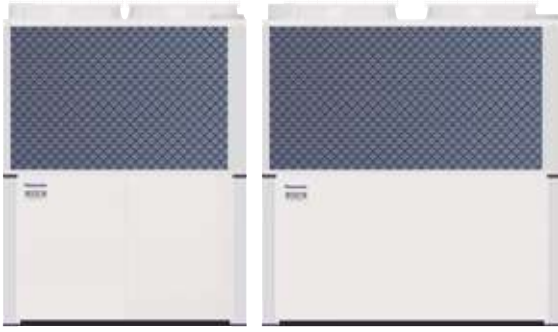

2-Pipe ECO G GE3 Series combination from 32 to 60 HP

The GE3 Series has a top level of seasonal efficiency in this category. In addition, this product fits with special needs for commercial application thanks to DHW priority setting and Auto pump down functions.

HP			32 HP	36 HP	40 HP	45 HP	50 HP	55 HP	60 HP
Model			U-16GE3E5	U-16GE3E5	U-20GE3E5	U-20GE3E5	U-25GE3E5	U-25GE3E5	U-30GE3E5
			U-16GE3E5	U-20GE3E5	U-20GE3E5	U-25GE3E5	U-25GE3E5	U-30GE3E5	U-30GE3E5
Power supply	Voltage	V	220 - 230 - 240	220 - 230 - 240	220 - 230 - 240	220 - 230 - 240	220 - 230 - 240	220 - 230 - 240	220 - 230 - 240
	Phase		Single phase	Single phase	Single phase	Single phase	Single phase	Single phase	Single phase
	Frequency	Hz	50	50	50	50	50	50	50
Cooling capacity	kW		90.0	101.0	112.0	127.0	142.0	156.0	170.0
Input power	kW		2.34	2.29	2.24	2.92	3.60	3.60	3.60
Hot water in cooling mode (at 65 °C outlet)	kW		47.20	52.70	58.20	65.50	72.80	82.40	92.00
Max COP in hot water	W/W		1.55	1.55	1.55	1.52	1.49	1.48	1.47
Gas consumption cooling	kW		82.20	93.20	104.20	119.30	134.40	151.30	168.20
Heating capacity	Standard	kW	100.0	113.0	126.0	143.0	160.0	175.0	190.0
	Low temperature	kW	106.0	120.0	134.0	145.0	156.0	168.0	180.0
Input power	kW		1.12	1.61	2.10	1.96	1.82	2.66	3.50
Gas consumption heating	Standard	kW	76.00	89.10	102.20	119.70	137.20	143.90	150.60
	Low temperature	kW	90.80	108.10	125.40	123.40	121.40	134.60	147.80
Starter amperes	A		30	30	30	30	30	30	30
External static pressure	Pa		10	10	10	10	10	10	10
Air flow	m ³ /sec		6.17/6.17	6.17/7.00	7.00/7.00	7.00/7.67	7.67/7.67	7.67/7.67	7.67/7.67
Sound power	Normal	dB(A)	83	83	83	86	87	87	87
	Silent mode	dB(A)	80	80	80	83	84	84	84
Dimension	Height	mm	2255	2255	2255	2255	2255	2255	2255
	Width	mm	1650+100 +1650	1650+100 +1650	1650+100 +1650	1650+100 +2026	2026+100 +2026	2026+100 +2026	2026+100 +2026
	Depth	mm	1000	1000	1000	1000	1000	1000	1000
Net weight		kg	1530(765+765)	1530(765+765)	1530(765+765)	1635(765+870)	1740(870+870)	1750(870+880)	1760(880+880)
	Liquid pipe	Inch (mm)	3/4(19.05)	3/4(19.05)	3/4(19.05)	3/4(19.05)	3/4(19.05)	7/8(22.22)	7/8(22.22)
Piping diameter	Gas pipe	Inch (mm)	1-1/4(31.75)	1-1/4(31.75)	1-1/2(38.10)	1-1/2(38.10)	1-1/2(38.10)	1-1/2(38.10)	1-1/2(38.10)
	Fuel gas	Inch (mm)	19.05(R3/4)	19.05(R3/4)	19.05(R3/4)	19.05(R3/4)	19.05(R3/4)	19.05(R3/4)	19.05(R3/4)
	Exhaust drain port	mm	25	25	25	25	25	25	25
	Hot water supply in/out		Rp3/4 (Nut. thread)	Rp3/4 (Nut. thread)	Rp3/4 (Nut. thread)	Rp3/4 (Nut. thread)	Rp3/4 (Nut. thread)	Rp3/4 (Nut. thread)	Rp3/4 (Nut. thread)
Elevation difference (in / out)		50	50	50	50	50	50	50	
Refrigerant (R410A) / CO ₂ Eq.	kg / T		2x11.50/24.00	2x11.50/24.00	2x11.50/24.00	2x11.50/24.00	2x11.50/24.00	2x11.50/24.00	2x11.50/24.00
Maximum number of connectable indoor units			52	59	64	64	64	64	64
Operating range	Cool Min - Max	°C	-10 ~ +43	-10 ~ +43	-10 ~ +43	-10 ~ +43	-10 ~ +43	-10 ~ +43	-10 ~ +43
	Heat Min - Max	°C	-21 ~ +18	-21 ~ +18	-21 ~ +18	-21 ~ +18	-21 ~ +18	-21 ~ +18	-21 ~ +18
RRP	€		64.754	69.278	73.802	76.326	78.850	83.484	88.118

Data is for reference. Hot water take out function added, EU safety regulation standard cleared. 25 HP chassis enlarged due to specification improvement. Pre-coat corrosion fin. Auto pump down function.

Technical focus

- Maximum 60 HP combination
- Superior seasonal energy efficiency, maximum 240.1 %
- DHW priority setting
- Operating range in heating down to -21 °C and up to +24 °C for air to water system
- No defrost cycle
- Option of DX or chilled water for indoor heat exchange
- Maximum total piping length: 780 m

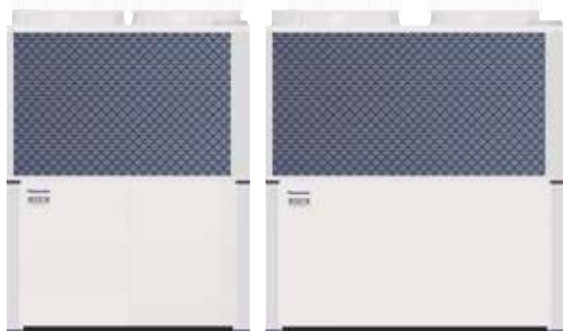

3-Pipe ECO G GF3 Series

DHW available in all seasons.

Effective production of domestic hot water from engine waste heat in both heating and cooling, all year round.

HP			16 HP	20 HP	25 HP
Model			U-16GF3E5	U-20GF3E5	U-25GF3E5
Power supply	Voltage	V	220 - 230 - 240	220 - 230 - 240	220 - 230 - 240
	Phase		Single phase	Single phase	Single phase
	Frequency	Hz	50	50	50
Cooling capacity		kW	45.0	56.0	71.0
Refrigeration load Pdesign		kW	45.0	56.0	71.0
$\eta_{s,c}$ (LOT21)		%	185.20	198.80	204.90
Input power		kW	1.17	1.40	1.80
Hot water in cooling mode (at 65 °C outlet)		kW	23.60	27.10	40.50
Gas consumption cooling		kW	45.80	54.80	73.70
Heating capacity	Standard	kW	50.0	63.0	80.0
	Low temperature	kW	53.0	67.0	78.0
Refrigeration load Pdesign		kW	38.0	52.0	60.0
$\eta_{s,h}$ (LOT21)		%	139.20	140.20	150.90
Input power		kW	0.56	1.05	0.91
Gas consumption heating	Standard	kW	42.20	51.10	68.60
Starter amperes		A	30	30	30
Air flow		m ³ /sec	6.17	6.67	7.67
Sound power	Normal	dB(A)	80	81	84
	Silent mode	dB(A)	77	78	81
Dimension	HxWxD	mm	2255 x 1650 x 1000	2255 x 1650 x 1000	2255 x 2026 x 1000
Net weight		kg	775	775	880
Piping diameter	Liquid pipe	Inch (mm)	3/4 (19.05)	3/4 (19.05)	3/4 (19.05)
	Gas pipe	Inch (mm)	1 1/8 (28.58)	1 1/8 (28.58)	1 1/8 (28.58)
	Discharge	Inch (mm)	7/8 (22.22)	1 (25.40)	1 (25.40)
	Fuel gas	Inch (mm)	19.05 (R3/4)	19.05 (R3/4)	19.05 (R3/4)
	Exhaust drain port	mm	25	25	25
	Hot water supply in/out		Rp3/4 (Nut. thread)	Rp3/4 (Nut. thread)	Rp3/4 (Nut. thread)
Elevation difference (in / out)		m	50	50	50
Refrigerant (R410A) / CO ₂ Eq.		kg / T	11.50 / 24.00	11.50 / 24.00	11.50 / 24.00
Maximum number of connectable indoor units			24	24	24
Operating range	Cool Min ~ Max	°C	-10 ~ +43	-10 ~ +43	-10 ~ +43
	Heat Min ~ Max	°C	-21 ~ +18	-21 ~ +18	-21 ~ +18
RRP		£	34,348	38,163	41,334

Hot water take out function added, EU safety regulation standard cleared. 25 HP chassis enlarged due to specification improvement. Pre-coat corrosion fin. Auto pump down function.

Solenoid valve kit			RRP £
KIT-P56HR3	KIT-P56HR3	3-Pipe control Solenoid valve kit (up to 5.6 kW)	497
	CZ-P56HR3	Solenoid valve kit (up to 5.6 kW)	409
	CZ-CAPE2	3-Pipe control PCB	91
KIT-P160HR3	KIT-P160HR3	3-Pipe control Solenoid valve kit (from 5.6 to 16.0 kW)	586
	CZ-P160HR3	Solenoid valve kit (from 5.6 kW to 16.0 kW)	497
	CZ-CAPE2	3-Pipe control PCB	91
CZ-CAPEK2 ¹⁾		3-Pipe control PCB for wall-mounted	99

3-Pipe control box kit			RRP £
CZ-P456HR3		4 ports 3 pipe box (up to 5.6 kW per port)	2,495
CZ-P656HR3		6 ports 3 pipe box (up to 5.6 kW per port)	3,424
CZ-P856HR3		8 ports 3 pipe box (up to 5.6 kW per port)	4,667
CZ-P4160HR3		4 ports 3 pipe box (up to 16.0 kW per port)	2,781

1) Available for S-45/56/73/106MK2E5B.

Outstanding seasonal energy efficiency, maximum 204.9 %

- Capacity ratio 50 ~ 200 %
- No defrost cycle
- Maximum total piping length: 780 m

Flexible installation

- Full heating capacity down to -21 °C (WB)
- DHW production for all the year
- Connection of up to 24 indoor units

Panasonic GHP/EHP Hybrid System. First intelligent technology

Taking advantage of Gas and Electricity to achieve better energy savings.

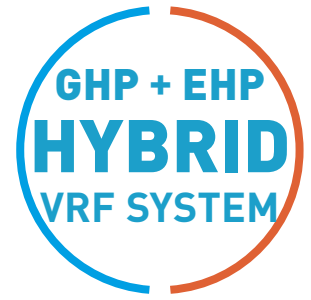

Panasonic's reliable ECO G / ECOi technology provides energy savings, utilising the advantage of both gas and electricity

The hybrid system can offer intelligent operation logic for better economy and efficiency by taking the best of ECO G a heating and cooling system operating in a similar was to a hybrid car.

GHP
GAS



U-20GES3E5 (20 HP)

+

EHP
ELECTRIC



U-10MES2E8 (10 HP)

+



Intelligent controller CZ-256ESMC3

- Master unit GHP**
- Load calculation of GHP and EHP
 - Operation in accordance with the upper limit setting
 - Individual capacity control
 - Device control
 - Special control (Defrost, Oil recovery, 4 Way-valve matching / Abnormality processing)

Slave Unit EHP

- Intelligent controller**
- Demand monitoring
 - Indoor / Total load calculation
 - Operation Ratio Indication upper limit setting of MAP according to:
 - Energy unit RRP
 - Electric power demand
 - Air conditioning load

Schematic of GHP / EHP Hybrid System.

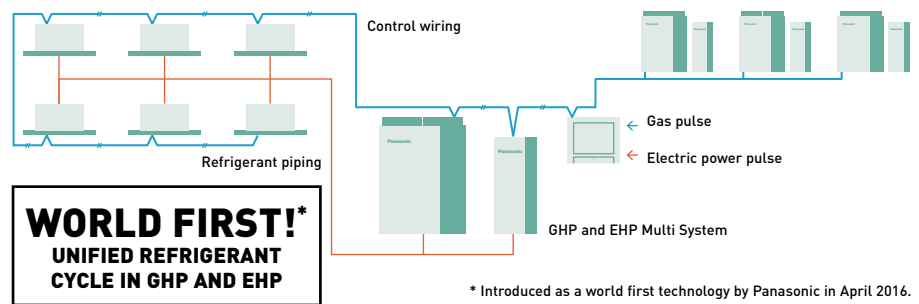

* Introduced as a world first technology by Panasonic in April 2016.



2-Pipe Hybrid GHP/EHP

- Extended lifespan with intelligent energy management. The goal is for the EHP and GHP to work at optimal speeds
- Low energy cost
- Low emissions

HP			Hybrid GHP	Hybrid EHP
Outdoor units			20 HP	10 HP
			U-20GES3E5	U-10MES2E8
Power supply	Voltage	V	220 - 230 - 240	380 - 400 - 415
	Phase		Single phase	Three phase
	Frequency	Hz	50	50
Cooling capacity		kW	56.0	28.0
$\eta_{s,h}$ (LOT21)		%	211.80	275.40
Current		A	5.18	10.70/10.20/9.80
Input power		kW	1.12	6.41
Hot water in cooling mode (at 65 °C outlet)		kW	26.20	—
Gas consumption cooling		kW	52.10	—
Heating capacity		kW	63.0	31.5
$\eta_{s,h}$ (LOT21)		%	143.20	167.60
Current		A	4.79	11.10/10.50/10.10
Input power		kW	1.05	6.62
Gas consumption heating	Standard	kW	51.10	—
Starting current		A	30	1
Air flow		m ³ /sec	7.00	3.73
Sound pressure	Normal mode	dB(A)	58	56
Sound power	Normal mode	dB(A)	80	77
Dimension	HxWxD	mm	2255x1650x1000	1842x770x1000
Net weight		kg	765	210
Piping diameter ¹⁾	Liquid pipe	Inch (mm)	5/8(15.88)	3/8(9.52)
	Gas pipe	Inch (mm)	1 1/8(28.58)	7/8(22.22)
	Balance pipe	Inch (mm)	1/4(6.35)	1/4(6.35)
Drain heater		W	40	—
Refrigerant (R410A) / CO ₂ Eq.		kg / T	11.05/23.0724	5.60/11.6928
Maximum allowable indoor / outdoor capacity ratio %			50 - 130	50 - 130
Operating range	Cool Min ~ Max	°C	-10 ~ +43	-10 ~ +43
	Heat Min ~ Max	°C	-21 ~ +18	-21 ~ +18
RRP		£	38.455	9.927

1) Please refer service manual when the maximum piping length exceeds 90 meters (equivalent length).

Technical focus

- 4 different setting (Economy, Efficiency, GHP first mode, EHP first mode)
- DHW energy recovery 26.2 kW (at 65 °C) by waste heat of engine
- Unified refrigerant cycle in GHP and EHP for easy installation
- DHW priority mode with WHE system
- Connection of up to 48 indoor units



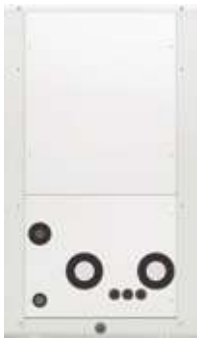

ECOi 2-Pipe with water heat exchanger for chilled and hot water production

Water heat exchanger (WHE) for hydronic applications. WHE for ECOi system controlled by a CZ-RTC5B timer remote control. Energy-efficient capacity control with superior external static pressure is now ready.

Hydrokit with A class water pump		PAW-250WP5G1	PAW-500WP5G1
Hydrokit without pump		PAW-250W5G1	PAW-500W5G1
Cooling capacity at 35 °C, water outlet 7 °C	kW	25.0	50.0
Heating capacity	kW	28.0	56.0
Heating capacity at +7 °C, heating water temperature at 45 °C	kW	28.0	56.0
COP at +7 °C, heating water temperature at 45 °C	W/W	2.97	3.10
Heating Energy Efficiency class at 35 °C ¹⁾		A++	A++
$\eta_{s,h}$ (LOT1) ²⁾	%	152.00	152.00
Dimension	HxWxD	mm	1000 x 575 x 1110
Net weight		kg	135 (140 with pump)
Water pipe connector			Rp2 Female Thread (50A)
Heating water flow ($\Delta T=5$ K, 35 °C)	m ³ /h	5.16	10.32
Capacity of integrated electric heater	kW	Not equipped	Not equipped
Flow switch		Equipped	Equipped
Water filter		Equipped	Equipped
Input power with A class water pump / without pump	kW	0.329 / 0.024	0.574 / 0.024
Maximum current with A class water pump / without pump	A	1.43 / 0.10	2.50 / 0.10
Outdoor unit		U-10ME2E8	U-20ME2E8
Sound pressure		dB(A)	56
Dimension	HxWxD	mm	1842 x 770 x 1000
Net weight		kg	210
Piping diameter	Liquid pipe	Inch (mm)	3/8 (9.52)
	Gas pipe	Inch (mm)	7/8 (22.22)
Refrigerant (R410A) / CO ₂ Eq.	kg	5.6 *Need Additional gas amount at site	9.5 *Need Additional gas amount at site
Pipe length range / Pipe length for nominal capacity	m	170 / 7.5	170 / 7.5
Elevation difference (in / out)	m	50 (OD above) 35 (OD below)	50 (OD above) 35 (OD below)
Pipe length for additional gas / Additional gas amount (R410A)	m / g/m	0 < / Refer to manual	0 < / Refer to manual
Operating range	Heat Min ~ Max	°C	-11 ~ +15 ³⁾
Water outlet temperature range	Cool Min ~ Max	°C	+5 ~ +15
	Heat Min ~ Max	°C	+35 ~ +45
Hydrokit with A class water pump RRP	£	12.195	12.898
Hydrokit without pump RRP	£	11.586	12.253
Outdoor unit RRP	£	8.275	14.567

1) Unit efficiency energy level: Scale from A+++ to D. 2) Seasonal space cooling / heating energy efficiency following COMMISSION REGULATION (EU) 813/2013. 3) With accessory low temperature kit -25 ~ +15 °C. Available only as a spare part.

Performance calculation in agreement with Eurovent. Sound pressure measured at 1 m from the outdoor unit and at 1.5 m height.

Accessories		RRP £
PAW-3WSK	Stacking kit for vertically stacking up to 3 WHE (4 pieces per Kit)	182

Stacking kit PAW-3WSK.

It is possible to stack up to 3 units. When stacking units, always anchor the bottom unit to the ground using the anchor holes.

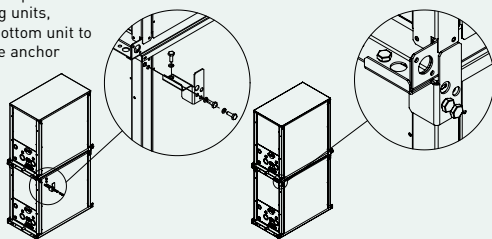

Availability of easy vertical stacking allows installations in a limited space (up to 3 units)*.

* Stacking kit (PAW-3WSK) is necessary.

Stainless steel plate heat exchanger with anti-freeze protection control. Change over between heating and cooling operation.

Technical focus

- Heating, cooling and DHW
- A class water pump included (only in P model)
- Flexible modularity from 25 kW
- Better partial load vs standard chiller system
- Compatible with all centralized controllers
- Maximum distance between outdoor unit and WHE: 170 m
- Maximum hot water outlet temperature: 45 °C
- Minimum chilled water outlet temperature: 5 °C
- Outdoor temperature range in heating mode: -11 °C to +15 °C (with low temperature kit -25 °C*)

* Available as a spare part.



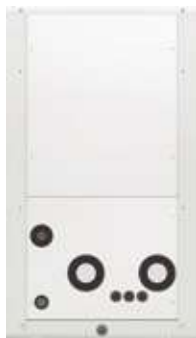

ECO G with water heat exchanger for chilled and hot water production

Water heat exchanger (WHE) for hydronic applications.

WHE for ECO G system controlled by a timer remote control CZ-RTC5B.

Energy-efficient capacity control with superior external static pressure is now ready.

Hydrokit with A class water pump			PAW-500WP5G1	PAW-710WP5G1
Hydrokit without pump			PAW-500W5G1	PAW-710W5G1
Cooling capacity	kW		—	—
Cooling capacity at +35 °C, outlet temperature 7 °C, inlet temperature 12 °C	kW		50.0	67.0
EER at +35 °C, outlet temperature 7 °C, inlet temperature 12 °C	W/W		0.78	0.89
Heating capacity	kW		60.0	80.0
Heating capacity at +7 °C, heating water temperature at 35 °C	kW		60.9	81.2
COP at +7 °C, heating water temperature at 35 °C	W/W		1.15	1.18
Heating capacity at +7 °C, heating water temperature at 45 °C	kW		60.0	80.0
COP at +7 °C, heating water temperature at 45 °C	W/W		1.02	1.04
Heating capacity at -7 °C, heating water temperature at 35 °C	kW		48.2	50.8
COP at -7 °C, heating water temperature at 35 °C	W/W		0.80	0.80
Heating capacity at -15 °C, heating water temperature at 35 °C	kW		46.3	50.0
COP at -15 °C, heating water temperature at 35 °C	W/W		0.80	0.80
Refrigeration load Pdesign	kW		48.0	—
Heating Energy Efficiency class at 35 °C¹⁾			A+	—
$\eta_{s,h}$ (LOT1) ²⁾	%		130.00	128.00
Dimension	H x W x D	mm	1000 x 575 x 1110	1000 x 575 x 1110
Net weight		kg	155 (165 with pump)	160 (175 with pump)
Water pipe connector			Rp2 Female Thread (50A)	Rp2 Female Thread (50A)
Heating water flow ($\Delta T=5$ K, 35 °C)	m ³ /h		10.32	13.76
Capacity of integrated electric heater	kW		Not equipped	Not equipped
Flow switch			Equipped	Equipped
Water filter			Equipped	Equipped
Input power with A class water pump / without pump	kW		0.574 / 0.024	0.824 / 0.024
Maximum current with A class water pump / without pump	A		2.50 / 0.10	3.60 / 0.10
Outdoor unit			U-20GE3E5	U-30GE3E5
Sound power	Normal / Silent	dB(A)	80 / 77	84 / 81
Dimension	H x W x D	mm	2255 x 1650 x 1000	2255 x 2026 x 1000
Net weight		kg	765	880
Piping diameter	Liquid pipe	Inch (mm)	5/8 (15.88)	3/4 (19.05)
	Gas pipe	Inch (mm)	1-1/8 (28.58)	1-1/4 (31.75)
Refrigerant (R410A) / CO ₂ Eq.		kg / T	11.50 / 24.00	11.50 / 24.00
Pipe length / Pipe length for nominal capacity		m	170 / 7	170 / 7
Elevation difference (in / out)		m	50 (OD above) 35 (OD below)	50 (OD above) 35 (OD below)
Operating range	Heat Min ~ Max	°C	-21 ~ +24 (until outlet temperature 45)	-21 ~ +24 (until outlet temperature 45)
Water outlet temperature range	Cool Min ~ Max	°C	-15 ~ +15	-15 ~ +15
	Heat Min ~ Max	°C	+35 ~ +55	+35 ~ +55
Hydrokit with A class pump RRP		£	12.898	14.834
Hydrokit without pump RRP		£	12.253	14.092
Outdoor unit RRP		£	36.901	44.059

1) Unit efficiency energy level: Scale from A+++ to D. 2) Seasonal space cooling / heating energy efficiency following COMMISSION REGULATION (EU) 813/2013. Performance calculation in agreement with Eurovent. Sound pressure measured at 1 m from the outdoor unit and at 1.5 m height.

Accessories		RRP £
PAW-3WSK	Stacking kit for vertically stacking up to 3 WHE (4 pieces per Kit)	182

Availability of easy vertical stacking allows installations in a limited space (up to 3 units)*.

Stainless steel plate heat exchanger with anti-freeze protection control.

Change over between heating and cooling operation.

* Stacking kit (PAW-3WSK) is necessary.

Technical focus

- Heating, cooling and DHW
- A class water pump included (only in P model)
- Installation up to 80 kW
- Free DHW from waste heat of engine
- Compatible with all centralized controllers
- Maximum distance between outdoor unit and WHE: 170 m
- Hot water outlet temperatures from 35 °C to 55 °C
- Chilled water outlet temperatures from -15 °C to +15 °C
- Minimum outdoor temperature in heating mode: -21 °C



Leak detection and automatic refrigerant pump down for R410A refrigerant

New line-up of pump down to detect refrigerant leaks, that offers complete assurance and safety protection. It's an ideal solution for hotels, offices and public buildings where the strict safety for end users and workers is required.



The system monitors refrigerant leakage continually and provides a warning, preventing major refrigerant loss and potentially damaging the system's efficiency. The system can reduce potential refrigerant loss by up to 90 %.

As well as ensuring safe and reliable operation, Panasonic's pump down system contributes to a building qualifying for additional BREEAM points and enables compliance with current EN 378 standards, covering applications where refrigeration concentration levels exceed practical safety limits of 0.44 kg/m³.

Basic pump down function:

- Leak detection
- Activating pump down process
- Collecting the gas in the receiver tank
- Closing the valves to isolate the gas

Technical focus:

- Compatible with Mini ECOi / ECOi EX / ECO G* Series with R410 refrigerant
- A receiver kit included as standard
- An updated controller included
- Connection in two ways:
 - 1 | With local room leakage sensors
 - 2 | Using innovative algorithm
- R22 renewal possible

* For connection to GHP, additional component required dependent on configuration. Please contact your local Panasonic representative for details.



The pump down systems are ideal for hotels, offices and public buildings where safety of building occupiers is a must and are extremely cost effective.

Direct leak detection method: the safest solution for small rooms

The leak detector is connected directly to the indoor unit and the pump down system is directly connected to the outdoor unit PCB.

The pump down system will activate when a leak is detected in the room and initiate a refrigerant reclaim operation immediately.

This immediate reaction, and large refrigerant storage capacity, offers very high level of safety for end users, building occupiers, as well as being environmentally friendly.

No additional communication panels, cabling or software is required.

This option should be implemented in any area in non-compliance with BS EN 378:2008.

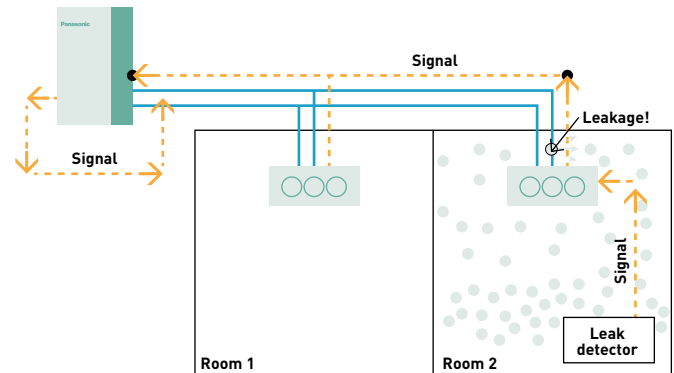

In-direct leak detection method: Unique PLC algorithm to determine refrigerant leakage

Pressure and temperature sensors constantly monitor the high / low pressure and discharge of the condensing unit to protect against potential leakage in areas not covered by leak detectors.

The innovative algorithm is able to detect leakage of R410A based on abnormal changes in the following conditions, high / low pressure and compressor discharge temperature.

Once initiated via either direct or in-direct detection, the unit will immediately close the liquid / discharge actuating ball valves, close the alarm terminals on the pump down PCB allowing an alarm to be raised at any nominated location. Reclaim of the refrigerant is via the suction line to the heat exchanger(s) of the outdoor unit(s), with any surplus refrigerant collected in the 30 l receiver tank. Once fully pumped down the suction line is closed and the unit awaits a 'Reset' and 'Recharge' command.

Thanks to the simple installation and control, shown in Fig 1, Panasonic's ECOi pump down system can provide dramatic reduction in capital cost and installation time when compared to a standalone leak detection system, shown in Fig 2.

Fig 1: Panasonic's pump down system.

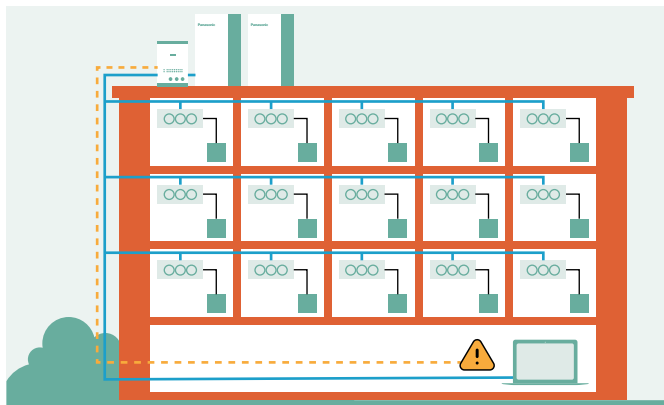
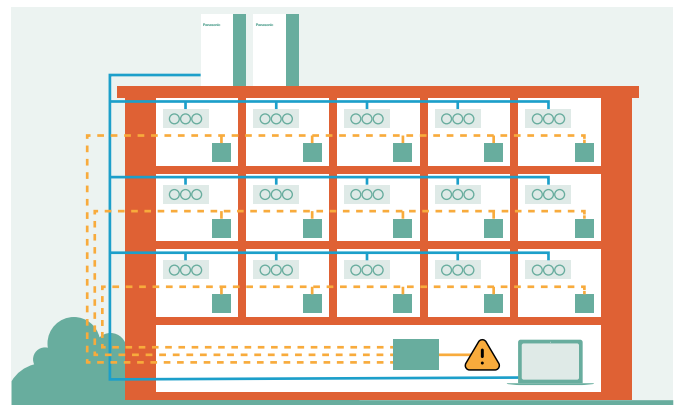

Fig 2: Standalone leak detection system.































































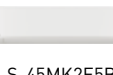

Quick and simple installation

The unit contains actuating ball valves, a 30 L storage vessel and PLC all housed in an IP54 rated container. Terminals in front of the unit allow easy wiring to the alarm terminal, high / low pressure transducers and discharge temperature sensor(s) of the condensing unit(s).



















































Reference	Description
PAW-PUD2W-1R	Pump down system (2 way) for 1 outdoor unit
PAW-PUD2W-2R	Pump down system (2 way) for 2 outdoor units
PAW-PUD2W-3R*	Pump down system (2 way) for 3 outdoor units
PAW-PUD3W-1R	Pump down system (3 way) for 1 outdoor unit
PAW-PUD3W-2R	Pump down system (3 way) for 2 outdoor units
PAW-PUD3W-3R*	Pump down system (3 way) for 3 outdoor units

* Special order requiring the longer lead time than usual. For the detailed information, please contact an authorized Panasonic dealer.

ECOi and ECO G systems indoor units range

Page		1.5 kW	2.2 kW	2.8 kW	3.0 kW	3.6 kW	4.0 kW	4.5 kW
P. 121	U2 Type 4 way 90x90 cassette · R32 / R410A		 S-22MU2E5B	 S-28MU2E5B		 S-36MU2E5B		 S-45MU2E5B
P. 122	NEW Y3 Type 4 way 60x60 cassette · R32 / R410A	 S-15MY3E	 S-22MY3E	 S-28MY3E		 S-36MY3E		 S-45MY3E
P. 123	Y2 Type 4 way 60x60 cassette · R32 / R410A	 S-15MY2E5B	 S-22MY2E5B	 S-28MY2E5B		 S-36MY2E5B		 S-45MY2E5B
P. 124	L1 Type 2 way cassette · R410A		 S-22ML1E5	 S-28ML1E5		 S-36ML1E5		 S-45ML1E5
P. 125	D1 Type 1 way cassette · R410A			 S-28MD1E5		 S-36MD1E5		 S-45MD1E5
P. 126	F3 Type variable static pressure adaptive duct · R32	 S-15MF3E5B	 S-22MF3E5B	 S-28MF3E5B		 S-36MF3E5B		 S-45MF3E5B
P. 126	F3 Type variable static pressure adaptive duct · R410A	 S-15MF3E5A	 S-22MF3E5A	 S-28MF3E5A		 S-36MF3E5A		 S-45MF3E5A
P. 127	F2 Type variable static pressure hide-away · R410A	 S-15MF2E5A	 S-22MF2E5A	 S-28MF2E5A		 S-36MF2E5A		 S-45MF2E5A
P. 128	M1 Type slim variable static pressure hide-away · R32 / R410A	 S-15MM1E5B	 S-22MM1E5B	 S-28MM1E5B		 S-36MM1E5B		 S-45MM1E5B
P. 129	E2 Type high static pressure hide-away · R410A							
P. 130	Heat recovery with DX coil · R410A				 PAW-500ZDX3N	 PAW-800ZDX3N	 PAW-01KZDX3N	
P. 131	T2 Type ceiling · R410A					 S-36MT2E5A		 S-45MT2E5A
P. 132	K2 Type wall-mounted · R32 / R410A	 S-15MK2E5B	 S-22MK2E5B	 S-28MK2E5B		 S-36MK2E5B		 S-45MK2E5B
P. 133	G1 Type floor console · R410A		 S-22MG1E5N	 S-28MG1E5N		 S-36MG1E5N		 S-45MG1E5N
P. 134	P1 Type floor-standing · R410A		 S-22MP1E5	 S-28MP1E5		 S-36MP1E5		 S-45MP1E5
P. 134	R1 Type concealed floor-standing · R410A		 S-22MR1E5	 S-28MR1E5		 S-36MR1E5		 S-45MR1E5
P. 135	Hydrokit for ECOi, water at 45 °C · R410A							

OPTIONAL UNITS ON VENTILATION SECTION

5.6 kW	6.0 kW	7.3 kW	9.0 kW	10.6 kW	14.0 kW	16.0 kW	22.4 kW	28.0 kW
 S-56MU2E5B	 S-60MU2E5B	 S-73MU2E5B	 S-90MU2E5B	 S-106MU2E5B	 S-140MU2E5B	 S-160MU2E5B		
 S-56MY3E								
 S-56MY2E5B								
 S-56ML1E5		 S-73ML1E5						
 S-56MD1E5		 S-73MD1E5						
 S-56MF3E5B	 S-60MF3E5B	 S-73MF3E5B	 S-90MF3E5B	 S-106MF3E5B	 S-140MF3E5B	 S-160MF3E5B		
 S-56MF3E5A	 S-60MF3E5A	 S-73MF3E5A	 S-90MF3E5A	 S-106MF3E5A	 S-140MF3E5A	 S-160MF3E5A		
 S-56MF2E5A	 S-60MF2E5A	 S-73MF2E5A	 S-90MF2E5A	 S-106MF2E5A	 S-140MF2E5A	 S-160MF2E5A		
 S-56MM1E5B								
							 S-224ME2E5	 S-280ME2E5
 S-56MT2E5A		 S-73MT2E5A		 S-106MT2E5A	 S-140MT2E5A			
 S-56MK2E5B		 S-73MK2E5B		 S-106MK2E5B				
 S-56MG1E5N								
 S-56MP1E5		 S-71MP1E5						
 S-56MR1E5		 S-71MR1E5						
			 S-80MW1E5	 S-125MW1E5				

Bringing nature's balance indoors



nanoe™ X, technology with the benefits of hydroxyl radicals.

Abundant in nature, hydroxyl radicals (also known as OH radicals) have the capacity to inhibit pollutants, viruses, and bacteria to clean and deodorise. nanoe™ X technology can bring these incredible benefits indoors so that hard surfaces, soft furnishings, and the indoor environment can be a cleaner and more pleasant place to be, whether at home, work, or visiting hotels, shops and restaurants etc.



A naturally occurring process

Hydroxyl radicals are unstable molecules looking to react with other elements like hydrogen, capturing it. Thanks to this reaction, hydroxyl radicals have the potential to inhibit the growth of pollutants such as bacteria, viruses, moulds, and odours, breaking them down and neutralising the unpleasant effects. This naturally occurring process has major benefits to improve indoor environments.

Panasonic's nanoe™ X technology takes this a step further and brings nature's detergent – hydroxyl radicals – indoors to help create an ideal environment

Thanks to the nanoe™ X properties, several types of pollutants can be inhibited such as certain types of bacteria, viruses, mould, allergens, pollen and certain hazardous substances.



1 | nanoe™ X reliably reaches pollutants.

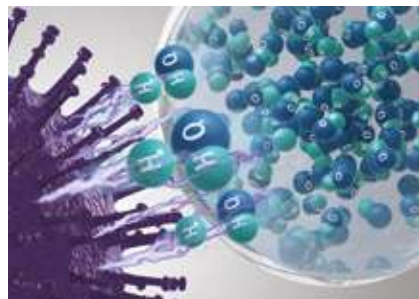

2 | Hydroxyl radicals denature pollutants' proteins.



3 | Pollutants activity is inhibited.

Panasonic Heating & Cooling Solutions is incorporating nanoe™ technology in a wide range of equipment

NEW Built-in nanoe X Generator (TBC).



Y3 Type 4 way 60x60 cassette.
S-**MY3E.
6 capacities: 1.5 - 5.6 kW.



U2 Type 4 way 90x90 cassette.
S-***MU2E5B.
11 capacities: 2.2 - 16.0 kW.



F3 Type adaptive duct.
S-***MF3E5B.
12 capacities: 1.5 - 16.0 kW.



G1 Type floor console.
S-**MG1E5N.
5 capacities: 2.2 - 5.6 kW.



nanoe™ X as a standard.



U2 Type 4 way 90x90 cassette - R32 / R410A

The 4 way 90x90 cassettes with integrated nanoe X Generator Mark 2 and new panel design.

Panasonic introduces a modern flat panel design to blend into any space. These cassettes have been developed to satisfy customer needs such as high energy saving, comfort and better indoor air quality.

COMPATIBLE WITH ALL PANASONIC CONNECTIVITY SOLUTIONS. FOR DETAILED INFORMATION GO TO THE CONTROL SYSTEMS SECTION

Model	S . .MU2E5B	22	28	36	45	56	60	73	90	106	140	160	
Cooling capacity	kW	2.2	2.8	3.6	4.5	5.6	6.0	7.3	9.0	10.6	14.0	16.0	
Input power	W	20.00	20.00	20.00	20.00	25.00	35.00	40.00	40.00	90.00	95.00	105.00	
Current (cool)	A	0.21	0.21	0.21	0.21	0.23	0.33	0.36	0.38	0.71	0.74	0.82	
Heating capacity	kW	2.5	3.2	4.2	5.0	6.3	7.1	8.0	10.0	11.4	16.0	18.0	
Input power	W	20.00	20.00	20.00	20.00	25.00	35.00	40.00	40.00	85.00	90.00	100.00	
Current (heat)	A	0.20	0.20	0.20	0.20	0.22	0.32	0.35	0.37	0.69	0.72	0.80	
Fan type		Turbo fan	Turbo fan	Turbo fan	Turbo fan	Turbo fan	Turbo fan	Turbo fan	Turbo fan	Turbo fan	Turbo fan	Turbo fan	
nanoe X Generator		Mark 2	Mark 2	Mark 2	Mark 2	Mark 2	Mark 2	Mark 2	Mark 2	Mark 2	Mark 2	Mark 2	
Air flow	Hi/Med/Lo	m ³ /sec	0.24/0.22 /0.19	0.24/0.22 /0.19	0.24/0.22 /0.19	0.26/0.22 /0.19	0.28/0.23 /0.19	0.35/0.27 /0.22	0.38/0.27 /0.22	0.38/0.31 /0.23	0.57/0.42 /0.32	0.60/0.43 /0.33	0.62/0.47 /0.40
Sound pressure	Hi/Med/Lo	dB(A)	30/29/28	30/29/28	30/29/28	31/29/28	32/30/28	36/32/29	37/32/29	38/35/32	44/38/34	45/39/35	46/40/38
Sound power	Hi/Med/Lo	dB(A)	45/44/43	45/44/43	45/44/43	46/44/43	47/45/43	51/47/44	52/47/44	53/50/47	59/53/49	60/54/50	61/55/53
Dimension (HxWxD)	Indoor	mm	256 x 840 x 840	256 x 840 x 840	256 x 840 x 840	256 x 840 x 840	256 x 840 x 840	256 x 840 x 840	256 x 840 x 840	256 x 840 x 840	319 x 840 x 840	319 x 840 x 840	319 x 840 x 840
	Panel	mm	33.5 x 950 x 950	33.5 x 950 x 950	33.5 x 950 x 950	33.5 x 950 x 950	33.5 x 950 x 950	33.5 x 950 x 950	33.5 x 950 x 950	33.5 x 950 x 950	33.5 x 950 x 950	33.5 x 950 x 950	33.5 x 950 x 950
Net weight (Panel)	kg	19(5)	19(5)	19(5)	19(5)	19(5)	20(5)	20(5)	20(5)	25(5)	25(5)	25(5)	
Piping diameter	Liquid	Inch (mm)	1/4 (6.35)	1/4 (6.35)	1/4 (6.35)	1/4 (6.35)	1/4 (6.35)	3/8 (9.52) ¹⁾	3/8 (9.52) ¹⁾	3/8 (9.52) ¹⁾	3/8 (9.52)	3/8 (9.52)	3/8 (9.52)
	Gas	Inch (mm)	1/2 (12.70)	1/2 (12.70)	1/2 (12.70)	1/2 (12.70)	1/2 (12.70)	5/8 (15.88) ¹⁾	5/8 (15.88) ¹⁾	5/8 (15.88) ¹⁾	5/8 (15.88)	5/8 (15.88)	5/8 (15.88)
Indoor unit RRP	£	996	1,022	1,058	1,129	1,196	1,219	1,243	1,373	1,491	1,691	1,848	
CZ-KPU3W panel RRP	£	204	204	204	204	204	204	204	204	204	204	204	

1) When the piping diameter is (liquid) Ø1/4 (6.35) - (gas) Ø1/2 (12.70), connect the liquid socket tube (Ø6.35 - Ø9.52) to the liquid tubing side indoor unit and connect the gas socket tube (Ø12.70 - Ø15.88) to the gas tubing side indoor unit. * Above values are in the case of nanoe™ X OFF.

Accessories	RRP £
CZ-RTC6	CONEX wired remote controller (non-wireless) 144
CZ-RTC6BL	CONEX wired remote controller with Bluetooth® 172
CZ-RTC5B	Wired remote controller with Econavi function 144
CZ-RWS3 + CZ-RWRU3W	Infrared remote controller and receiver 276
PAW-RE2C4-MOD-WH	Modbus RS-485 touch room controller with I/O, white 444
PAW-RE2C4-MOD-BK	Modbus RS-485 touch room controller with I/O, black 444
PAW-RE2D4-WH	Touch display control with 2 digital inputs, white 271

Accessories	RRP £
PAW-RE2D4-BK	Touch display control with 2 digital inputs, black 271
CZ-KPU3W	Standard panel 204
CZ-KPU3AW	Econavi exclusive panel 278
CZ-CENSC1	Econavi energy savings sensor 151
CZ-FDU3+CZ-ATU2	Fresh air-intake kit 786
CZ-CGLSC1	Panasonic R32 refrigerant leak detector 160

Technical focus

- High performance turbo fan
- Lower noise in slow fan operation
- Ceiling height up to 5.0 m
- Industry leading lightweight design
- Econavi: Temperature, humidity and activity sensor
- nanoe™ X (Generator Mark 2= 9.6 trillion hydroxyl radicals/sec) as standard for better indoor air quality, indoor unit internal cleaning with nanoe™ X and dry operation
- Powerful drain pump gives 850 mm lift
- Fresh air knockout
- Branch duct connection
- High volume fresh air input with optional air-intake plenum and chamber (CZ-FDU3+CZ-ATU2)

Panel design

Flat design, well-matched with interior.
4-way individual flap control.

The drain pipe can be raised to a maximum height of 850 mm from the bottom of the ceiling

Integrated drain pump allows a drain height of 850 mm making the installation much easier.

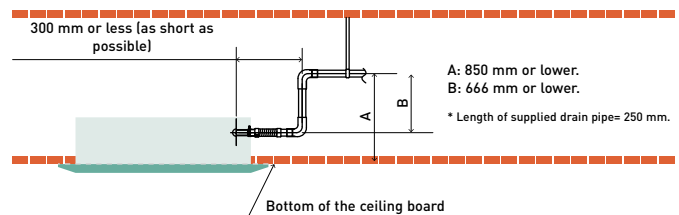

ECONAVI and INTERNET CONTROL: Optional.

Rating Conditions: Cooling Indoor 27 °C DB / 19 °C WB. Cooling Outdoor 35 °C DB / 24 °C WB. Heating Indoor 20 °C DB. Heating Outdoor 7 °C DB / 6 °C WB. (DB: Dry Bulb; WB: Wet Bulb). Specifications subject to change without notice. For detailed information about ErP / Energy Labelling, please visit our websites www.panasonic.co.uk/aircon or www.ptc.panasonic.eu.

NEW
2022

nanoe™ X
nanoe™ X as a standard.

NEW Y3 Type 4 way 60x60 cassette - R32 / R410A

New mini cassette with a modern panel design is available in VRF range.

The Y3 Type not only perfectly matches with 600 x 600 mm ceiling grids but also provides the additional benefits of nanoe™ X, for better indoor air quality.

COMPATIBLE WITH ALL PANASONIC CONNECTIVITY SOLUTIONS. FOR DETAILED INFORMATION GO TO THE CONTROL SYSTEMS SECTION

Model		S-15MY3E	S-22MY3E	S-28MY3E	S-36MY3E	S-45MY3E	S-56MY3E
Cooling capacity	kW	1.5	2.2	2.8	3.6	4.5	5.6
Input power	W	35.00	35.00	35.00	40.00	40.00	45.00
Current	A	0.30	0.30	0.30	0.30	0.32	0.35
Heating capacity	kW	1.7	2.5	3.2	4.2	5.0	6.3
Input power	W	30.00	30.00	30.00	35.00	35.00	40.00
Current	A	0.25	0.25	0.30	0.30	0.30	0.30
Fan type		Centrifugal fan	Centrifugal fan	Centrifugal fan	Centrifugal fan	Centrifugal fan	Centrifugal fan
Air flow	Cool (Hi / Med / Lo)	m³/sec	0.15/0.14/0.09	0.15/0.14/0.09	0.16/0.14/0.09	0.16/0.15/0.10	0.17/0.16/0.14
	Heat (Hi / Med / Lo)	m³/sec	0.15/0.14/0.09	0.16/0.14/0.09	0.16/0.15/0.09	0.17/0.15/0.10	0.17/0.16/0.14
Sound pressure	Hi / Med / Lo	dB(A)	34/31/25	35/31/25	35/31/25	36/32/26	38/34/28
Sound power	Hi / Med / Lo	dB(A)	49/46/40	50/46/40	50/46/40	51/47/41	53/49/43
Dimension (H x W x D) ¹⁾	Indoor	mm	230x575x575	230x575x575	230x575x575	230x575x575	230x575x575
	Panel AW	mm	41x625x625	41x625x625	41x625x625	41x625x625	41x625x625
Net weight		kg	17.8(15+2.8)	17.8(15+2.8)	17.8(15+2.8)	17.8(15+2.8)	17.8(15+2.8)
Piping diameter	Liquid pipe	Inch (mm)	1/4(6.35)	1/4(6.35)	1/4(6.35)	1/4(6.35)	1/4(6.35)
	Gas pipe	Inch (mm)	1/2(12.70)	1/2(12.70)	1/2(12.70)	1/2(12.70)	1/2(12.70)
Indoor unit RRP	£	904	929	955	979	1.060	1.173
CZ-KPY4 panel RRP	£	233	233	233	233	233	233

1) Unit height is 230mm, but need 243mm height in ceiling space for its installation. * Available in Autumn 2022.

Accessories	RRP £
CZ-RTC6 CONEX wired remote controller (non-wireless)	144
CZ-RTC6BL CONEX wired remote controller with Bluetooth®	172
CZ-RTC5B Wired remote controller with Econavi function	144
CZ-RWS3 + CZ-RWR3 Infrared remote controller and receiver	
PAW-RE2C4-MOD-WH Modbus RS-485 touch room controller with I/O, white	444

Accessories	RRP £
PAW-RE2C4-MOD-BK Modbus RS-485 touch room controller with I/O, black	444
PAW-RE2D4-WH Touch display control with 2 digital inputs, white	271
PAW-RE2D4-BK Touch display control with 2 digital inputs, black	271
CZ-CENSC1 Econavi energy savings sensor	151
CZ-CGLSC1 Panasonic R32 refrigerant leak detector	160

Compact and stylish design

- Ceiling depth is only 250 mm
- Exposed area is only 30 mm

Technical focus

- Built-in drain pump
- DC drain pump and float switch to reduce the noise
- nanoe™ X as standard for better indoor air quality
- Self cleaning inside of the unit with nanoe™ X

Individual flap control

Better control of the air flow with 4 motors, providing individual flap control. Perfect air distribution without direct airflow, to reduce the feeling of cold drafts.

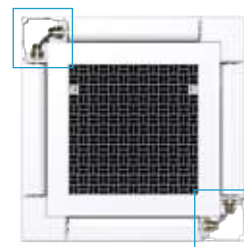

ECONAVI and INTERNET CONTROL: Optional.



Y2 Type 4 way 60x60 cassette - R32 / R410A

Designed to fit exactly into a 600 x 600 mm ceiling grid without the need to alter the bar configuration.

The Y2 is ideal for small commercial and retrofit applications. In addition, the improvements to efficiency make this one of the most advanced units in the industry.

COMPATIBLE WITH ALL PANASONIC CONNECTIVITY SOLUTIONS. FOR DETAILED INFORMATION GO TO THE CONTROL SYSTEMS SECTION

Model		S-15MY2E5B	S-22MY2E5B	S-28MY2E5B	S-36MY2E5B	S-45MY2E5B	S-56MY2E5B
Cooling capacity	kW	1.5	2.2	2.8	3.6	4.5	5.6
Input power	W	35.00	35.00	35.00	40.00	40.00	45.00
Current	A	0.30	0.30	0.30	0.30	0.32	0.35
Heating capacity	kW	1.7	2.5	3.2	4.2	5.0	6.3
Input power	W	30.00	30.00	30.00	35.00	35.00	40.00
Current	A	0.25	0.25	0.30	0.30	0.30	0.30
Fan type		Centrifugal fan	Centrifugal fan	Centrifugal fan	Centrifugal fan	Centrifugal fan	Centrifugal fan
Air flow	Cool (Hi / Med / Lo)	m³/sec	0.15/0.14/0.09	0.15/0.14/0.09	0.16/0.14/0.09	0.16/0.15/0.10	0.17/0.16/0.14
	Heat (Hi / Med / Lo)	m³/sec	0.15/0.14/0.09	0.16/0.14/0.09	0.16/0.15/0.09	0.17/0.15/0.10	0.17/0.16/0.14
Sound pressure	Hi / Med / Lo	dB(A)	34/31/25	35/31/25	35/31/25	36/32/26	38/34/28
	Hi / Med / Lo	dB(A)	49/46/40	50/46/40	50/46/40	51/47/41	53/49/43
Dimension (H x W x D)	Indoor	mm	288 x 583 x 583	288 x 583 x 583	288 x 583 x 583	288 x 583 x 583	288 x 583 x 583
	Panel AW	mm	31 x 700 x 700	31 x 700 x 700	31 x 700 x 700	31 x 700 x 700	31 x 700 x 700
	Panel BW	mm	31 x 625 x 625	31 x 625 x 625	31 x 625 x 625	31 x 625 x 625	31 x 625 x 625
Net weight	kg	20.4 (18 + 2.4)	20.4 (18 + 2.4)	20.4 (18 + 2.4)	20.4 (18 + 2.4)	20.4 (18 + 2.4)	20.4 (18 + 2.4)
Piping diameter	Liquid pipe	Inch (mm)	1/4 (6.35)	1/4 (6.35)	1/4 (6.35)	1/4 (6.35)	1/4 (6.35)
	Gas pipe	Inch (mm)	1/2 (12.70)	1/2 (12.70)	1/2 (12.70)	1/2 (12.70)	1/2 (12.70)
Indoor unit RRP	£	888	912	938	961	1.040	1.152
CZ-KPY3AW / CZ-KPY3BW panel RRP	£	233 / 224	233 / 224	233 / 224	233 / 224	233 / 224	233 / 224

Accessories		RRP £
CZ-RTC6	CONEX wired remote controller (non-wireless)	144
CZ-RTC6BL	CONEX wired remote controller with Bluetooth®	172
CZ-RTC5B	Wired remote controller with Econavi function	144
CZ-RWS3	Infrared remote controller	108
PAW-RE2C4-MOD-WH	Modbus RS-485 touch room controller with I/O, white	444
PAW-RE2C4-MOD-BK	Modbus RS-485 touch room controller with I/O, black	444

Accessories		RRP £
PAW-RE2D4-WH	Touch display control with 2 digital inputs, white	271
PAW-RE2D4-BK	Touch display control with 2 digital inputs, black	271
CZ-KPY3AW	Panel 700 x 700 mm	233
CZ-KPY3BW	Panel 625 x 625 mm	224
CZ-CENSC1	Econavi energy savings sensor	151
CZ-CGLSC1	Panasonic R32 refrigerant leak detector	160

Technical focus

- Mini cassette fits into a 600 x 600 mm ceiling grid
- Optimised air distribution
- Multidirectional air flow
- Powerful drain pump gives 750 mm lift
- Variable speed DC fan motors and optimised heat exchanger to maximize efficiency

A drain height of approximately 750 mm from the ceiling surface

The drain height can be increased by approximately 350 mm over the conventional value by using a high-lift drain pump, and long horizontal piping is possible. A lightweight unit at 18.4 kg the unit is also very slim with a height of only 288 mm, making installation possible even in narrow ceilings.

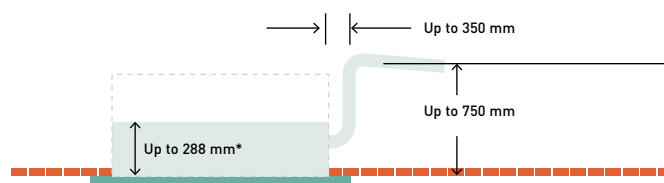

ECONAVI and INTERNET CONTROL: Optional.

Rating Conditions: Cooling Indoor 27 °C DB / 19 °C WB. Cooling Outdoor 35 °C DB / 24 °C WB. Heating Indoor 20 °C DB. Heating Outdoor 7 °C DB / 6 °C WB. [DB: Dry Bulb; WB: Wet Bulb]. Specifications subject to change without notice. For detailed information about ErP / Energy Labelling, please visit our websites www.panasonic.co.uk/aircon or www.ptc.panasonic.eu.

L1 Type 2 way cassette - R410A

Slim, compact and lightweight units.

Remarkable size and weight reductions have been achieved by improvement of the design around the fan, the weight of all models now being 30 kg.



COMPATIBLE WITH ALL PANASONIC CONNECTIVITY SOLUTIONS. FOR DETAILED INFORMATION GO TO THE CONTROL SYSTEMS SECTION

Model		S-22ML1E5	S-28ML1E5	S-36ML1E5	S-45ML1E5	S-56ML1E5	S-73ML1E5
Cooling capacity	kW	2.2	2.8	3.6	4.5	5.6	7.3
Input power	W	90.00	92.00	93.00	97.00	97.00	145.00
Current	A	0.45	0.45	0.45	0.45	0.45	0.65
Heating capacity	kW	2.5	3.2	4.2	5.0	6.3	8.0
Input power	W	58.00	60.00	61.00	65.00	65.00	109.00
Current	A	0.29	0.29	0.29	0.29	0.29	0.48
Fan type		Sirocco fan	Sirocco fan	Sirocco fan	Sirocco fan	Sirocco fan	Sirocco fan
Air flow	Hi / Med / Lo	m ³ /sec	0.13/0.12/0.10	0.15/0.13/0.12	0.16/0.15/0.13	0.18/0.15/0.13	0.32/0.27/0.23
Sound pressure	Hi / Med / Lo	dB(A)	30/27/24	33/29/26	34/31/28	35/33/29	38/35/33
Dimension (H x W x D)	Indoor	mm	350 x 840 x 600	350 x 840 x 600	350 x 840 x 600	350 x 840 x 600	350 x 1140 x 600
	Panel	mm	8 x 1060 x 680	8 x 1060 x 680	8 x 1060 x 680	8 x 1060 x 680	8 x 1360 x 680
Net weight (Panel)		kg	26.0(8.0)	26.0(8.0)	26.0(8.0)	26.0(8.0)	26.0(8.0)
Piping diameter	Liquid pipe	Inch (mm)	1/4(6.35)	1/4(6.35)	1/4(6.35)	1/4(6.35)	3/8(9.52)
	Gas pipe	Inch (mm)	1/2(12.70)	1/2(12.70)	1/2(12.70)	1/2(12.70)	5/8(15.88)
Indoor unit RRP	£	1.204	1.230	1.303	1.504	1.542	1.598
CZ-02KPL2 panel RRP	£	362	362	362	362	362	—
CZ-03KPL2 panel RRP	£	—	—	—	—	—	431

Accessories		RRP £
CZ-RTC6	CONEX wired remote controller (non-wireless)	144
CZ-RTC6BL	CONEX wired remote controller with Bluetooth®	172
CZ-RTC5B	Wired remote controller with Econavi function	144
CZ-RWS3 + CZ-RWRL3	Infrared remote controller and receiver	276
PAW-RE2C4-MOD-WH	Modbus RS-485 touch room controller with I/O, white	444

Accessories		RRP £
PAW-RE2C4-MOD-BK	Modbus RS-485 touch room controller with I/O, black	444
PAW-RE2D4-WH	Touch display control with 2 digital inputs, white	271
PAW-RE2D4-BK	Touch display control with 2 digital inputs, black	271
CZ-02KPL2	Panel for S-22 to S-56 models	362
CZ-03KPL2	Panel for S-73 model	431

Technical focus

- Air flow and distribution is automatically altered depending on the operational mode of the unit
- Drain pump provides up to 500 mm lift height
- Simple maintenance

Simple maintenance

The drain pan is equipped with site wiring and can be removed. The fan case has a split construction, and the fan motor can be removed easily when the lower case is removed.

Auto flap control

Air flow and distribution is automatically altered depending on the operational mode of the unit.

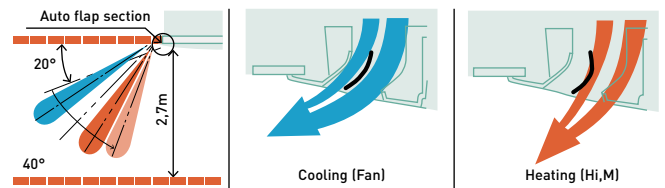

Drain pump provides up to 500 mm lift height

Maintenance of the drain pump is possible from two sides, from the left side (piping side) and from the inside of the unit.

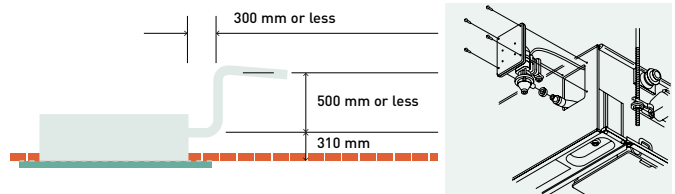

INTERNET CONTROL: Optional.



D1 Type 1 way cassette · R410A

Designed for installation within the ceiling void, the D1 range of slimline 1 way blow cassettes feature powerful yet quiet fans for up to 4.2 m.

COMPATIBLE WITH ALL PANASONIC CONNECTIVITY SOLUTIONS. FOR DETAILED INFORMATION GO TO THE CONTROL SYSTEMS SECTION

Model		S-28MD1E5	S-36MD1E5	S-45MD1E5	S-56MD1E5	S-73MD1E5	
Cooling capacity	kW	2.8	3.6	4.5	5.6	7.3	
Input power	W	51.00	51.00	51.00	60.00	87.00	
Current	A	0.39	0.39	0.39	0.46	0.70	
Heating capacity	kW	3.2	4.2	5.0	6.3	8.0	
Input power	W	40.00	40.00	40.00	48.00	76.00	
Current	A	0.35	0.35	0.35	0.41	0.65	
Fan type		Sirocco fan	Sirocco fan	Sirocco fan	Sirocco fan	Sirocco fan	
Air flow	Hi / Med / Lo	m ³ /sec	0.20/0.17/0.15	0.20/0.17/0.15	0.20/0.18/0.17	0.22/0.19/0.17	0.30/0.25/0.22
Sound pressure	Hi / Med / Lo	dB(A)	36/34/33	36/34/33	36/35/34	38/36/34	45/40/36
Dimension (HxWxD)	Indoor	mm	200x1000x710	200x1000x710	200x1000x710	200x1000x710	200x1000x710
	Panel	mm	20x1230x800	20x1230x800	20x1230x800	20x1230x800	20x1230x800
Net weight (Panel)		kg	23.5(7.5)	23.5(7.5)	23.5(7.5)	23.5(7.5)	24.5(7.5)
Piping diameter	Liquid pipe	Inch (mm)	1/4(6.35)	1/4(6.35)	1/4(6.35)	1/4(6.35)	3/8(9.52)
	Gas pipe	Inch (mm)	1/2(12.70)	1/2(12.70)	1/2(12.70)	1/2(12.70)	5/8(15.88)
Indoor unit RRP	£	1.310	1.386	1.441	1.475	1.641	
CZ-KPD2 panel RRP	£	381	381	381	381	381	

Accessories		RRP £
CZ-RTC6	CONEX wired remote controller (non-wireless)	144
CZ-RTC6BL	CONEX wired remote controller with Bluetooth®	172
CZ-RTC5B	Wired remote controller with Econavi function	144
CZ-RWS3 + CZ-RWRD3	Infrared remote controller and receiver	276
PAW-RE2C4-MOD-WH	Modbus RS-485 touch room controller with I/O, white	444

Accessories		RRP £
PAW-RE2C4-MOD-BK	Modbus RS-485 touch room controller with I/O, black	444
PAW-RE2D4-WH	Touch display control with 2 digital inputs, white	271
PAW-RE2D4-BK	Touch display control with 2 digital inputs, black	271
CZ-KPD2	Panel	381

Technical focus

- Ultra-Slim
- Suitable for standard and high ceilings
- Built-in drain pump provides 590 mm lift
- Easy to install and maintain
- Hanging height can be easily adjusted
- Uses a DC fan motor to improve energy-efficiency

Drain height

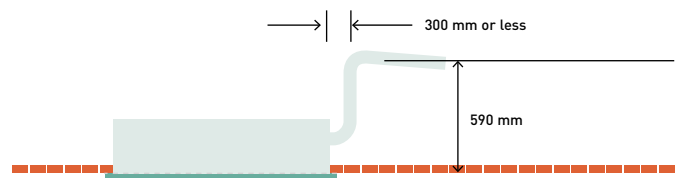

With 3 types of air-blow systems, the units can be used in various ways



1. One-direction "down-blow" system.

Powerful one-direction "down-blow" system reaches the floor even from high ceilings (up to 4.2 m).



2. Two-direction ceiling-mounted system.

"Down-blow" and "front-blow" systems are combined in a ceiling-mounted unit to blow air over a wide area.



3. One-direction ceiling-mounted system.

This powerful ceiling-mounted "front-blow" system efficiently air-conditions the space in front of the unit. [Additional accessories required].



INTERNET CONTROL: Optional.

Rating Conditions: Cooling Indoor 27 °C DB / 19 °C WB. Cooling Outdoor 35 °C DB / 24 °C WB. Heating Indoor 20 °C DB. Heating Outdoor 7 °C DB / 6 °C WB. [DB: Dry Bulb; WB: Wet Bulb]. Specifications subject to change without notice. For detailed information about ErP / Energy Labelling, please visit our websites www.panasonic.co.uk/aircon or www.ptc.panasonic.eu.



nanoe™ X
nanoe™ X as a standard.

F3 Type variable static pressure adaptive duct - R32 / R410A

Design adaptive ducted F3 range.

2 installation possibilities (horizontal / vertical) with high ESP 150 Pa allows for flexible installation.

COMPATIBLE WITH ALL PANASONIC CONNECTIVITY SOLUTIONS. FOR DETAILED INFORMATION GO TO THE CONTROL SYSTEMS SECTION

R32 model	S . .MF3E5B	15	22	28	36	45	56	60	73	90	106	140	160	
R410A model	S . .MF3E5A	15	22	28	36	45	56	60	73	90	106	140	160	
Cooling capacity	kW	1.5	2.2	2.8	3.6	4.5	5.6	6.0	7.3	9.0	10.6	14.0	16.0	
Input power	W	60.00	60.00	60.00	60.00	60.00	89.00	79.00	79.00	136.00	146.00	265.00	330.00	
Current (cool)	A	0.45	0.45	0.45	0.45	0.45	0.63	0.52	0.52	0.90	1.00	1.76	2.14	
Heating capacity	kW	1.7	2.5	3.2	4.2	5.0	6.3	7.1	8.0	10.0	11.4	16.0	18.0	
Input power	W	60.00	60.00	60.00	60.00	60.00	89.00	79.00	79.00	136.00	146.00	265.00	330.00	
Current (heat)	A	0.45	0.45	0.45	0.45	0.45	0.63	0.52	0.52	0.90	1.00	1.76	2.14	
R32 leakage sensors ¹⁾		2	2	2	2	2	2	2	2	2	2	2	2	
Fan type		Sirocco fan	Sirocco fan	Sirocco fan	Sirocco fan	Sirocco fan	Sirocco fan	Sirocco fan	Sirocco fan	Sirocco fan	Sirocco fan	Sirocco fan	Sirocco fan	
nanoe X Generator		Mark 2	Mark 2	Mark 2	Mark 2	Mark 2	Mark 2	Mark 2	Mark 2	Mark 2	Mark 2	Mark 2	Mark 2	
Air flow ²⁾	Hi/Med/Lo	m ³ /sec	0.23/0.20 /0.13	0.23/0.20 /0.13	0.23/0.20 /0.13	0.23/0.20 /0.13	0.23/0.20 /0.13	0.27/0.23 /0.17	0.35/0.30 /0.25	0.35/0.30 /0.25	0.42/0.38 /0.27	0.53/0.43 /0.35	0.62/0.53 /0.43	0.67/0.57 /0.47
External static pressure	Pa		30 (10-150)	30 (10-150)	30 (10-150)	30 (10-150)	30 (10-150)	30 (10-150)	30 (10-150)	30 (10-150)	40 (10-150)	40 (10-150)	50 (10-150)	50 (10-150)
Sound pressure	Hi/Med/Lo	dB(A)	31/28/20	31/28/20	31/28/20	31/28/20	31/28/20	35/32/24	31/28/23	31/28/23	35/33/25	36/32/27	41/36/32	43/37/33
Sound power	Hi/Med/Lo	dB(A)	54/51/43	54/51/43	54/51/43	54/51/43	54/51/43	58/55/47	54/51/46	54/51/46	58/56/48	59/55/50	64/59/55	66/60/56
Dimension	HxWxD	mm	250x800 x730	250x800 x730	250x800 x730	250x800 x730	250x800 x730	250x800 x730	250x1000 x730	250x1000 x730	250x1000 x730	250x1400 x730	250x1400 x730	250x1400 x730
Net weight	kg		26	26	26	26	26	26	31	31	31	40	40	40
Piping diameter	Liquid	Inch (mm)	1/4 (6.35)	1/4 (6.35)	1/4 (6.35)	1/4 (6.35)	1/4 (6.35)	1/4 (6.35)	1/4 (6.35)	1/4 (6.35)	1/4 (6.35)	3/8 (9.52)	3/8 (9.52)	3/8 (9.52)
R32 model	Gas	Inch (mm)	1/2 (12.70)	1/2 (12.70)	1/2 (12.70)	1/2 (12.70)	1/2 (12.70)	1/2 (12.70)	1/2 (12.70)	1/2 (12.70)	1/2 (12.70)	5/8 (15.88)	5/8 (15.88)	5/8 (15.88)
Piping diameter	Liquid	Inch (mm)	1/4 (6.35)	1/4 (6.35)	1/4 (6.35)	1/4 (6.35)	1/4 (6.35)	1/4 (6.35)	3/8 (9.52)	3/8 (9.52)	3/8 (9.52)	3/8 (9.52)	3/8 (9.52)	3/8 (9.52)
R410A model	Gas	Inch (mm)	1/2 (12.70)	1/2 (12.70)	1/2 (12.70)	1/2 (12.70)	1/2 (12.70)	1/2 (12.70)	5/8 (15.88)	5/8 (15.88)	5/8 (15.88)	5/8 (15.88)	5/8 (15.88)	5/8 (15.88)
R32 model RRP	£		1.160	1.234	1.260	1.284	1.336	1.386	1.507	1.544	1.620	1.814	1.922	2.085
R410A model RRP	£		936	1.005	1.029	1.051	1.100	1.145	1.257	1.292	1.360	1.540	1.639	1.790

1) Only available in the R32 version. 2) Value referred to standard settings at shipment (H curve 8, M curve 5, L curve 1).

Accessories		RRP £
CZ-RTC6	CONEX wired remote controller (non-wireless)	144
CZ-RTC6BL	CONEX wired remote controller with Bluetooth®	172
CZ-RTC5B	Wired remote controller with Econavi function	144
CZ-RW53 + CZ-RWRC3	Infrared remote controller and receiver	276
PAW-RE2C4-MOD-WH	Modbus RS-485 touch room controller with I/O, white	444

Accessories		RRP £
PAW-RE2C4-MOD-BK	Modbus RS-485 touch room controller with I/O, black	444
PAW-RE2D4-WH	Touch display control with 2 digital inputs, white	271
PAW-RE2D4-BK	Touch display control with 2 digital inputs, black	271
CZ-CENSC1	Econavi energy savings sensor	151
CZ-CGLSC1	Panasonic R32 refrigerant leak detector	160

Technical focus

- 4 installation possibilities with horizontal and vertical mounting, plus selectable rear or bottom air inlet
- Industry leading low noise with super quiet operation, minimum 22 dB(A)
- Only 250 mm height and lightweight unit from, 26 to 42 kg
- Integrated Panasonic R32 refrigerant leak detectors ¹⁾
- Improved drain pan suitable for both horizontal / vertical installation
- Drain pump included ²⁾
- nanoe™ X (Generator Mark 2= 9.6 trillion hydroxyl radicals/sec) as standard, effective even at duct connections up to 10 m and 3 bends ³⁾

1) Only available in the R32 version.
2) For use with horizontal installation only
3) Panasonic internal survey.

Vertical Installation

Vertical installation option. Variable external static pressure to support ducted installations with bends.

* Vertical installation requires additional settings on field, please check the installation manual.



Improved drain pan design

Drain pan is shared in both cases horizontal and vertical installation. No need to modify the unit.

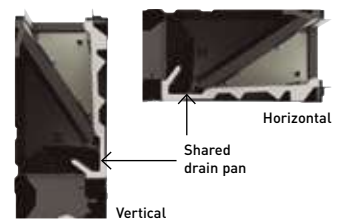

ECONAVI and INTERNET CONTROL: Optional.



F2 Type variable static pressure hide-away · R410A

The F2 type is designed specifically for applications requiring fixed square ducting.

The internal filter is equipped as standard.

COMPATIBLE WITH ALL PANASONIC CONNECTIVITY SOLUTIONS. FOR DETAILED INFORMATION GO TO THE CONTROL SYSTEMS SECTION

Model	S . MF2E5A	15	22	28	36	45	56	60	73	90	106	140	160
Cooling capacity	kW	1.5	2.2	2.8	3.6	4.5	5.6	6.0	7.3	9.0	10.6	14.0	16.0
Input power	W	70.00	70.00	70.00	70.00	70.00	100.00	120.00	120.00	135.00	195.00	215.00	225.00
Current (cool)	A	0.57	0.57	0.57	0.57	0.57	0.74	0.89	0.89	0.97	1.30	1.44	1.50
Heating capacity	kW	1.7	2.5	3.2	4.2	5.0	6.3	7.1	8.0	10.0	11.4	16.0	18.0
Input power	W	70.00	70.00	70.00	70.00	70.00	100.00	120.00	120.00	135.00	200.00	210.00	225.00
Current (heat)	A	0.57	0.57	0.57	0.57	0.57	0.74	0.89	0.89	0.97	1.34	1.42	1.50
Fan type		Sirocco fan	Sirocco fan	Sirocco fan	Sirocco fan	Sirocco fan	Sirocco fan	Sirocco fan	Sirocco fan	Sirocco fan	Sirocco fan	Sirocco fan	Sirocco fan
Air flow ¹⁾	Hi / Med / Lo m ³ /sec	0.23/0.22 /0.15	0.23/0.22 /0.15	0.23/0.22 /0.15	0.23/0.22 /0.15	0.23/0.22 /0.17	0.27/0.25 /0.20	0.35/0.32 /0.25	0.35/0.32 /0.25	0.42/0.38 /0.32	0.53/0.43 /0.35	0.57/0.48 /0.38	0.60/0.53 /0.42
External static pressure	Pa	70(10-150)	70(10-150)	70(10-150)	70(10-150)	70(10-150)	70(10-150)	70(10-150)	70(10-150)	70(10-150)	100(10-150)	100(10-150)	100(10-150)
Sound pressure / power	Hi / Med / Lo dB(A)	33/29/22 /55/51/44	33/29/22 /55/51/44	33/29/22 /55/51/44	33/29/22 /55/51/44	34/32/25 /56/54/47	34/32/25 /56/54/47	35/32/26 /57/54/48	35/32/26 /57/54/48	37/34/28 /59/56/50	38/34/31 /60/56/53	39/35/32 /61/57/54	40/36/33 /62/58/55
Dimension	HxWxD mm	290x800 x700	290x800 x700	290x800 x700	290x800 x700	290x800 x700	290x800 x700	290x1000 x700	290x1000 x700	290x1000 x700	290x1400 x700	290x1400 x700	290x1400 x700
Net weight	kg	29	29	29	29	29	29	34	34	34	46	46	46
Piping diameter	Liquid Inch (mm)	1/4(6.35)	1/4(6.35)	1/4(6.35)	1/4(6.35)	1/4(6.35)	1/4(6.35)	3/8(9.52)	3/8(9.52)	3/8(9.52)	3/8(9.52)	3/8(9.52)	3/8(9.52)
	Gas Inch (mm)	1/2(12.70)	1/2(12.70)	1/2(12.70)	1/2(12.70)	1/2(12.70)	1/2(12.70)	5/8(15.88)	5/8(15.88)	5/8(15.88)	5/8(15.88)	5/8(15.88)	5/8(15.88)
RRP	£	900	922	942	1.011	1.057	1.101	1.208	1.221	1.309	1.480	1.577	1.721

1) Value referred to standard settings at shipment (H curve 8, M curve 5, L curve 1).

Accessories		RRP £
CZ-RTC6	CONEX wired remote controller (non-wireless)	144
CZ-RTC6BL	CONEX wired remote controller with Bluetooth®	172
CZ-RTC5B	Wired remote controller with Econavi function	144
CZ-RWS3 + CZ-RWRC3	Infrared remote controller and receiver	276
PAW-RE2C4-MOD-WH	Modbus RS-485 touch room controller with I/O, white	444

Accessories		RRP £
PAW-RE2C4-MOD-BK	Modbus RS-485 touch room controller with I/O, black	444
PAW-RE2D4-WH	Touch display control with 2 digital inputs, white	271
PAW-RE2D4-BK	Touch display control with 2 digital inputs, black	271
CZ-CENSC1	Econavi energy savings sensor	151

Technical focus

- Industry-leading low sound levels from 25 dB(A)
- Built-in drain pump provides 785 mm lift
- Easy to install and maintain
- Air OFF sensor avoids cold air dumping
- Configurable air temperature control

More powerful drain pump

Using a high-lift drain pump, drain piping can be elevated to 700 mm from the base of the unit.

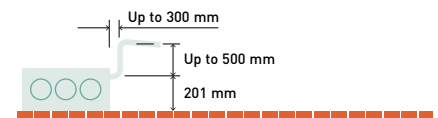

F2 Advantages

Automatic learning function for the required static pressure, to be activated easily by the standard wired timer remote controller. Possible to increase the sensible cooling capacity by adjusting the air flow in order to almost completely eliminate latent losses. This is possible due to the outstanding big heat exchanger surface in combination with increasing the air flow by a manual selection of higher fan speed curves through the standard wired remote controller when commissioning the system together with the default active off-coil temperature control and the room load based variable evaporation temperature control.



ECONAVI and INTERNET CONTROL: Optional.

Diagram 1 S-22MF2E5A

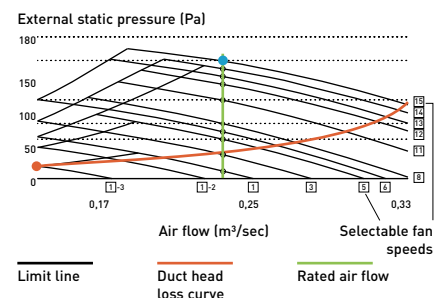

M1 Type slim variable static pressure hide-away concealed duct · R32 / R410A

The ultra slim M1 type is one of the leading products of its type in the industry.

With a depth of only 200 mm it provides greater flexibility and can be used in far more applications.

COMPATIBLE WITH ALL PANASONIC CONNECTIVITY SOLUTIONS. FOR DETAILED INFORMATION GO TO THE CONTROL SYSTEMS SECTION



Model		S-15MM1E5B	S-22MM1E5B	S-28MM1E5B	S-36MM1E5B	S-45MM1E5B	S-56MM1E5B	
Cooling capacity	kW	1.5	2.2	2.8	3.6	4.5	5.6	
Input power	W	36.00	36.00	40.00	42.00	49.00	64.00	
Current	A	0.26	0.26	0.30	0.31	0.37	0.48	
Heating capacity	kW	1.7	2.5	3.2	4.2	5.0	6.3	
Input power	W	26.00	26.00	30.00	32.00	39.00	54.00	
Current	A	0.23	0.23	0.27	0.28	0.34	0.45	
Fan type		Sirocco fan	Sirocco fan	Sirocco fan	Sirocco fan	Sirocco fan	Sirocco fan	
Air flow	Hi / Med / Lo	m ³ /sec	0.13/0.12/0.10	0.13/0.12/0.10	0.14/0.13/0.11	0.15/0.13/0.12	0.18/0.16/0.13	0.21/0.19/0.17
External static pressure		Pa	10(30)	10(30)	15(30)	15(40)	15(40)	
Sound pressure	Hi / Med / Lo ¹⁾	dB(A)	28/27/25 (30/29/27)	28/27/25 (30/29/27)	30/29/27 (32/31/29)	32/30/28 (34/32/30)	34/32/30 (36/34/32)	35/33/31 (37/35/32)
Sound power	Hi / Med / Lo	dB(A)	43/42/40	43/42/40	45/44/42	47/45/43	49/47/45	50/48/46
Dimension	H x W x D	mm	200 x 750 x 640	200 x 750 x 640	200 x 750 x 640	200 x 750 x 640	200 x 750 x 640	
Net weight		kg	19	19	19	19	19	
Piping diameter	Liquid pipe	Inch (mm)	1/4(6.35)	1/4(6.35)	1/4(6.35)	1/4(6.35)	1/4(6.35)	
	Gas pipe	Inch (mm)	1/2(12.70)	1/2(12.70)	1/2(12.70)	1/2(12.70)	1/2(12.70)	
RRP	£	870	879	906	944	983	1,029	

1) By DIP switches or by RC setting.

Accessories		RRP £
CZ-RTC6	CONEX wired remote controller (non-wireless)	144
CZ-RTC6BL	CONEX wired remote controller with Bluetooth®	172
CZ-RTC5B	Wired remote controller with Econavi function	144
CZ-RWS3 + CZ-RWRC3	Infrared remote controller and receiver	276
PAW-RE2C4-MOD-WH	Modbus RS-485 touch room controller with I/O, white	444

Accessories		RRP £
PAW-RE2C4-MOD-BK	Modbus RS-485 touch room controller with I/O, black	444
PAW-RE2D4-WH	Touch display control with 2 digital inputs, white	271
PAW-RE2D4-BK	Touch display control with 2 digital inputs, black	271
CZ-CENSC1	Econavi energy savings sensor	151
CZ-CGLSC1	Panasonic R32 refrigerant leak detector	160

Technical focus

- Ultra-slim profile: 200 mm for all models
- DC fan motor greatly reduces power consumption
- Ideal for hotel application with very narrow false ceilings
- Easy maintenance and service by external electrical box
- Up to 40 Pa static pressure enables ductwork to be fitted
- Includes drain pump

Air outlet and inlet plenum

	Diameters	Air outlet plenum	Diameters	Air inlet plenum
22, 28 and 36	2 x Ø200	CZ-DUMPA22MMS2	2 x Ø200	CZ-DUMPA22MMR2
45 and 56	3 x Ø160	CZ-DUMPA45MMS3	2 x Ø200	CZ-DUMPA22MMR2

* Plenums installed with an R32 Mini ECOi system may only be used when no Panasonic R32 refrigerant leak detector is required. Please refer to technical data manual for refrigerant installation requirements.

Drain pump with increased power!

By adoption of a high-lift drain pump, the drain piping can achieve up to 500 mm lift from the outlet port of the unit.

In addition, its high-efficiency and extremely quiet sound levels make it very popular with many users, including hotels and small offices.

Ultra-slim profile for all models

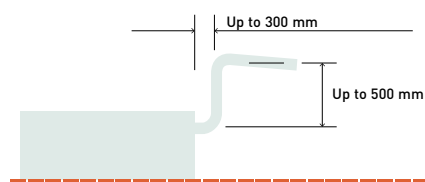
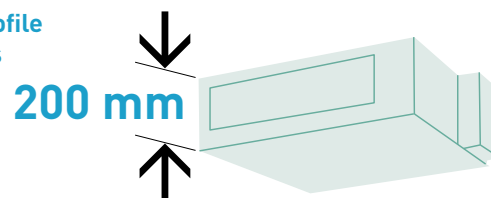

ECONAVI and INTERNET CONTROL: Optional.



E2 Type high static pressure hide-away · R410A

High pressure duct and 100 % fresh air duct function.

The E2 range of ducted units offers improved design flexibility for extended duct layouts as a result of their increased external static pressures and reduces energy consumption, while providing fresh air to larger spaces.

COMPATIBLE WITH ALL PANASONIC CONNECTIVITY SOLUTIONS. FOR DETAILED INFORMATION GO TO THE CONTROL SYSTEMS SECTION

Model	100 % fresh air duct function (by using kit for 100 % fresh air)				High pressure duct							
	S-224ME2E5		S-280ME2E5		S-224ME2E5		S-280ME2E5					
	Cooling	Heating	Cooling	Heating	Cooling	Heating	Cooling	Heating				
Capacity	kW	22.4	21.2	28.0	26.5	22.4	25.0	28.0	31.5			
Input power	W	290.00	290.00	350.00	350.00	440.00	440.00	715.00	715.00			
Current	A	1.85	1.85	2.20	2.20	2.45	2.45	3.95	3.95			
Air flow	Hi / Med / Lo	m ³ /sec		0.47 / — / —		0.58 / — / —		0.93 / 0.85 / 0.73		1.20 / 1.05 / 0.88		
External static pressure	Pa	200		200		140 (60-270) ¹⁾		140 (72-270) ¹⁾				
Sound pressure ²⁾	Hi / Med / Lo	dB(A)		43 / — / —		44 / — / —		45 / 43 / 41		49 / 47 / 43		
Sound power	Hi / Med / Lo	dB(A)		75 / — / —		76 / — / —		77 / 75 / 73		81 / 79 / 75		
Dimension	H x W x D	mm		479 x 1453 x 1205		479 x 1453 x 1205		479 x 1453 x 1205		479 x 1453 x 1205		
Net weight	kg	102		106		102		106				
Piping diameter	Liquid pipe	Inch (mm)	3/8 (9.52)		3/8 (9.52)		3/8 (9.52)		3/8 (9.52)			
	Gas pipe	Inch (mm)	3/4 (19.05)		7/8 (22.22)		3/4 (19.05)		7/8 (22.22)			
RRP	£	5.072		5.449		5.072		5.449				

Rating Conditions for 100 % Fresh air duct function: Cooling Outdoor 33 °C DB / 28 °C WB. Heating Outdoor 0 °C DB / -2.9 °C WB.

1) Available to select the setting by initial setup. 2) Values with 140 Pa setting. * No filter included. ** No compatible with 3-Pipe ECO G GF3.

Accessories	RRP £
CZ-RTC6 CONEX wired remote controller (non-wireless)	144
CZ-RTC6BL CONEX wired remote controller with Bluetooth®	172
CZ-RTC5B Wired remote controller with Econavi function	144
CZ-RWS3 + CZ-RWRC3 Infrared remote controller and receiver	276
PAW-RE2C4-MOD-WH Modbus RS-485 touch room controller with I/O, white	444

Accessories	RRP £
PAW-RE2C4-MOD-BK Modbus RS-485 touch room controller with I/O, black	444
PAW-RE2D4-WH Touch display control with 2 digital inputs, white	271
PAW-RE2D4-BK Touch display control with 2 digital inputs, black	271
CZ-CENSC1 Econavi energy savings sensor	151

Technical focus

- No need of rap valve
- 100 % fresh air duct function*
- DC fan motor for more savings
- Complete flexibility for ductwork design

- Can be located into a weatherproof housing for external siting
- Air OFF sensor avoids cold air dumping
- Configurable air temperature control

* Rap valves required, see 100 % fresh air duct function below.

System example

An inspection port (450 x 450 mm or more) is required at the lower side of the indoor unit body (field supply).

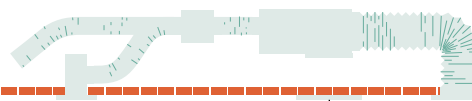

100 % fresh air duct function

The E2 duct with 100 % fresh air duct function have exceptional discharge temperature.

	Discharge Range		
	Min	Max	Default
Cooling	15 °C	24 °C	18 °C
Heating	17 °C	45 °C	40 °C

Plenums

Air outlet plenum (suitable for rigid + flexible duct)		
	Number of exits with diameters	Model
S-224ME2E5 / S-280ME2E5	1 x 500 mm	CZ-TREMIESPW706

Kit for 100 % fresh air function

Kit for 100 % fresh air function for 2 way systems	
2x CZ-P160RVK2	Rap valve kit
2x CZ-CAPE2	3 way control PCB
CZ-P680BK2BM	Distribution joint kit
	1x remote controller

Kit for 100 % fresh air function for 3 way systems	
2x CZ-P160HR3	3 way valve Kit
2x CZ-CAPE2	3 way control PCB
CZ-P680BH2BM	Distribution joint kit
	1x remote controller



ECONAVI and INTERNET CONTROL: Optional.

Rating Conditions: Cooling Indoor 27 °C DB / 19 °C WB. Cooling Outdoor 35 °C DB / 24 °C WB. Heating Indoor 20 °C DB. Heating Outdoor 7 °C DB / 6 °C WB. (DB: Dry Bulb; WB: Wet Bulb). Specifications subject to change without notice. For detailed information about ErP / Energy Labelling, please visit our websites www.panasonic.co.uk/aircon or www.ptc.panasonic.eu.

Heat recovery with DX coil - R410A

Motorised heat recovery by-pass device automatically controlled by unit control to use fresh air free-cooling when convenient.



COMPATIBLE WITH ALL PANASONIC CONNECTIVITY SOLUTIONS. FOR DETAILED INFORMATION GO TO THE CONTROL SYSTEMS SECTION

Model			PAW-500ZDX3N		PAW-800ZDX3N		PAW-01KZDX3N	
Power supply	Voltage	V	230		230		230	
	Phase		Single phase		Single phase		Single phase	
	Frequency	Hz	50		50		50	
Air flow		m ³ /sec	0.14		0.22		0.28	
External static pressure ¹⁾		Pa	90		120		115	
Maximum current	Total full load	A	0.6		1.4		2.1	
Input power		W	150		320		390	
Sound pressure ²⁾		dB(A)	39		42		43	
Piping diameter	Liquid pipe	Inch (mm)	1/4(6.35)		1/4(6.35)		1/4(6.35)	
	Gas pipe	Inch (mm)	1/2(12.70)		1/2(12.70)		1/2(12.70)	
Heat recovery			Cooling	Heating	Cooling	Heating	Cooling	Heating
Temperature efficiency	%		76	76	76	76	76	76
Enthalpy efficiency	%		63	67	63	65	60	62
Saved power summer mode or winter mode*	kW		1.70	4.30(4.80)	2.50	6.50(7.30)	3.20	8.20(9.00)
DX coil								
Total / Sensible capacity	kW		3.00/2.10	2.50/2.70	5.10/3.50	4.40/4.80	5.80/4.10	5.20/6.70
OFF temperature	°C		15.9	28.0(27.3)	15.5	29.6(29.0)	16.2	28.5(27.8)
OFF relative humidity	%		90	16(15)	90	14(13)	89	15(14)
RRP	£		3.873		4.615		4.954	

Nominal summer conditions: Outside air: 32 °C DB, RH 50 %. Ambient air: 26 °C DB, RH 50 %. Nominal winter conditions: Outside air: -5 °C DB, RH 80 %. Ambient air: 20 °C DB, RH 50 %. Cooling mode air inlet condition: 28.5 °C DB, RH 50 %; evaporating temperature 7 °C. Heating mode air inlet condition: 13 °C DB, RH 40 % (11 °C DB, RH 45 %); condensating temperature 40 °C. DB: Dry Bulb; RH: Relative Humidity. 1) Referred to the nominal air flow after filter and plate heat exchanger. 2) Sound pressure level calculated at 1 m far from: ducted supply exhaust air ducted return - first air intake / service side, at normal condition. * Tentative data.

Accessories	RRP £
CZ-RTC6 CONEX wired remote controller (non-wireless)	144
CZ-RTC6BL CONEX wired remote controller with Bluetooth®	172
CZ-RTC5B Wired remote controller with Econavi function	144
PAW-RE2C4-MOD-WH Modbus RS-485 touch room controller with I/O, white	444

Accessories	RRP £
PAW-RE2C4-MOD-BK Modbus RS-485 touch room controller with I/O, black	444
PAW-RE2D4-WH Touch display control with 2 digital inputs, white	271
PAW-RE2D4-BK Touch display control with 2 digital inputs, black	271

Technical focus

- Galvanized steel self-supporting panels, internally and externally insulated
- High efficiency enthalpic heat recover, static cross flow type, made by membrane with high moisture permeability, good air tightness, excellent tear, and aging resistance, structure consisting of flat and corrugated plates. Total heat exchange with temperature efficiency up to 76 % and enthalpy efficiency up to 67 %, also at high level during summer season
- ISO16890 ePm2.5 95 % (F9 EN 779) efficiency class filter with synthetic cleanable media and COARSE 50 % (G3 EN 779) pre-filter ON fresh air, COARSE 50 % filter on return air intake
- Removable side panel to access filters and heat recovery in the event of scheduled maintenance
- Low consumption, high efficiency and low noise direct driven fans
- Supply section complete with DX coil (R410A) fitted with solenoid control valve, freon filter, contact temperature sensors on liquid and gas line, NTC sensors upstream and downstream of air flow

- Built-in electric box equipped with PCB to control internal fan speed and to interconnect outdoor / indoor units
- Duct connection by circular plastic collars

Balanced ventilation

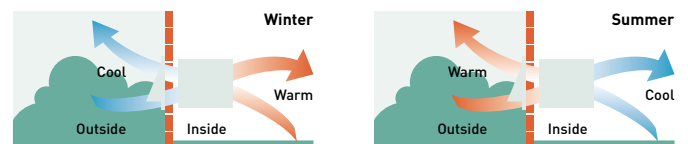

Interconnection to outdoor / indoor units

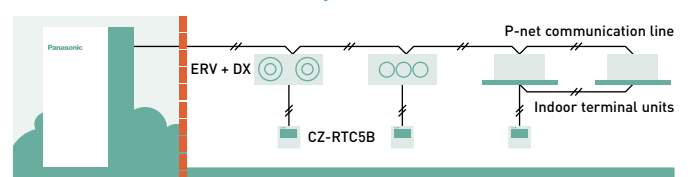

INTERNET CONTROL: Optional.



T2 Type ceiling · R410A

The T2 Type ceiling mounted units feature a DC fan motor for increased efficiency and reduced operating sound levels.

All the units are the same height and depth for a uniform appearance in mixed installations, and feature a fresh air knockout for improved air quality.

COMPATIBLE WITH ALL PANASONIC CONNECTIVITY SOLUTIONS. FOR DETAILED INFORMATION GO TO THE CONTROL SYSTEMS SECTION

Model		S-36MT2E5A	S-45MT2E5A	S-56MT2E5A	S-73MT2E5A	S-106MT2E5A	S-140MT2E5A	
Cooling capacity	kW	3.6	4.5	5.6	7.3	10.6	14.0	
Input power	W	35.00	40.00	40.00	55.00	80.00	100.00	
Current	A	0.36	0.38	0.38	0.44	0.67	0.79	
Heating capacity	kW	4.2	5.0	6.3	8.0	11.4	16.0	
Input power	W	35.00	40.00	40.00	55.00	80.00	100.00	
Current	A	0.36	0.38	0.38	0.44	0.67	0.79	
Fan type		Sirocco fan	Sirocco fan	Sirocco fan	Sirocco fan	Sirocco fan	Sirocco fan	
Air flow	Hi / Med / Lo	m³/sec	0.23/0.20/0.18	0.25/0.21/0.18	0.25/0.21/0.18	0.35/0.30/0.26	0.50/0.42/0.38	0.53/0.47/0.40
Sound pressure	Hi / Med / Lo	dB(A)	36/32/30	37/33/30	37/33/30	39/35/33	42/37/36	46/40/37
Sound power	Hi / Med / Lo	dB(A)	54/50/48	55/51/48	55/51/48	57/53/51	60/55/54	62/58/55
Dimension	HxWxD	mm	235x960x690	235x960x690	235x960x690	235x1275x690	235x1590x690	235x1590x690
Net weight		kg	27	27	27	33	40	40
Piping diameter	Liquid pipe	Inch (mm)	1/4(6.35)	1/4(6.35)	1/4(6.35)	3/8(9.52)	3/8(9.52)	3/8(9.52)
	Gas pipe	Inch (mm)	1/2(12.70)	1/2(12.70)	1/2(12.70)	5/8(15.88)	5/8(15.88)	5/8(15.88)
RRP	£	1.318	1.386	1.453	1.516	1.847	2.111	

Accessories		RRP £
CZ-RTC6	CONEX wired remote controller (non-wireless)	144
CZ-RTC6BL	CONEX wired remote controller with Bluetooth®	172
CZ-RTC5B	Wired remote controller with Econavi function	144
CZ-RWS3 + CZ-RWRT3	Infrared remote controller and receiver	276
PAW-RE2C4-MOD-WH	Modbus RS-485 touch room controller with I/O, white	444

Accessories		RRP £
PAW-RE2C4-MOD-BK	Modbus RS-485 touch room controller with I/O, black	444
PAW-RE2D4-WH	Touch display control with 2 digital inputs, white	271
PAW-RE2D4-BK	Touch display control with 2 digital inputs, black	271
CZ-CENSC1	Econavi energy savings sensor	151

Technical focus

- Low sound levels
- All units just 235 mm high
- Large and wide air distribution
- Easy to install and maintain
- Fresh air knockout

Air distribution is altered depending on the operational mode

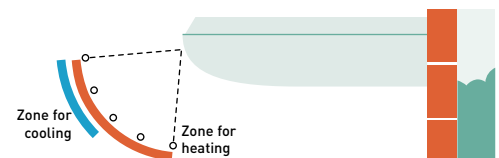

Further comfort improvement with air flow distribution

Horizontal air flow reaches maximum 9.5 m. This is ideal for wide rooms.

The wide air discharge opening expands the air flow to the left and right. The unpleasant feeling caused when the air flow directly hits the human body is prevented by the "Draft prevention position", which changes the swing width, increasing the degree of comfort.

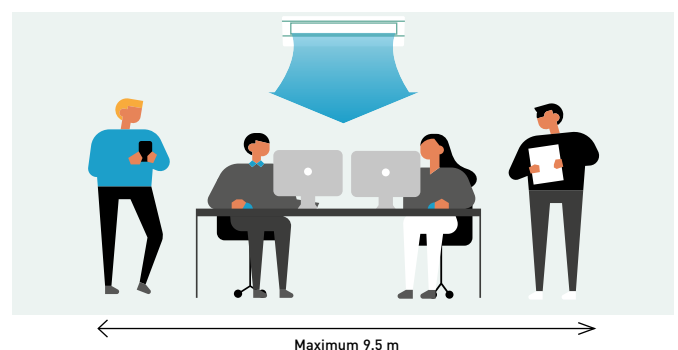

ECONAVI and INTERNET CONTROL: Optional.

Rating Conditions: Cooling Indoor 27 °C DB / 19 °C WB. Cooling Outdoor 35 °C DB / 24 °C WB. Heating Indoor 20 °C DB. Heating Outdoor 7 °C DB / 6 °C WB. [DB: Dry Bulb; WB: Wet Bulb]. Specifications subject to change without notice. For detailed information about ErP / Energy Labelling, please visit our websites www.panasonic.co.uk/aircon or www.ptc.panasonic.eu.

K2 Type wall-mounted · R32 / R410A

The wall-mounted unit has a stylish smooth panel that looks good and is easy to clean.

The unit is also smaller, lighter and substantially quieter than previous models making it ideal for small offices and other commercial applications.

COMPATIBLE WITH ALL PANASONIC CONNECTIVITY SOLUTIONS. FOR DETAILED INFORMATION GO TO THE CONTROL SYSTEMS SECTION



Model		S-15MK2E5B	S-22MK2E5B	S-28MK2E5B	S-36MK2E5B	S-45MK2E5B	S-56MK2E5B	S-73MK2E5B	S-106MK2E5B	
Cooling capacity	kW	1.5	2.2	2.8	3.6	4.5	5.6	7.3	10.6	
Input power	W	25.00	25.00	25.00	30.00	30.00	35.00	55.00	80.00	
Current	A	0.20	0.21	0.23	0.25	0.32	0.35	0.51	0.70	
Heating capacity	kW	1.7	2.5	3.2	4.2	5.0	6.3	8.0	11.4	
Input power	W	25.00	25.00	25.00	30.00	30.00	35.00	55.00	80.00	
Current	A	0.20	0.21	0.23	0.25	0.32	0.35	0.51	0.70	
Fan type		Cross flow	Cross flow	Cross flow	Cross flow	Cross flow	Cross flow	Cross flow	Cross flow	
Air flow	Cool (Hi / Med / Lo)	m ³ /sec	0.13/0.12/0.11	0.15/0.13/0.11	0.16/0.14/0.11	0.18/0.15/0.11	0.24/0.21/0.17	0.27/0.23/0.20	0.33/0.28/0.23	0.36/0.31/0.25
	Heat (Hi / Med / Lo)	m ³ /sec	0.15/0.13/0.11	0.15/0.14/0.11	0.16/0.14/0.11	0.19/0.16/0.11	0.24/0.21/0.17	0.27/0.23/0.20	0.33/0.28/0.23	0.36/0.31/0.25
Sound pressure	Hi / Med / Lo	dB(A)	34/32/29	36/33/29	37/34/29	40/36/29	38/35/33	40/37/35	47/44/40	49/46/42
Sound power	Hi / Med / Lo	dB(A)	49/47/44	51/48/44	52/49/44	55/51/44	53/50/48	55/52/50	62/59/55	64/61/57
Dimension	H x W x D	mm	290 x 870 x 214	290 x 870 x 214	290 x 870 x 214	290 x 870 x 214	302 x 1120 x 236	302 x 1120 x 236	302 x 1120 x 236	302 x 1120 x 236
Net weight		kg	9	9	9	9	13	13	14	14
Piping diameter	Liquid pipe	Inch (mm)	1/4 (6.35)	1/4 (6.35)	1/4 (6.35)	1/4 (6.35)	1/4 (6.35)	1/4 (6.35)	3/8 (9.52) ¹⁾	3/8 (9.52)
	Gas pipe	Inch (mm)	1/2 (12.70)	1/2 (12.70)	1/2 (12.70)	1/2 (12.70)	1/2 (12.70)	1/2 (12.70)	5/8 (15.88) ¹⁾	5/8 (15.88)
RRP	£	665	688	687	722	827	879	1,042	1,069	

1) When the piping diameter is (liquid) Ø1/4 (6.35) - (gas) Ø1/2 (12.70), connect the liquid socket tube (Ø6.35 - Ø9.52) to the liquid tubing side indoor unit and connect the gas socket tube (Ø12.70 - Ø15.88) to the gas tubing side indoor unit.

Accessories		RRP £
CZ-RTC6	CONEX wired remote controller (non-wireless)	144
CZ-RTC6BL	CONEX wired remote controller with Bluetooth®	172
CZ-RTC5B	Wired remote controller with Econavi function	144
CZ-RWS3	Infrared remote controller	108
PAW-RE2C4-MOD-WH	Modbus RS-485 touch room controller with I/O, white	444
PAW-RE2C4-MOD-BK	Modbus RS-485 touch room controller with I/O, black	444

Accessories		RRP £
PAW-RE2D4-WH	Touch display control with 2 digital inputs, white	271
PAW-RE2D4-BK	Touch display control with 2 digital inputs, black	271
CZ-CENSC1	Econavi energy savings sensor	151
CZ-P56SVK2	External valve for model sizes 15 to 56	180
CZ-P160SVK2	External valve for model sizes 73 to 106	227
CZ-CGLSC1	Panasonic R32 refrigerant leak detector	160

Technical focus

- Compact lightweight units for easy installation
- Quiet operation
- Smooth and durable design
- Piping outlet in six directions
- Air distribution is automatically altered depending on the operational mode

Air distribution is automatically altered depending on the operational mode of the unit

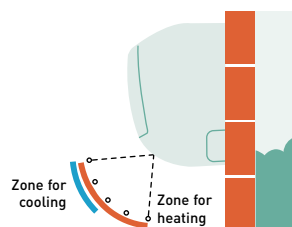

Quiet operation

These units are among the quietest in the industry, making them ideal for hotels and hospitals.

Lighter and smaller units

Compact and lightweight units make for easy installation. When the unit is turned OFF, the flap closes completely to prevent entry of dust into the unit and to keep the equipment clean.



Piping outlet in six directions

Piping outlet is possible in six directions of; right, right rear, right bottom, left, left rear and left bottom, making installation flexible.



External valve (optional)

CZ-P56SVK2 (model sizes 15 to 56).
CZ-P160SVK2 (model sizes 73¹⁾ to 106).

1) When the piping diameter is liquid 1/4 (6.35) and gas 1/2 (12.70), use CZ-P56SVK2



ECONAVI and INTERNET CONTROL: Optional.



nanoe™ X as a standard.



G1 Type floor console - R410A

The stylish and compact unit profile, also used for residential market range, is easy to integrate into any design of building.

Compact and versatile, this system is capable of being installed in an area with limited space. It is a perfect solution for retrofit, replacing existing radiator panels.

COMPATIBLE WITH ALL PANASONIC CONNECTIVITY SOLUTIONS. FOR DETAILED INFORMATION GO TO THE CONTROL SYSTEMS SECTION

Model		S-22MG1E5N	S-28MG1E5N	S-36MG1E5N	S-45MG1E5N	S-56MG1E5N	
Cooling capacity	kW	2.2	2.8	3.6	4.5	5.6	
Input power	W	20.00	20.00	22.00	28.00	31.00	
Current	A	0.20	0.20	0.23	0.25	0.28	
Heating capacity	kW	2.5	3.2	4.2	5.0	6.3	
Input power	W	21.00	21.00	23.00	29.00	32.00	
Current	A	0.20	0.20	0.24	0.26	0.28	
Fan type		Cross flow	Cross flow	Cross flow	Cross flow	Cross flow	
nanoe X Generator		Mark 1	Mark 1	Mark 1	Mark 1	Mark 1	
Air flow	Cool (Hi / Med / Lo)	m ³ /sec	0.15/0.13/0.10	0.15/0.13/0.10	0.16/0.14/0.10	0.18/0.15/0.11	0.20/0.16/0.11
	Heat (Hi / Med / Lo)	m ³ /sec	0.16/0.13/0.11	0.16/0.13/0.11	0.17/0.15/0.11	0.18/0.16/0.12	0.21/0.17/0.12
Sound pressure	Hi / Med / Lo	dB(A)	38/34/29	38/34/29	39/35/29	42/37/30	44/38/30
Dimension	H x W x D	mm	600 x 750 x 207	600 x 750 x 207	600 x 750 x 207	600 x 750 x 207	600 x 750 x 207
Net weight		kg	14	14	14	14	14
Piping diameter	Liquid pipe	Inch (mm)	1/4(6.35)	1/4(6.35)	1/4(6.35)	1/4(6.35)	1/4(6.35)
	Gas pipe	Inch (mm)	1/2(12.70)	1/2(12.70)	1/2(12.70)	1/2(12.70)	1/2(12.70)
RRP	£	1.344	1.413	1.487	1.570	1.687	

Accessories		RRP £
CZ-RTC6	CONEX wired remote controller (non-wireless)	144
CZ-RTC6BL	CONEX wired remote controller with Bluetooth®	172
CZ-RTC5B	Wired remote controller with Econavi function	144
CZ-RWS3*	Infrared remote controller	108
PAW-RE2C4-MOD-WH	Modbus RS-485 touch room controller with I/O, white	444

* Infrared receiver is integrated with the unit as standard.

Accessories		RRP £
PAW-RE2C4-MOD-BK	Modbus RS-485 touch room controller with I/O, black	444
PAW-RE2D4-WH	Touch display control with 2 digital inputs, white	271
PAW-RE2D4-BK	Touch display control with 2 digital inputs, black	271
CZ-CENSC1	Econavi energy savings sensor	151

1 nanoe™ X: Bringing nature's balance indoors

Panasonic's nanoe™ X technology brings nature's detergent – hydroxyl radicals – indoors to help improve protection 24/7 against several types of pollutants can be inhibited such as certain types of bacteria, viruses, mould, allergens, pollen or hazardous substances.

2 Stylish and simple

- Clean and modern European design with slim depth
- Modern matt white color panel
- Washable air filter

The stylish and compact unit profile, also used for residential market range, is easy to integrate into any design of building.



Dimension:
W x H x D = 750 x 600 x 207 mm

Weight:
14kg

3 Flexible easy installation

- Four different mounting styles possible:
- Exposed (floor or wall)
 - Semi-recessed
 - Recessed

Flexible installation with 4 different options.

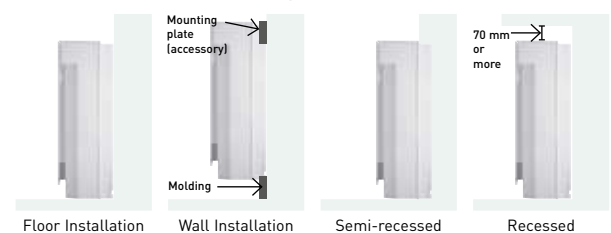

4 Functions for comfort

- Double Air Flow direction to maximize comfort
- Self-cleaning function
- Compatible with Commercial Wi-Fi Adaptor for cloud control

Self-cleaning function.

- Self cleaning function can be pre-scheduled with remote controller, up to a maximum of 90 minutes following cooling / dry operation
- Air flow will not blow directly at occupants during self-cleaning



ECONAVI and INTERNET CONTROL: Optional.

Rating Conditions: Cooling Indoor 27 °C DB / 19 °C WB. Cooling Outdoor 35 °C DB / 24 °C WB. Heating Indoor 20 °C DB. Heating Outdoor 7 °C DB / 6 °C WB. [DB: Dry Bulb; WB: Wet Bulb]. Specifications subject to change without notice. For detailed information about ErP / Energy Labelling, please visit our websites www.panasonic.co.uk/aircon or www.ptc.panasonic.eu.



P1 Type floor-standing · R410A

The compact floor-standing P1 units are the ideal solution for providing perimeter air conditioning.

R1 Type concealed floor-standing · R410A

At just 229 mm deep, the R1 unit can be easily concealed in perimeter areas to provide powerful and effective air conditioning.

COMPATIBLE WITH ALL PANASONIC CONNECTIVITY SOLUTIONS. FOR DETAILED INFORMATION GO TO THE CONTROL SYSTEMS SECTION

P1 Model		S-22MP1E5	S-28MP1E5	S-36MP1E5	S-45MP1E5	S-56MP1E5	S-71MP1E5	
R1 Model		S-22MR1E5	S-28MR1E5	S-36MR1E5	S-45MR1E5	S-56MR1E5	S-71MR1E5	
Cooling capacity	kW	2.2	2.8	3.6	4.5	5.6	7.1	
Input power	W	56.00	56.00	85.00	126.00	126.00	160.00	
Current	A	0.25	0.25	0.38	0.56	0.56	0.72	
Heating capacity	kW	2.5	3.2	4.2	5.0	6.3	8.0	
Input power	W	40.00	40.00	70.00	91.00	91.00	120.00	
Current	A	0.18	0.18	0.31	0.41	0.41	0.54	
Fan type		Sirocco fan	Sirocco fan	Sirocco fan	Sirocco fan	Sirocco fan	Sirocco fan	
Air flow	Hi / Med / Lo	m ³ /sec	0.12/0.10/0.08	0.12/0.10/0.08	0.15/0.12/0.10	0.20/0.15/0.13	0.25/0.22/0.18	0.28/0.23/0.20
External static pressure	Pa	15	15	15	15	15	15	
Sound pressure	Hi / Med / Lo	dB(A)	33/30/28	33/30/28	39/35/29	38/35/31	39/36/31	41/38/35
P1 Dimensions	H x W x D	mm	615 x 1065 x 230	615 x 1065 x 230	615 x 1065 x 230	615 x 1380 x 230	615 x 1380 x 230	615 x 1380 x 230
R1 Dimensions	H x W x D	mm	616 x 904 x 229	616 x 904 x 229	616 x 904 x 229	616 x 1219 x 229	616 x 1219 x 229	616 x 1219 x 229
P1 Net weight	kg	29	29	29	39	39	39	
R1 Net weight	kg	21	21	21	28	28	28	
Piping diameter	Liquid pipe	Inch (mm)	1/4 (6.35)	1/4 (6.35)	1/4 (6.35)	1/4 (6.35)	1/4 (6.35)	3/8 (9.52)
	Gas pipe	Inch (mm)	1/2 (12.70)	1/2 (12.70)	1/2 (12.70)	1/2 (12.70)	1/2 (12.70)	5/8 (15.88)
P1 Model RRP	£	1.342	1.345	1.378	1.567	1.584	1.670	
R1 Model RRP	£	1.162	1.230	1.303	1.376	1.479	1.506	

Accessories	RRP £
CZ-RTC6 CONEX wired remote controller (non-wireless)	144
CZ-RTC6BL CONEX wired remote controller with Bluetooth®	172
CZ-RTC5B Wired remote controller with Econavi function	144
CZ-RWS3 + CZ-RWRC3 Infrared remote controller and receiver	276

Accessories	RRP £
PAW-RE2C4-MOD-WH Modbus RS-485 touch room controller with I/O, white	444
PAW-RE2C4-MOD-BK Modbus RS-485 touch room controller with I/O, black	444
PAW-RE2D4-WH Touch display control with 2 digital inputs, white	271
PAW-RE2D4-BK Touch display control with 2 digital inputs, black	271

P1 Technical focus

- Pipes can be connected to either side of the unit from the bottom or rear
- Easy to install
- Front panel opens fully for easy maintenance
- Removable air discharge grille gives flexible airflow
- Room for condensate pump

R1 Technical focus

- Chassis unit for discreet installation
- Complete with removable filters
- Pipes can be connected to either side of the unit from the bottom or rear
- Easy to install

Effective perimeter handling

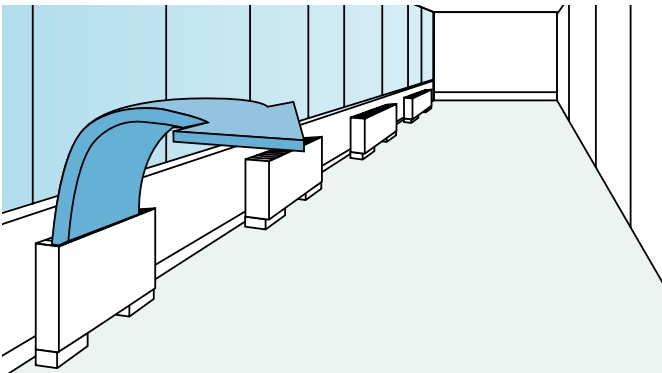

Perimeter air conditioning with high interior quality

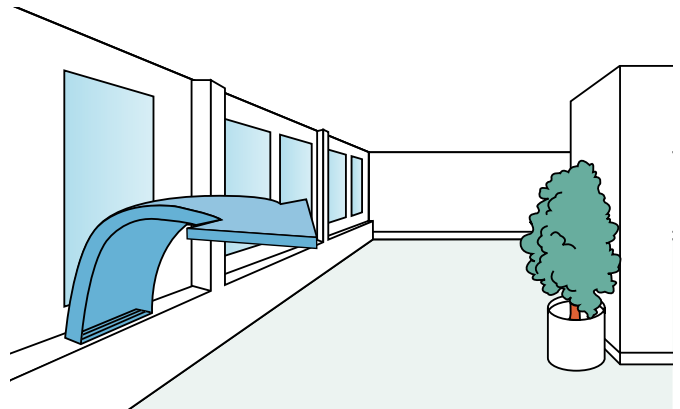

INTERNET CONTROL: Optional.



Hydrokit for ECOi, water at 45 °C · R410A

Connect the Hydrokit to your VRF system, together with other indoor units.

Total system performs high energy efficiency through heat recovering operation, and it gives an advantage for sustainability related assessment methods, such as BREEAM in UK.

COMPATIBLE WITH ALL PANASONIC CONNECTIVITY SOLUTIONS. FOR DETAILED INFORMATION GO TO THE CONTROL SYSTEMS SECTION

Model			S-80MW1E5	S-125MW1E5
Power supply	Voltage	V	230	230
	Phase		Single phase	Single phase
	Frequency	Hz	50	50
Cooling capacity		kW	8.0	12.5
Heating capacity		kW	9.0	14.0
Maximum temperature		°C	-45 / -65 ¹⁾	-45 / -65 ¹⁾
Dimension	H x W x D	mm	892 x 502 x 353	892 x 502 x 353
Water pipe connector		Inch	R 1 ¼	R 1 ¼
Water pump (built-in)			DC motor (A class)	DC motor (A class)
Water flow rate	Cool	L/min	22.90	35.80
	Heat	L/min	25.80	40.10
Piping diameter	Liquid pipe	Inch (mm)	3/8 (9.52)	3/8 (9.52)
	Gas pipe	Inch (mm)	5/8 (15.88)	5/8 (15.88)
	Drain pipe	mm	15 ~ 17 (inner size)	15 ~ 17 (inner size)
Operating range	Cool	Ambient	°C	+10 ~ +43
		Water	°C	+5 ~ +20
	Heat	Ambient	°C	-20 ~ +43
		Water	°C	+25 ~ +45
Connectable system	3-Pipe (heat recovery type) VRF System (system capable up to 48 HP)			
Maximum Indoor ratio (connectable hydrokit module capacity ratio)			Total indoor unit + Hydrokit capacity: up to 130 % (** ~ **% vs total outdoor unit capacity)	
RRP	£		2,982	3,578

1) Maximum 45 °C by refrigerant circuit (heat pump cycle), over 45 °C is provided by electric heater operation.

Accessories		RRP £
CZ-RTC5B	Wired remote controller with Econavi function	144
PAW-RE2C4-MOD-WH	Modbus RS-485 touch room controller with I/O, white	444
PAW-RE2C4-MOD-BK	Modbus RS-485 touch room controller with I/O, black	444

Accessories		RRP £
PAW-RE2D4-WH	Touch display control with 2 digital inputs, white	271
PAW-RE2D4-BK	Touch display control with 2 digital inputs, black	271

Basic principle and advantage.

Hydrokit module provides hot water by using waste heat that is recovered from standard air-conditioning indoor unit in cooling mode.

Technical focus

- Only with 3-Pipe ECOi EX MF3 Series outdoor units
- Remote controller CZ-RTC5B common use with DX coil indoor units ECOi and PACi

Hydrokit control function / CZ-RTC5B

- CZ-RTC5B can be used for hydrokit and also normal indoor unit. CZ-RTC5B checks the type of connected unit and switches between hydrokit and air conditioner display automatically

- Hydrokit mode (tank or air conditioning mode) is set during initial startup

Overview: hydromodule in VRF system

- Multiple hydromodule connection in same circuit is available
- The mode of each module can be individually set from either hot water or space heating (once set the units cannot operate in another mode, resetting will be required)
- 3-Pipe control solenoid valve kit is necessary for each indoor unit and hydromodule

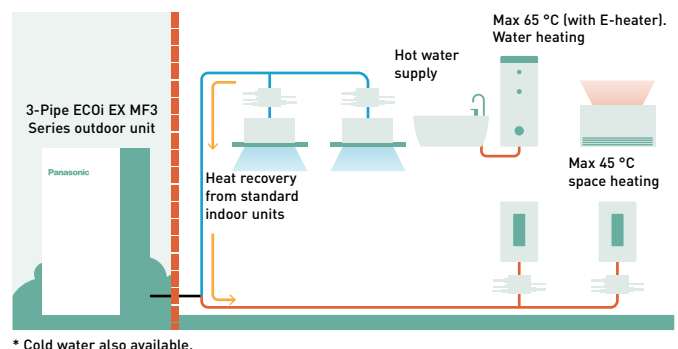



PRO-HT TANK

PRO-HT Tank DHW

Enjoy an efficient DHW and heating and cooling tank. Panasonic commercial PRO-HT Tank solutions meet all needs of your hot water applications providing 65 °C maximum water temperature.

High temperature hot water is efficiently produced without any boosters.

Can be combined with ECOi 3-Pipe to adapt various projects from high-end residential to offices and hotels.

PRO-HT Tank			PAW-VP750LDHW-1	PAW-VP1000LDHW-1
Outdoor unit			U-16MF3E8	U-16MF3E8
Power supply	Voltage	V	400	400
	Phase		Three phase	Three phase
	Frequency	Hz	50	50
Volume (net)		L	726	933
Dimension	H x Diameter	mm	1855 x 990	2210 x 990
Net weight / with water		kg	179 / 929	191 / 1121
Connections to the water supply network			1 1/4"	1 1/4"
Nominal electrical power		kW	5.12	6.14
Reference tapping cycle			2XL	2XL
Energy consumption by chosen cycle [A +7 °C, W 10-55 °C]		kWh	4.14	5.10
Energy consumption by chosen cycle [A +15 °C, W 10-55 °C]		kWh	3.50	4.61
COP DHW [A +7 °C, W 10-55 °C] EN 16147 ¹⁾			5.29	4.81
COP DHW [A +15 °C, W 10-55 °C] EN 16147 ²⁾			7.01	5.32
Standby input power according to EN16147		W/h	77	80
Sound pressure at 1m		dB(A)	52	52
Average insulation thickness		mm	100	100
Heat exchanger connection	Inlet	Inch (mm)	1/2(12.70)	1/2(12.70)
	Outlet	Inch (mm)	3/4(19.05)	3/4(19.05)
Maximum power consumption	Without heater	kWh	20.4	20.4
	With heater	kWh	26.4	26.4
Number of electrical heaters x power		W	1 x 6000	1 x 6000
Electric protection		A	16	16
Moisture protection			IP24	IP24
Refrigerant (R410A) / CO ₂ , Eq.		kg / T	8.3 / 17.1	8.3 / 17.1
Maximum water temperature	Heat pump	°C	65	65
	Electrical heater	°C	85	85
Operating range - outdoor ambient	Heat Min ~ Max	°C	-20 ~ +35	-20 ~ +35
PRO-HT Tank RRP		£	13.185	13.971
Outdoor unit RRP		£	13.243	13.243

1) Heating of sanitary water up to 55 °C with inlet air temperature at 7 °C, humidity at 89 % and inlet water temperature at 10 °C. According to EN16147. 2) Heating of sanitary water up to 55 °C with inlet air temperature at 15 °C, humidity at 74 % and inlet water temperature at 10 °C. According to EN16147. This product is designed to meet the European Drinking Directive 98/83/EC amended by 2015/1787/EU. The lifespan of the product is not guaranteed in the case of the use of groundwater, such as spring water or well water, the use of tap water when salt or other impurities are contained, nor in areas of acidic water quality. Maintenance and warranty costs related to these cases are the customer's responsibility. * When connected as pressurised, safety valve is mandatory.

Accessories	RRP £
PAW-VP-RTC5B-VRF Tank Controller for ECOi system	1.385
PAW-VP-VALV-160 Expansion valve kit 16 kW	40

Accessories	RRP £
PAW-VP-VALV-280 Expansion valve kit 28 kW	103

Solution example DHW tank 1000 L + ECOi 3-Pipe

- Ideal offer for hotel projects
- DHW production under spontaneous heating and cooling
- Hot water up to 65 °C is efficiently produced by heat recovery
- A7 COP 6.7 considering heat recovery

Technical focus

- Water volume 750 L and 1000 L
- Maximum hot water production 65 °C without boosters
- Heating coil 52 m (750 L) and 63 m (1000 L)
- Tank material 3 mm
- ABS external case

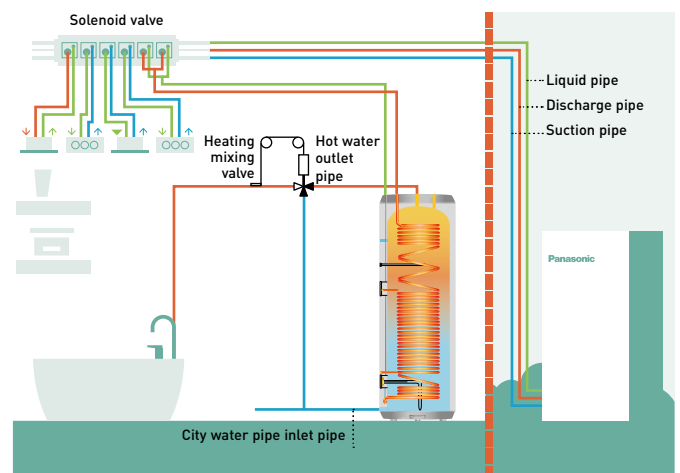

BMS interface with P-Link

BMS interface with Panasonic communication bus helps you to get significant savings.

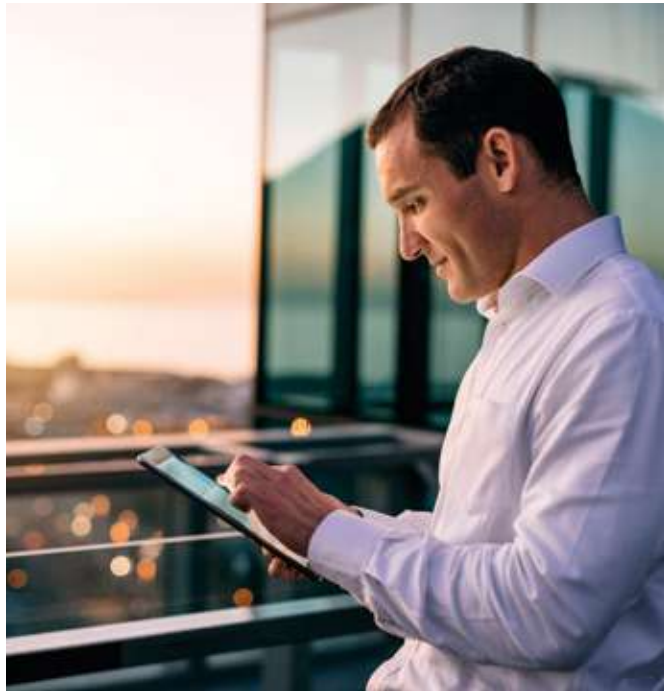

1 Direct connection to P-Communication bus

- No need for additional gateway (CZ-CFUNC2)
- Significant 50 % cost saving for BMS interface*
- Avoid mistakes and reduce configuration time.

* In the case of PAW-AC2-BAC-16P by Panasonic calculation.

2 Easy configuration

- Single configuration tool for all models (Intesis MAPS)
- Firmware updates with new improvements and features
- Scan: Automatic identification of the units present in the VRF system
- Front cover LED indicators provide easy to check communication status.

3 Upgraded specifications

- Outdoor unit's signal available for the integration
- BACnet: Version 14 and BTL Certified
- Datalogging through external USB port (for service)

Direct connection to P-Communication bus

The interface can provide faster, cheaper, easier solution in your projects!

Old interface.

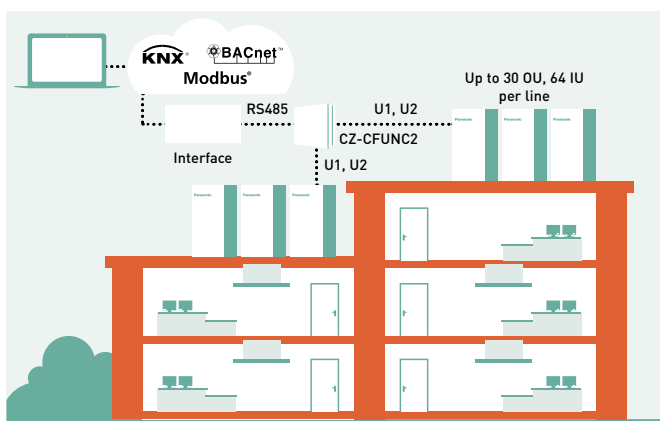

Maximum 128 indoor units can be connected. Panasonic Gateway, CZ-CFUNC2 is required.

Interface with P-communication bus.

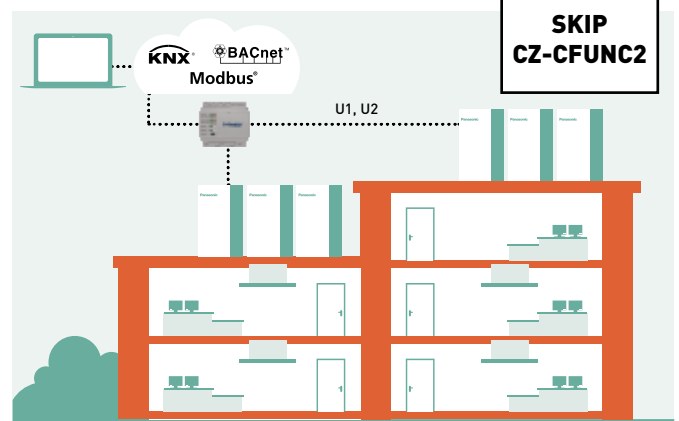

U1U2 link is connected directly to IntesisBox. Support from 16 to 128 per each box.

Home automation compatibility for Smart Home systems for PAW-AC2-MBS

Drivers available for:

- AMX
- Control4
- eedomus
- Elan
- Fibaro
- iRidium
- Eedom
- RTI
- Savant

Creston, Kuju and Vera available soon.

Model for BACnet	Maximum number of indoor units connected
PAW-AC2-BAC-16P	16 indoor units
PAW-AC2-BAC-64P	64 indoor units
PAW-AC2-BAC-128P	128 indoor units
Model for Modbus	Maximum number of indoor units connected
PAW-AC2-MBS-16P	16 indoor units
PAW-AC2-MBS-64P	64 indoor units
PAW-AC2-MBS-128P	128 indoor units
Model for KNX	Maximum number of indoor units connected
PAW-AC2-KNX-16P	16 indoor units
PAW-AC2-KNX-64P	64 indoor units

Fan coils highlighted features

MORE FAN COIL OPTIONS
IN CHILLERS SECTION

Available in a wide range of designs, the fan coils are perfectly adapted to fit within almost any location.



1 Innovation for optimum comfort

Range of fan coil for heating and cooling with capacities from 0.2 to 9.6 kW in cooling and from 0.2 to 13.6 kW in heating. Bring full year comfort with water based systems.

2 Energy efficient and low noise fan

Dynamically balanced and specially designed fans, reinforced acoustic insulation and optimised fan speed staging for lower noise levels. Improved efficiency with optional EC fan motor.

3 Quality and efficient coil

Constructed from staggered copper tubes, mechanically expanded into aluminium fins, providing maximum heat transfer efficiency, durability and hygiene.

4 Flexible installation

Various types of unit to fit your needs with flexible installation options. A choice of service side for hydraulic connections, piping configuration and horizontal or vertical installation for ducted units.

Offering a great range of capacities and performance, available in a wide range of designs, the fan coils are perfectly adapted to fit within almost any location. Whether the requirements are for cooling only, or for both heating and cooling, there is a fan coil to suit. With a variety of piping and fan configuration, the range is capable of meeting the most stringent of requirements. Line up available in AC and EC fans, it is possible to achieve both powerful performance, but with sustainability in mind.

Controllers with sophisticated designs, provide a user friendly interface while enabling an easy and low cost integration to building management systems.



PAW-FC-RC1

Optional wired remote controller for AC fan, 2-pipe and 4-pipe application.



PAW-FC-TC903

Optional wired remote controller for AC fan 2-pipe application.



PAW-FC-907TC

Optional wired remote controller for EC fan, 2-pipe and 4-pipe application.

Smart fan coils

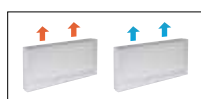

Built-in advanced thermostat.

		PAW-AAIR-200-2	PAW-AAIR-700-2	PAW-AAIR-900-2	
Total cooling capacity	Lo/Med/Hi	kW	0.2/0.3/0.6	0.8/1.0/1.2	1.2/1.5/1.7
Sensible cooling capacity	Lo/Med/Hi	kW	0.2/0.3/0.5	0.6/0.9/1.1	1.1/1.4/1.6
Water flow	Lo/Med/Hi	kg/h	40.0/59.0/95.0	129.0/178.0/207.0	198.0/261.0/300.0
Water pressure drop	Lo/Med/Hi	kPa	0.4/2.0/2.9	1.0/2.0/2.0	6.0/9.0/12.0
Inlet water temperature		°C	10	10	10
Outlet water temperature		°C	15	15	15
Inlet air temperature		°C	27.0	27.0	27.0
Outlet air temperature	Lo/Med/Hi	°C	15.0/17.0/18.0	14.0/16.0/17.0	16.0/17.0/18.0
Relative humidity of inlet air		%	47	47	47
Total heating capacity	Lo/Med/Hi	kW	0.2/0.5/0.6	0.7/1.0/1.2	0.9/1.4/1.7
Water flow	Lo/Med/Hi	kg/h	37.3/80.8/98.0	121.8/177.5/204.3	152.4/244.2/292.9
Water pressure drop	Lo/Med/Hi	kPa	0.4/2.0/2.9	0.3/0.8/1.0	0.5/1.6/2.2
Inlet water temperature		°C	35	35	35
Outlet water temperature		°C	30	30	30
Inlet air temperature		°C	19.0	19.0	19.0
Outlet air temperature	Lo/Med/Hi	°C	38.9/32.0/30.0	33.3/31.8/30.6	30.2/31.1/30.6
Air flow	Lo/Med/Hi	m ³ /sec	0.02/0.03/0.05	0.04/0.07/0.09	0.07/0.10/0.13
Maximum input power	Lo/Med/Hi	W	7.0/9.0/13.0	14.0/18.0/22.0	16.0/20.0/24.0
Sound pressure	Lo/Med/Hi	dB(A)	23/33/40	24/36/42	25/36/44
Dimension (HxWxD)		mm	735x579x129	935x579x129	1135x579x129
Net weight		kg	17	20	23
3 Ways valve included			Yes	Yes	Yes
Touch screen thermostat			Yes	Yes	Yes
RRP		£	665	720	861

* Smart fan coils is produced by Innova.

Accessories	RRP £
PAW-AAIR-LEGS-1 Kits of 2 legs to protect the water pipings	51

Accessories	RRP £
PAW-AAIR-RHCABLE Motor connection cable for units with hydraulic connections on the right	24

Stylish floor-standing fan coils with advanced controller

The slimline of Smart fan coils delivers high efficiency climate control.

With a depth of just under 130 mm they are at the cutting edge of the market. Blending easily into the home, Smart fan coil's elegant design and product refinements are clear to see in every detail.

Exceptional ventilation efficiency means the motor uses considerably less energy (low wattage). The fan speed is continuously modulated by the temperature controller with proportional integral logic, with undoubted advantages for regulating the temperature and humidity in summer mode.

Technical focus

- 4 operation modes (auto, silent, night-time and maximum ventilation speed)
- Exclusive design
- Extremely compact (only 129 mm deep)
- Cooling and dehumidification functions possible (drain is needed)
- 3-way valve included (no overflow valve needed on the installation if more than 3 units installed)
- Touch screen thermostat

With standard cast radiators.

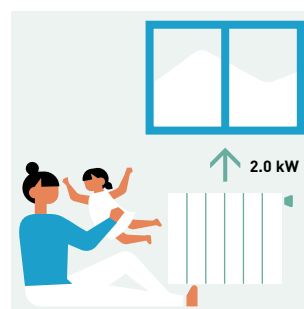

Water at 65 °C needed.

With Smart fan coil.

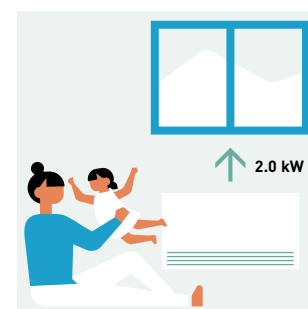

Water at 35 °C needed.

All temperature curves and capacity are available on www.panasonicproclub.com

PRO Club 



Fan coils - ducted (AC)



Optional controller.
Wired remote controller.
PAW-FC-903TC



Optional controller.
Advanced wired remote controller.
PAW-FC-RC1

Left connection (PAW-)			FC2A-D010L	FC2A-D020L	FC2A-D030L	FC2A-D040L	FC2A-D050L	FC2A-D060L	FC2A-D070L	FC2A-D080L
Right connection (PAW-)			FC2A-D010R	FC2A-D020R	FC2A-D030R	FC2A-D040R	FC2A-D050R	FC2A-D060R	FC2A-D070R	FC2A-D080R
Total cooling capacity ¹⁾	Lo/Med/Hi	kW	0.7/1.0/1.5	0.7/1.2/1.7	1.0/2.0/2.5	1.2/2.4/3.2	1.7/3.2/4.6	2.7/4.6/5.8	3.4/6.1/7.3	4.6/6.1/8.1
Sensible cooling capacity ¹⁾	Lo/Med/Hi	kW	0.5/0.8/1.1	0.6/0.9/1.3	0.8/1.5/1.9	0.9/1.8/2.3	1.2/2.2/3.3	1.9/3.3/4.5	2.4/4.3/5.1	3.4/4.6/6.3
Water flow	Lo/Med/Hi	l/h	124/172/250	127/213/289	172/341/430	206/413/547	296/544/798	466/784/1003	587/1058/1252	798/1048/1400
Water pressure drop	Lo/Med/Hi	kPa	10.7/19.5/39.2	1.9/3.9/6.3	6.3/19.3/28.8	5.4/17.1/28.0	7.5/22.8/46.9	13.9/37.4/60.2	4.8/15.4/21.5	11.9/19.3/32.5
Heating capacity ²⁾	Lo/Med/Hi	kW	0.9/1.4/2.0	0.9/1.5/2.2	1.3/2.4/3.1	1.4/2.9/4.0	2.1/4.1/5.7	3.1/5.3/7.1	4.3/7.9/9.3	5.9/8.1/11.6
Sound levels										
Global sound power	Lo/Med/Hi	dB(A)	33/40/49	31/43/50	30/45/52	30/44/51	34/46/56	38/51/58	43/56/61	50/55/64
Global sound pressure ³⁾	Lo/Med/Hi	dB(A)	24/31/40	22/34/41	21/36/43	21/35/42	25/37/47	29/42/49	34/47/52	41/46/55
Fan										
Number			1	1	1	2	2	2	2	3
Air flow	Lo/Med/Hi	m ³ /sec	0.03/0.05/0.08	0.03/0.05/0.07	0.04/0.08/0.11	0.05/0.10/0.14	0.07/0.14/0.20	0.10/0.18/0.26	0.13/0.25/0.30	0.18/0.26/0.39
Maximum external pressure		Pa	55	55	65	85	85	115	125	70
Filter			G2	G2	G2	G2	G2	G2	G2	G2
Electrical data										
Power supply	Voltage	V	230	230	230	230	230	230	230	230
	Phase		Single phase	Single phase	Single phase	Single phase	Single phase	Single phase	Single phase	Single phase
	Frequency	Hz	50/60	50/60	50/60	50/60	50/60	50/60	50/60	50/60
Power consumption	Lo/Med/Hi	W	13/24/36	10/18/29	16/37/45	15/37/56	28/55/72	37/75/105	53/100/147	90/112/188
Water connections										
Type			Female gas threaded	Female gas threaded	Female gas threaded	Female gas threaded	Female gas threaded	Female gas threaded	Female gas threaded	Female gas threaded
Water connections	Inch		1/2	1/2	1/2	1/2	1/2	1/2	3/4	3/4
Dimensions and weight										
Dimension	H x W x D	mm	220 x 570 x 430	220 x 570 x 430	220 x 730 x 430	220 x 938 x 430	220 x 1122 x 430	220 x 1307 x 430	220 x 1121 x 530	220 x 1316 x 530
Weight		kg	13	13	15	20	22	26	27	38
RRP		£	276	290	310	361	404	437	497	712

1) According to Eurovent standard. Air: 27 °C DB / 19 °C WB. Water in / out: 7 °C / 12 °C. 2) Air: 20 °C. Water in / out: 50 °C / 45 °C. 3) The sound pressure levels are based on (NR) characteristics of a room having volume of 100 m³ with reverberation of 0.5 seconds. Values indicated are for 0 Pa external static pressure, for additional pressure characteristics, please refer the selection software.

Accessories	RRP £
PAW-FC-RC1 Advanced wired remote controller for fan coil	90
PAW-FC-903TC Wired remote controller for fan coil	81
PAW-FC-2WY-11/55-1 2 way valve + drain pan for models 010-060	63

Accessories	RRP £
PAW-FC-2WY-65/90-1 2 way valve + drain pan for models 070-080	72
PAW-FC-3WY-11/55-1 3 way valve + drain pan for models 010-060	93
PAW-FC-3WY-65/90-1 3 way valve + drain pan for models 070-080	104

Technical focus

- Cooling capacity from 0.7 to 8.1 kW
- Heating capacity from 0.7 to 10.3 kW
- 5-speed AC fan motor(s)

Main features and accessories

- 2 and 4-pipe configurations
- Left or right hand arrangements
- Ease of installation
- Very low acoustic levels
- 2 way or 3 way ON / OFF valves
- Auxiliary drain pan
- Air intake with removable grid
- G2 filter

Operating limits	
Entering water temperature	From 5 to 90 °C
Indoor air temperature	From 5 to 32 °C



Fan coils - wall-mounted (AC)



Optional controller.
Wired remote controller.
PAW-FC-903TC



Optional controller.
Advanced wired remote controller.
PAW-FC-RC1



Infrared remote supplied with IR versions.
IR Controller

2-pipe			PAW-FC2A-K007	PAW-FC2A-K009	PAW-FC2A-K018	PAW-FC2A-K022
			PAW-FC2A-K007IR	PAW-FC2A-K009IR	PAW-FC2A-K018IR	PAW-FC2A-K022IR
Total cooling capacity ¹⁾	Lo/Med/Hi	kW	1.0/1.3/1.7	1.6/1.7/2.4	2.8/3.0/3.5	2.9/3.1/3.9
Sensible cooling capacity ¹⁾	Lo/Med/Hi	kW	0.7/1.0/1.2	1.2/1.3/1.9	2.1/2.3/2.7	2.3/2.5/3.1
Water flow	Lo/Med/Hi	l/h	172/231/287	270/291/418	483/508/609	502/535/669
Water pressure drop	Lo/Med/Hi	kPa	18.6/24.9/30.9	18.5/27.0/40.0	34.6/41.3/55.6	37.2/33.7/45.2
Heating capacity ²⁾	Lo/Med/Hi	kW	1.4/1.7/2.0	1.7/2.0/2.7	2.9/3.2/4.0	3.1/3.7/4.4
Sound levels						
Sound power	Lo/Med/Hi	dB(A)	45/49/51	47/52/57	49/53/59	56/59/63
Sound pressure ³⁾	Lo/Med/Hi	dB(A)	32/36/38	34/39/44	40/43/46	43/46/50
Fan						
Number			1	1	1	1
Air flow	Lo/Med/Hi	m ³ /sec	0.08/0.09/0.10	0.10/0.11/0.15	0.15/0.16/0.19	0.17/0.20/0.24
Filter			G1	G1	G1	G1
Electrical data						
Power supply	Voltage	V	230	230	230	230
	Phase		Single phase	Single phase	Single phase	Single phase
	Frequency	Hz	50	50	50	50
Fuse rating		A	3	3	3	3
Power consumption	Lo/Med/Hi	W	39/42/62	30/47/59	44/50/55	50/55/70
Water connections						
Type			Female gas threaded	Female gas threaded	Female gas threaded	Female gas threaded
Water connections		Inch	1/2	1/2	1/2	1/2
Dimensions and weight						
Dimension	HxWxD	mm	275x180x845	275x180x845	298x200x940	298x200x940
Weight		kg	11	11	13	13
RRP		£	383	423	476	517
RRP with IR Controller		£	423	459	506	553

1) According to Eurovent standard. Air: 27 °C DB / 19 °C WB. Water in / out: 7 °C / 12 °C. 2) According to Eurovent standard. Air: 20 °C. Water in / out: 45 °C / 40 °C. 3) Sound pressure considering a local of 100 m³ a reverberation time of 0.5 seconds and a distance of 1 m.

Accessories	RRP £
PAW-FC-RC1 Advanced wired remote controller for fan coil	90
PAW-FC-903TC Wired remote controller for fan coil	81

Accessories	RRP £
PAW-FC2-2WY-K007 2 way valve	75
PAW-FC2-3WY-K007 3 way valve	120

Technical focus

- 4 sizes
- Cooling capacity from 1.0 to 3.9 kW
- Heating capacity from 1.4 to 4.1 kW
- Version: 2-pipes, AC fan

Main features and accessories

- 2 way or 3 way valve ON / OFF
- 3-speed AC fan motor
- Silent unit for optimum customer comfort
- Aesthetic design suitable for residential and hotel applications
- Compatible with IR controller (supplied with IR versions)
- Coil with hydrophilic fins to improve the condensate flow

Operating limits

Entering water temperature	From 5 to 60 °C
Indoor air temperature	From 6 to 40 °C



Accessories and control

Distribution joint kits





2-Pipe ME2 for outdoor units (up to 68,0 kW). ----- CZ-P680PH2BM 160 €	2-Pipe ME2 for outdoor units (from 68,0 kW to 168,0 kW). ----- CZ-P1350PH2BM 221 €	2-Pipe ME2 and Mini ECOi for indoor units (up to 22,4 kW*). ----- CZ-P224BK2BM 91 €
2-Pipe ME2 for indoor units (from 22,4 kW to 68,0 kW*). ----- CZ-P680BK2BM 151 €	2-Pipe ME2 for indoor units (from 68,0 kW to 135,0 kW*). ----- CZ-P1350BK2BM 205 €	3-Pipe MF3 for outdoor units (up to 68,0 kW). ----- CZ-P680PJ2BM 274 €
3-Pipe MF3 for outdoor units (from 68,0 kW to 168,0 kW). ----- CZ-P1350PJ2BM 469 €	3-Pipe MF3 for indoor units (up to 22,4 kW). ----- CZ-P224BH2BM 107 €	3-Pipe MF3 for indoor units (from 22,4 kW to 68,0 kW). ----- CZ-P680BH2BM 270 €
3-Pipe MF3 for indoor units (up to 68,0 kW). ----- CZ-P1350BH2BM 285 €	2-Pipe ME2 header pipe. ----- CZ-P4HP4C2BM 172 €	3-Pipe MF3 header pipe. ----- CZ-P4HP3C2BM 253 €

* In case the total capacity of indoor units connected after distribution exceeds the total capacity of the outdoor units, select the distribution piping size for the total capacity of the outdoor units.

Heat recovery box

3-Pipe control Solenoid valve kit (up to 5.6 kW). CZ-P56HR3 + CZ-CAPE2. ----- KIT-P56HR3 497 €	 Solenoid valve kit (up to 5.6 kW). ----- CZ-P56HR3 409 €	 3-Pipe control PCB. ----- CZ-CAPE2 91 €
3-Pipe control Solenoid valve kit (from 5.6 to 16.0 kW). CZ-P160HR3 + CZ-CAPE2. ----- KIT-P160HR3 586 €	Solenoid valve kit (from 5.6 kW to 16.0 kW). ----- CZ-P160HR3 497 €	3-Pipe control PCB for wall-mounted. ----- CZ-CAPEK2 99 €
 4 ports 3 pipe box (up to 5.6 kW per port). ----- CZ-P456HR3 2.495 €	 6 ports 3 pipe box (up to 5.6 kW per port). ----- CZ-P656HR3 3.424 €	 8 ports 3 pipe box (up to 5.6 kW per port). ----- CZ-P856HR3 4.667 €
4 ports 3 pipe box (up to 16.0 kW per port). ----- CZ-P4160HR3 2.781 €		

Panels

 Standard panel for 4 way 90x90 cassette. ----- CZ-KPU3W 204 €	 Econavi panel for 4 way 90x90 cassette. ----- CZ-KPU3AW 278 €	 Panel for 60x60 cassette - PY2 size 700x700 mm. ----- CZ-KPY3AW 233 €	 Panel for 60x60 cassette - PY2 size 625x625 mm. ----- CZ-KPY3BW 224 €
---	---	--	--

Panel for 4 way 60x60 cassette - PY3.	Panel for 2 way cassette (for S-22 to S-56 models).	Panel for 2 way cassette (for S-73 model).	Panel for 1 way cassette.
CZ-KPY4 233 €	CZ-02KPL2 362 €	CZ-03KPL2 431 €	CZ-KPD2 381 €

Sensors

Panasonic R32 refrigerant leak detector for MU2, MY2, MK2, MF3 and MM1 models.	Econavi energy savings sensor.	Remote temperature sensor.
CZ-CGLSC1 160 €	CZ-CENSC1 151 €	CZ-CSRC3 108 €

Plenums

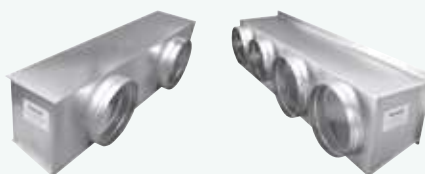

Air inlet plenum for S .MF3E5B, S .MF3E5A and S .MF2E5A 15, 22, 28, 36, 45 and 56.	Air inlet plenum for S .MM1E5B 22, 28, 36, 45 and 56.	Air outlet plenum for S-224ME1E5A / S-280ME1E5.
CZ-DUMPA56MF2 250 €	CZ-DUMPA22MMR2 276 €	CZ-TREMIESPW706 731 €
Air inlet plenum for S .MF3E5B, S .MF3E5A and S .MF2E5A 60, 73 and 90.	Air outlet plenum for S .MM1E5B 22, 28 and 36.	
CZ-DUMPA90MF2 271 €	CZ-DUMPA22MMS2 432 €	
Air inlet plenum for S .MF3E5B, S .MF3E5A and S .MF2E5A 106, 140 and 160.	Air outlet plenum for S .MM1E5B 45 and 56.	
CZ-DUMPA160MF2 291 €	CZ-DUMPA45MMS3 554 €	



* Plenums installed with an R32 Mini ECOi system may only be used when no Panasonic R32 refrigerant leak detector is required. Please refer to technical data manual for refrigerant installation requirements.

Valves



E2 Type high static pressure hide-away rap valve kit for 100 % Fresh air function.	Wall-mounted external valve for model sizes 15 to 56.	Wall-mounted external valve for model sizes 73 to 106.
CZ-P160RVK2 588 €	CZ-P56SVK2 180 €	CZ-P160SVK2 227 €

Accessories and control

VRF Smart Connectivity+

 <p>Remote controller Panasonic Net Con, RH, No PIR, R1/R2.</p> <p>----- SER8150R0B1194</p> <p>----- 517 €</p>	<p>Remote controller Panasonic Net Con, RH, PIR, R1/R2.</p> <p>----- SER8150R5B1194</p> <p>----- 552 €</p>	 <p>Wireless ZigBee® Pro module / Green Com card.</p> <p>----- VCM8000V5094P</p> <p>----- 185 €</p>
--	---	---

 <p>Hotel Room Expansion Module 14 indoor units.</p> <p>----- HRCEP14R</p> <p>----- 328 €</p> <p>Hotel Room Controller 28 indoor units.</p> <p>----- HRCPBG28R</p> <p>----- 873 €</p>	<p>Hotel Room Controller w/ Display 42 indoor units.</p> <p>----- HRCPDG42R</p> <p>----- 1.113 €</p>	 <p>Door / window wireless sensor.</p> <p>----- SED-WDC-G-5045</p> <p>----- 212 €</p>	 <p>Wall / ceiling (motion) wireless sensor.</p> <p>----- SED-MTH-G-5045</p> <p>----- 259 €</p>
--	---	--	---

 <p>CO₂ sensor.</p> <p>----- SED-CO2-G-5045</p> <p>----- 667 €</p>	 <p>Sensor with room temperature and humidity.</p> <p>----- SED-TRH-G-5045</p> <p>----- 209 €</p>	 <p>Water leakage sensor.</p> <p>----- SED-WLS-G-5045</p> <p>----- 202 €</p>
---	---	--



<p>Cover frame. Silver.</p> <p>----- FAS-00</p> <p>----- 42 €</p> <p>Cover frame. White.</p> <p>----- FAS-01</p> <p>----- 42 €</p>	<p>Cover frame. Glossy translucent white.</p> <p>----- FAS-03</p> <p>----- 76 €</p> <p>Cover frame. Light tan wood.</p> <p>----- FAS-05</p> <p>----- 59 €</p>	<p>Cover frame. Dark brown wood.</p> <p>----- FAS-06</p> <p>----- 59 €</p> <p>Cover frame. Dark black wood.</p> <p>----- FAS-07</p> <p>----- 59 €</p>	<p>Cover frame. Brushed steel finish.</p> <p>----- FAS-10</p> <p>----- 76 €</p>
--	---	---	--



Controller and touch controllers for hotels with dry contacts

	
<p>Modbus RS-485 touch room controller with I/O, white.</p> <p>-----</p> <p>PAW-RE2C4-MOD-WH 444 €</p>	<p>Modbus RS-485 touch room controller with I/O, black.</p> <p>-----</p> <p>PAW-RE2C4-MOD-BK 444 €</p>
<p>Touch display control with 2 digital inputs, white.</p> <p>-----</p> <p>PAW-RE2D4-WH 271 €</p>	<p>Touch display control with 2 digital inputs, black.</p> <p>-----</p> <p>PAW-RE2D4-BK 271 €</p>

Hotel sensors for dry contacts

			
<p>Wall motion sensor 24 V.</p> <p>-----</p> <p>PAW-WMS-DC 185 €</p>	<p>Ceiling motion sensor 24 V.</p> <p>-----</p> <p>PAW-CMS-DC 185 €</p>	<p>Power supply 24 V.</p> <p>-----</p> <p>PAW-24DC 59 €</p>	<p>Door or window contact.</p> <p>-----</p> <p>PAW-DWC 19 €</p>
<p>Wall motion sensor 240 V AC.</p> <p>-----</p> <p>PAW-WMS-AC 185 €</p>	<p>Ceiling motion sensor 240 V AC.</p> <p>-----</p> <p>PAW-CMS-AC 185 €</p>		

Centralised controls

		
<p>System controller for 64 indoor units with weekly timer.</p> <p>-----</p> <p>CZ-64ESMC3 764 €</p>	<p>Central ON / OFF controller, up to 16 groups, 64 indoor units.</p> <p>-----</p> <p>CZ-ANC3 517 €</p>	<p>Intelligent controller (touch screen/web server) to control up to 256 indoors with included load distribution ratio (LDR).</p> <p>-----</p> <p>CZ-256ESMC3 2.867 €</p>

Centralised controls. BMS system. PC base

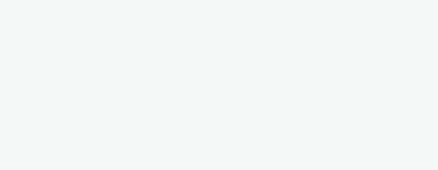
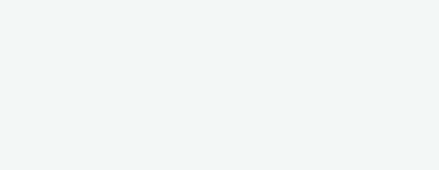
		
<p>P-AIMS core software: Centralised software to control up to 1024 indoor units.</p> <p>-----</p> <p>CZ-CSWKC2 4.147 €</p>	<p>P-AIMS consumption calculation extension.</p> <p>-----</p> <p>CZ-CSWAC2 2.370 €</p>	<p>P-AIMS BACnet extension.</p> <p>-----</p> <p>CZ-CSWBC2 4.739 €</p>
<p>P-AIMS communication adaptor.</p> <p>-----</p> <p>CZ-CFUNC2 1.205 €</p>	<p>P-AIMS layout display extension.</p> <p>-----</p> <p>CZ-CSWGC2 1.778 €</p>	<p>P-AIMS web application extension.</p> <p>-----</p> <p>CZ-CSWWC2 1.778 €</p>

Accessories and control

Panasonic AC Smart Cloud



Panasonic AC Smart Cloud. Cloud internet control. Up to 128 groups. Controls 128 units.

CZ-CFUSCC1

445 €

Accessories interfaces



Modbus RTU and TCP interface for 16 indoor units.

PAW-AC2-MBS-16P

2.237 €



KNX interface for 16 indoor units.

PAW-AC2-KNX-16P

2.237 €



BACnet IP and MSTP interface for 16 indoor units.

PAW-AC2-BAC-16P

2.237 €

Modbus RTU and TCP interface for 64 indoor units.

PAW-AC2-MBS-64P

3.211 €

KNX interface for 64 indoor units.

PAW-AC2-KNX-64P

3.211 €

BACnet IP and MSTP interface for 64 indoor units.

PAW-AC2-BAC-64P

3.211 €

Modbus RTU and TCP interface for 128 indoor units.

PAW-AC2-MBS-128P

4.300 €

BACnet IP and MSTP interface for 128 indoor units.

PAW-AC2-BAC-128P

4.300 €



Commercial Wi-Fi Adaptor.

CZ-CAPWFC1

176 €



KNX interface.

PAW-RC2-KNX-1i

347 €



Modbus RTU interface.

PAW-RC2-MBS-1

347 €



Modbus RTU interface to control 4 indoor/groups.

PAW-RC2-MBS-4

804 €



BACnet IP and MSTP.

PAW-RC2-BAC-1

574 €



RAC interface adapter for integration into P-Link, plus external input and alarm/status output.

CZ-CAPRA1

163 €



LonWorks® Interface controls up to 16 groups and 64 indoor units.

CZ-CLNC2

1.205 €

Centralised controls. Connection with general equipment

<p>Adaptor for ON / OFF control of external devices.</p>	<p>Mini series parallel device controlling indoor units, maximum 1 group and 8 indoor unit.</p>	<p>Communication Adaptor. Up to 128 groups. Controls 128 units.</p>			
<p>CZ-CAPC3</p>	<p>328 €</p>	<p>CZ-CAPBC2</p>	<p>275 €</p>	<p>CZ-CFUNC2</p>	<p>1.205 €</p>



Individual controls

<p>CONEX wired remote controller (non-wireless).</p>	<p>CONEX wired remote controller with Bluetooth®.</p>	<p>Design wired remote controller with Econavi function.</p>			
<p>CZ-RTC6</p>	<p>144 €</p>	<p>CZ-RTC6BL</p>	<p>172 €</p>	<p>CZ-RTC5B</p>	<p>144 €</p>
<p>Infrared remote controller and receiver for 4 way 90x90 cassette.</p>	<p>Infrared remote controller for wall-mounted, 4 way 60x60 with panel and floor console.</p>	<p>Infrared remote controller and receiver for 2 way cassette.</p>			
<p>CZ-RWS3 + CZ-RWRU3W</p>	<p>276 €</p>	<p>CZ-RWS3</p>	<p>108 €</p>	<p>CZ-RWS3 + CZ-RWRL3</p>	<p>276 €</p>
<p>Infrared remote controller and receiver for 1 way cassette.</p>	<p>Infrared remote controller and receiver for ceiling.</p>	<p>Infrared remote controller and receiver for all indoor units.</p>			
<p>CZ-RWS3 + CZ-RWRD3</p>	<p>276 €</p>	<p>CZ-RWS3 + CZ-RWRT3</p>	<p>276 €</p>	<p>CZ-RWS3 + CZ-RWRC3</p>	<p>276 €</p>

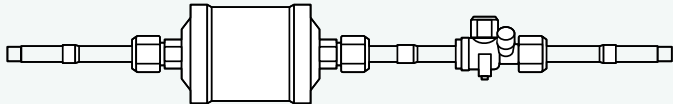
Accessories and control

Accessories PCB		R-22 Replacement Kit	
			
T10 interface PCB with digital and relay connections.		Replacement kit for R-22.	
PAW-T10	100 €	CZ-SLK2	357 €
PCB for fan speed control of external EC Fan.			
PAW-ECF	530 €		

Accessories cables

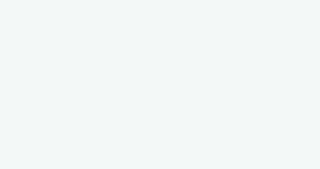
			
Cable for all the T10 functions.	Cable to operate external EC fan.	Cable for all option monitoring signals.	Cable with force thermo OFF/leakage detection.
CZ-T10	PAW-FDC	PAW-OCT	PAW-EXCT
47 €	47 €	47 €	47 €

Water heat exchanger accessories

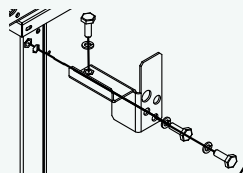

Stacking kit for vertically stacking up to 3 WHE (4 pieces per Kit).

PAW-3WSK

182 €



PRO-HT Tank accessories

Tank Controller for ECOi system.	Expansion valve kit 16 kW.	Expansion valve kit 28 kW.
PAW-VP-RTC5B-VRF	PAW-VP-VALV-160	PAW-VP-VALV-280
1.385 €	40 €	103 €

Smart fan coil accessories

Kits of 2 legs to protect the water pipings.	Motor connection cable for units with hydraulic connections on the right.
-----	-----
PAW-AAIR-LEGS-1	PAW-AAIR-RHCABLE
51 €	24 €

Fan coil accessories

		
Wired remote controller for fan coil.	Advanced wired remote controller for fan coil.	Infrared remote supplied with IR versions.
-----	-----	-----
PAW-FC-903TC	PAW-FC-RC1	IR Controller
81 €	90 €	Included with IR models
2 way valve + drain pan for ducted models 010-060.	2 way valve + drain pan for ducted models 070-080.	2 way valve for wall-mounted.
-----	-----	-----
PAW-FC-2WY-11/55-1	PAW-FC-2WY-65/90-1	PAW-FC2-2WY-K007
63 €	72 €	75 €
3 way valve + drain pan for ducted models 010-060.	3 way valve + drain pan for ducted models 070-080.	3 way valve for wall-mounted.
-----	-----	-----
PAW-FC-3WY-11/55-1	PAW-FC-3WY-65/90-1	PAW-FC2-3WY-K007
93 €	104 €	120 €

4. CZ-P680BK2BM

For indoor unit side (capacity after distribution joint is greater than 22,4 kW and no more than 68,0 kW).

Gas piping

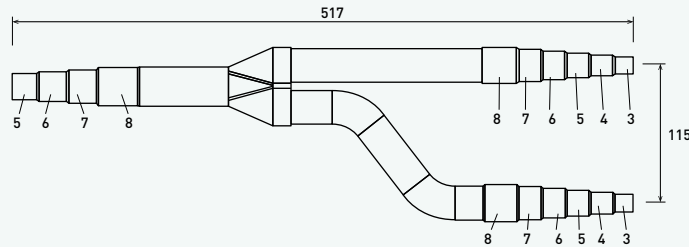

Liquid piping

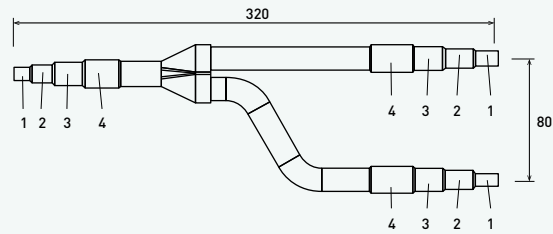

Unit: mm

5. CZ-P1350BK2BM

For indoor unit side (capacity after distribution joint is greater than 68,0 kW and no more than 168,0 kW).

Gas piping

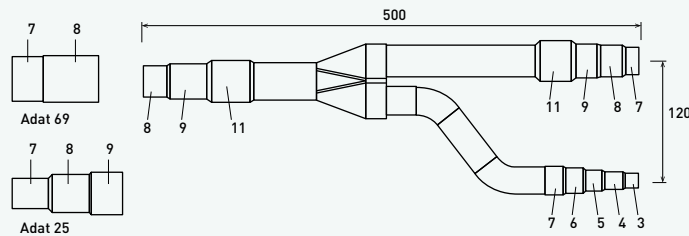

Liquid piping

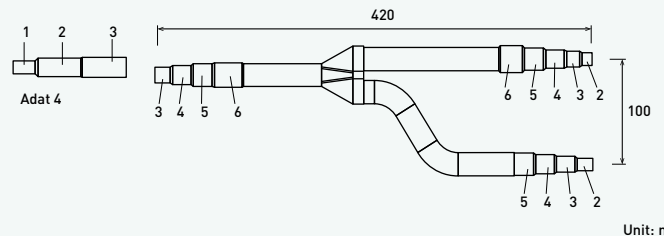

Unit: mm

Header pipe set for ECOi EX 2-Pipe

CZ-P4HP4C2BM

Header pipe models for 2-Pipe Series.

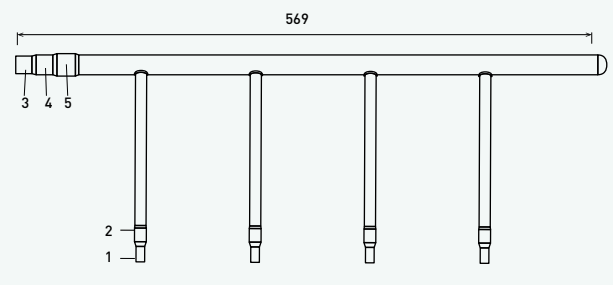
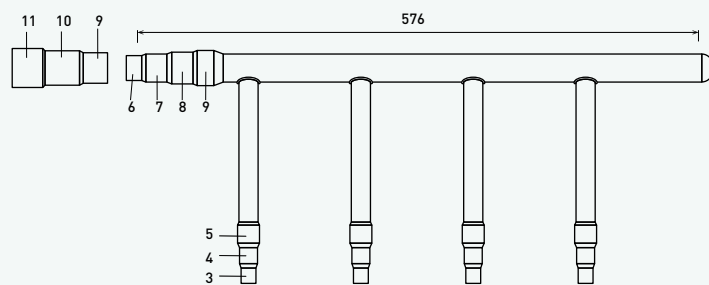

Distribution joint Kits for Mini ECOi LE/LZ Series

CZ-P224BK2BM

For indoor unit side (capacity after distribution joint is 22,4 kW or less).

Gas piping

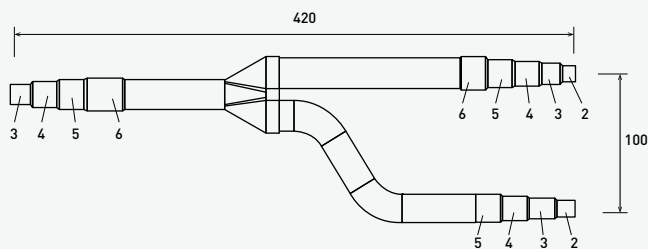

Liquid piping

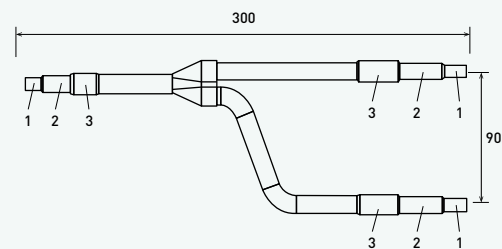

Unit: mm

Size of connection point on each part (shown are inside diameters of piping)

Diameters		1	2	3	4	5	6	7	8	9	10	11	12	13	14
Dimension	Inch	1/4	3/8	1/2	5/8	3/4	7/8	1	1 1/8	1 1/4	13/8	11/2	15/8	13/4	2
	mm	6,35	9,52	12,70	15,88	19,05	22,40	25,40	28,57	31,75	34,92	38,10	41,28	44,45	50,80

Dimensions and tube sizes of branches and headers for ECOi EX 3-Pipe Series

Optional distribution joint kits

See the installation instructions packaged with the distribution joint kit for the installation procedure.

* In case the total capacity of indoor units connected after distribution exceeds the total capacity of the outdoor units, select the distribution piping size for the total capacity of the outdoor units.

Model name	Cooling capacity after distribution	Remarks
1. CZ-P680PJ2BM	68,0 kW or less	For outdoor unit
2. CZ-P1350PJ2BM	Greater than 68,0 kW and no more than 135,0 kW	For outdoor unit
3. CZ-P224BH2BM	22,4 kW or less	For indoor unit
4. CZ-P680BH2BM	Greater than 22,4 kW and no more than 68,0 kW	For indoor unit
5. CZ-P1350BH2BM	Greater than 68,0 kW and no more than 135,0 kW	For indoor unit

Piping size for 3-Pipe ECOi EX MF3 Series

1. CZ-P680PJ2BM

For outdoor unit side (capacity after distribution joint is 68,0 kW or less).

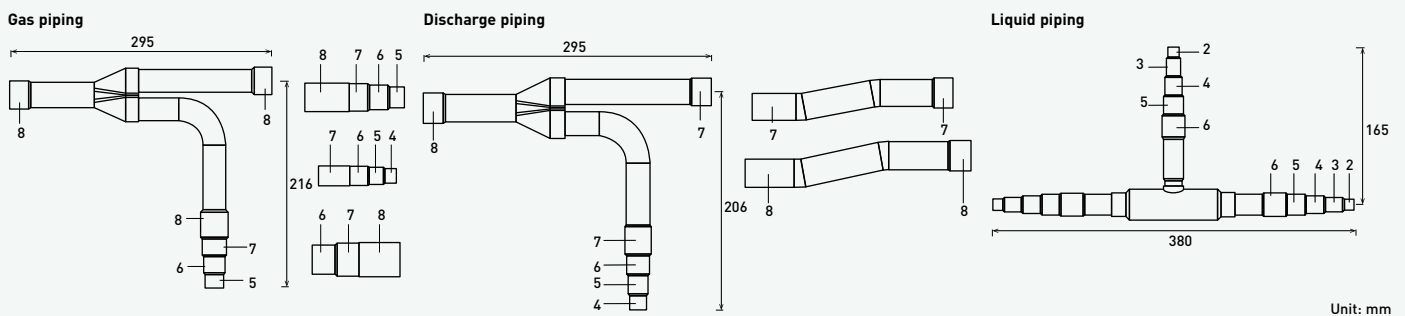

Unit: mm

2. CZ-P1350PJ2BM

For outdoor unit side (capacity after distribution joint is greater than 68,0 kW and no more than 135,0 kW).

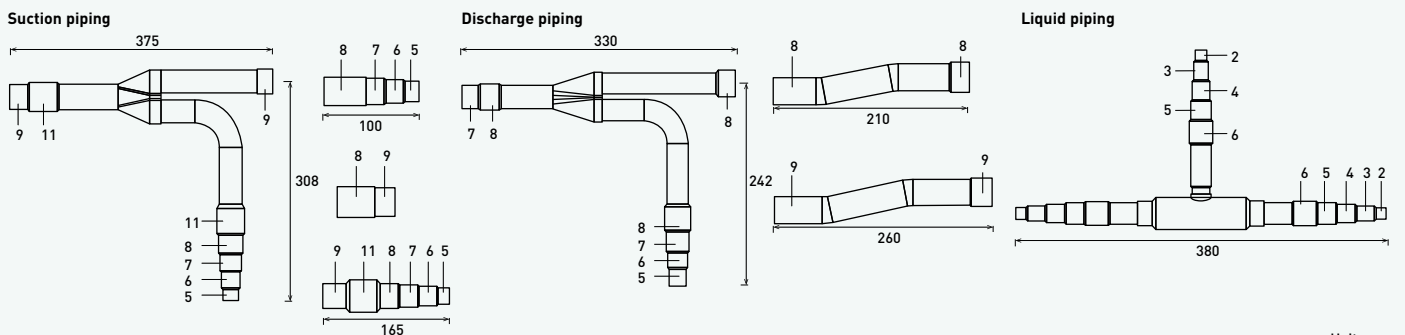

Unit: mm

3. CZ-P224BH2BM

For indoor unit side (capacity after distribution joint is 22,4 kW or less).

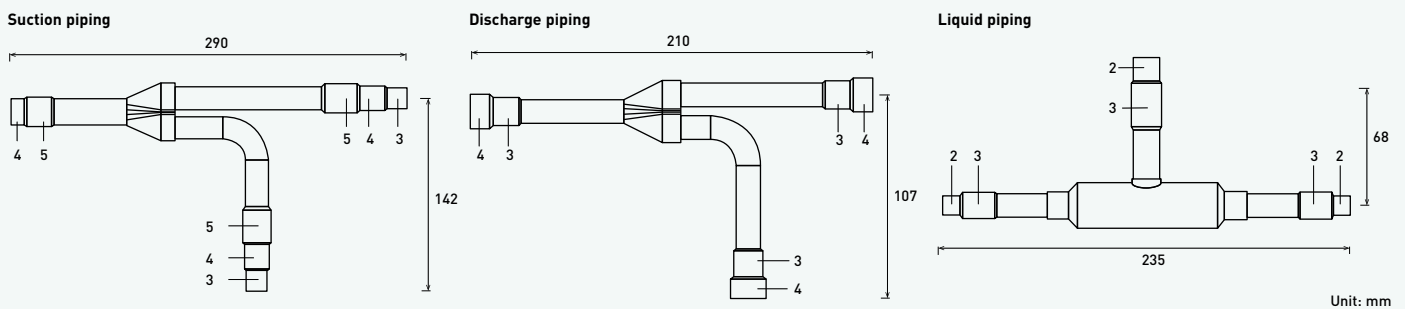

Unit: mm

4. CZ-P680BH2BM

For indoor unit side (capacity after distribution joint is greater than 22,4 kW and no more than 68,0 kW).

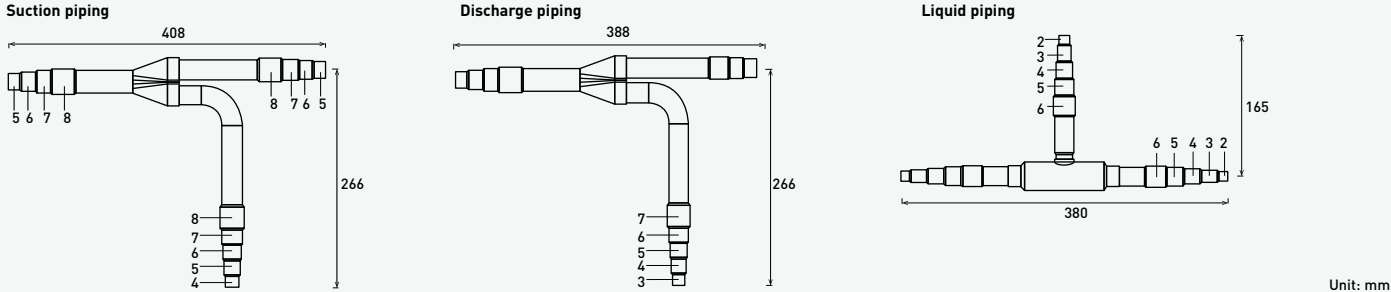

Unit: mm

5. CZ-P1350BH2BM

For indoor unit side (capacity after distribution joint is greater than 68,0 kW and no more than 135,0 kW).

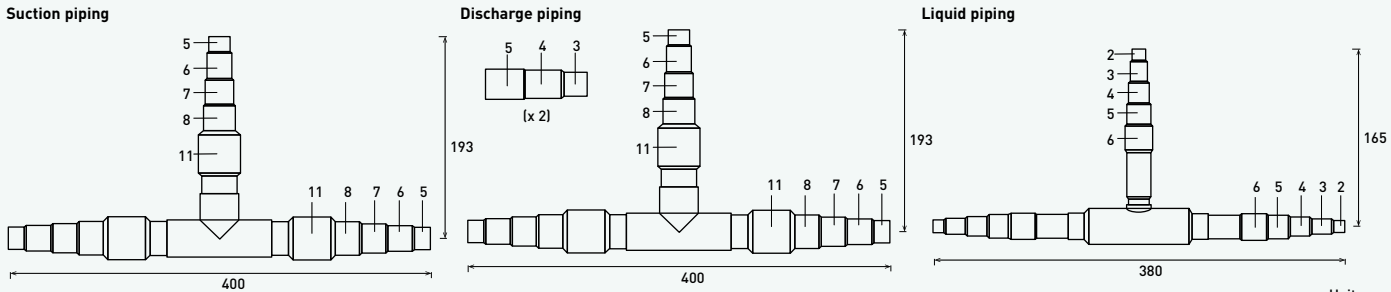

Unit: mm

Header pipe set for ECOi EX 3-Pipe

CZ-P4HP3C2BM

Header pipe model for 3-Pipe Series.

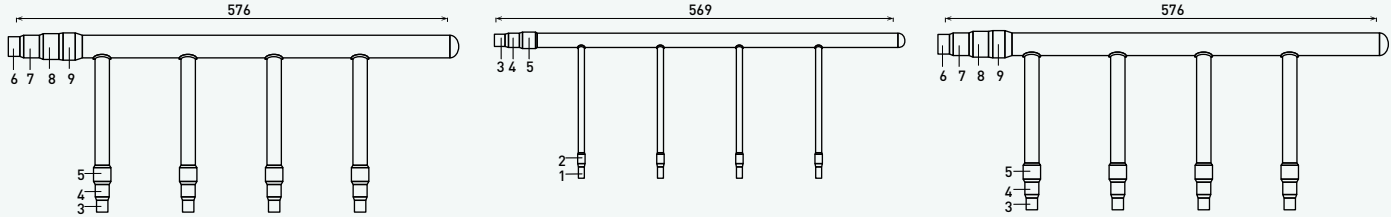

Size of connection point on each part (shown are inside diameters of piping)															
Diameters		1	2	3	4	5	6	7	8	9	10	11	12	13	14
Dimension	Inch	1/4	3/8	1/2	5/8	3/4	7/8	1	1 1/8	1 1/4	13/8	11/2	15/8	13/4	2
	mm	6,35	9,52	12,70	15,88	19,05	22,40	25,40	28,57	31,75	34,92	38,10	41,28	44,45	50,80



Panasonic ventilation solutions

Panasonic ventilation solutions for maximum savings and easy integration.

Air handling unit connection kit	→ 156
AHU connection kit 3.6 to 25.0 kW for PACi NX and PACi	→ 157
AHU connection kit 16.0 to 56.0 kW for ECOi and ECO G	→ 157
Energy recovery ventilation	→ 158
Electric air curtains	→ 160
Air curtain with DX coil, connected to PACi systems	→ 162
Air curtain with DX coil, connected to VRF systems	→ 163

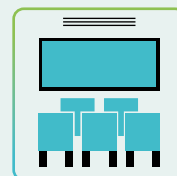
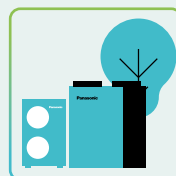
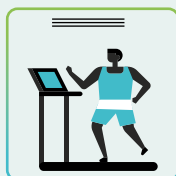
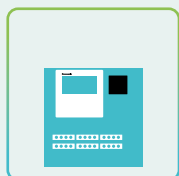

Air handling unit connection kit

AHU connection kits connect outdoor units to air handling systems. Combines air conditioning and fresh air in just one solution.

Application: Hotels, offices, server rooms or all large buildings where air quality control, such as humidity control and fresh air, is needed.



1 AHU connection kit 3,6 to 14,0 kW for PACi NX
CONEX Bluetooth® version (CZ-RTC6BL) is built-in. Easy connection and set-up is possible via Bluetooth®.

2 AHU connection kit 3.6 to 25.0 kW for PACi ¹⁾
1) Compatible with R32 models. Special setting is required.

3 AHU connection kit 16, 28 and 56 kW for ECOi and ECO G

3 types of AHU connection kit: Advanced, Medium and Light

	Model Code	IP 65	0-10 V demand control*	Outdoor temperature shift compensation. Cold draft prevention
PACi	PAW-280PAH3M-1	Yes	Yes	No
	PAW-280PAH2	Yes	Yes	Yes
	PAW-280PAH2M	Yes	Yes	No
	PAW-280PAH2L	Yes	No	No
ECOi and ECO G	PAW-160MAH2 / PAW-280MAH2 / PAW-560MAH2	Yes	Yes	Yes
	PAW-160MAH2M / PAW-280MAH2M / PAW-560MAH2M	Yes	Yes	No
	PAW-160MAH2L / PAW-280MAH2L / PAW-560MAH2L	Yes	No	No

* With CZ-CAPBC2.



AHU connection kit 3.6 to 25.0 kW for PACi NX and PACi

Models	PAW-	3.6 kW	5.0 kW	6.0 kW	7.5 kW	10.0 kW	12.5 kW	14.0 kW	20.0 kW	25.0 kW	
		280PAH3M-1	280PAH3M-1	280PAH3M-1	280PAH3M-1	280PAH3M-1	280PAH3M-1	280PAH3M-1	280PAH3M-1	280PAH3M-1	280PAH3M-1
Cooling capacity	kW	3.6	5.0	6.0	7.1	10.0	12.5	14.0	19.5	23.2	
Heating capacity	kW	4.0	5.6	7.0	8.0	11.2	14.0	16.0	22.4	28.0	
Air flow	Min / Max	m³/sec	0.15/0.24	0.18/0.28	0.22/0.37	0.22/0.37	0.25/0.60	0.32/0.63	0.33/0.67	0.60/1.20	0.63/1.40
Dimensions	H x W x D	mm	500 x 400 x 150	500 x 400 x 150	500 x 400 x 150	500 x 400 x 150	500 x 400 x 150	500 x 400 x 150	278 x 278 x 180	278 x 278 x 180	
Net weight	H3M / H2 & H2M / H2L	kg	11,5	11,5	11,5	11,5	11,5	11,5	11,50 / 4,25 / 3,98	11,50 / 4,25 / 3,98	
Pipe length range	Standard	m	3/15	3/20	3/40	3/40	5/50	5/50	5/50	—	
	Elite	m	3/40	3/40	3/40	5/50	5/85	5/85	5/85	5/90	5/60
Elevation difference (in / out)	Max	m	30	30	30	30	30	30	30	30	
Piping diameter	Liquid pipe	Inch (mm)	1/4 (6.35)	1/4 (6.35)	3/8 (9.52)	3/8 (9.52)	3/8 (9.52)	3/8 (9.52)	3/8 (9.52)	3/8 (9.52)	1/2 (12.70)
	Gas pipe	Inch (mm)	1/2 (12.70)	1/2 (12.70)	5/8 (15.88)	5/8 (15.88)	5/8 (15.88)	5/8 (15.88)	5/8 (15.88)	1 (25.40)	1 (25.40)
Intake temperature of AHU connection kit	Cool Min~Max	°C DB	18~32	18~32	18~32	18~32	18~32	18~32	18~32	18~32	
	Cool Min~Max	°C WB	14~25	14~25	14~25	14~25	14~25	14~25	—	—	
	Heat Min~Max	°C	16~30	16~30	16~30	16~30	16~30	16~30	16~30	16~30	
Ambient temperature of outdoor unit (Standard)	Cool Min~Max	°C	-10~+43	-10~+43	-10~+43	-10~+43	-10~+43	-10~+43	-10~+43	-10~+43	
	Heat Min~Max	°C	-15~+24	-15~+24	-15~+24	-15~+24	-15~+24	-15~+24	-15~+24	-15~+24	
Ambient temperature of outdoor unit (Elite)	Cool Min~Max	°C	-15~+46	-15~+46	-15~+46	-15~+46	-20~+48	-20~+48	-20~+48	-20~+48	
	Heat Min~Max	°C	-20~+24	-20~+24	-20~+24	-20~+24	-20~+24	-20~+24	-20~+24	-20~+24	
RRP Advanced	£	—	—	—	—	—	—	—	1.620	1.620	
RRP PAH3 Medium	£	1.574	1.574	1.574	1.574	1.574	1.574	1.574	1.574	1.574	
RRP PAH2 Medium	£	—	—	—	—	—	—	—	1.377	1.377	
RRP Light	£	—	—	—	—	—	—	—	1.230	1.230	



AHU connection kit 16.0 to 56.0 kW for ECOi and ECO G

Models	PAW-	5 HP	10 HP	20 HP	30 HP	40 HP	50 HP	60 HP	
		160MAH2/M/L	280MAH2/M/L	560MAH2/M/L	280MAH2/M/L 560MAH2/M/L	560MAH2/M/L 560MAH2/M/L	560MAH2/M/L 560MAH2/M/L	560MAH2/M/L 560MAH2/M/L	
Cooling capacity	kW	14.0	28.0	56.0	84.0	112.0	140.0	168.0	
Heating capacity	kW	16.0	31.5	63.0	95.0	127.0	155.0	189.0	
Air flow	Cool Min/Max	m³/sec	0.72/0.32	1.39/0.97	2.78/1.95	4.17/2.92	5.56/3.89	6.94/4.86	8.33/5.83
Bypass factor recommended			0.9	0.9	0.9	0.9	0.9	0.9	
Dimensions	H x W x D	mm	278 x 278 x 180	278 x 278 x 180	278 x 278 x 180	278 x 278 x 180	278 x 278 x 180	278 x 278 x 180	
Net weight		kg	3.2	6.3	6.3	6.3	6.3	6.3	
Pipe length range		m	10~100	10~100	10~100	10~100	10~100	10~100	
Elevation difference (in / out)	Max	m	10	10	10	10	10	10	
Piping diameter	Liquid pipe	Inch (mm)	3/8(9.52)	3/8(9.52)	5/8(15.88)	3/4(19.05)	3/4(19.05)	3/4(19.05)	3/4(19.05)
	Gas pipe	Inch (mm)	5/8(15.88)	7/8(22.22)	1 1/8(28.58)	1 1/4(31.75)	1 1/2(38.15)	1 1/2(38.15)	1 1/2(38.15)
Intake temperature of AHU connection kit	Cool Min~Max	°C DB	+18~+32	+18~+32	+18~+32	+18~+32	+18~+32	+18~+32	+18~+32
	Cool Min~Max	°C WB	+13~+23	+13~+23	+13~+23	+13~+23	+13~+23	+13~+23	+13~+23
	Heat Min~Max	°C	+16~+30	+16~+30	+16~+30	+16~+30	+16~+30	+16~+30	+16~+30
Ambient temperature of outdoor unit	Cool Min~Max	°C	-10~+43	-10~+43	-10~+43	-10~+43	-10~+43	-10~+43	-10~+43
	Heat Min~Max	°C	-20~+15	-20~+15	-20~+15	-20~+15	-20~+15	-20~+15	-20~+15
RRP Advanced	£	1.853	1.935	2.145	—	—	—	—	
RRP Medium	£	1.342	1.484	1.721	—	—	—	—	
RRP Light	£	1.504	1.642	1.831	—	—	—	—	

Energy recovery ventilation

Panasonic energy recovery ventilators help you with your comfort and energy-saving plan.



Panasonic energy recovery ventilators can reduce the outside air load because they efficiently recover the energy lost by ventilation during the energy recovery process

This results in energy-saving ventilation and lower running costs for air-conditioning and heating equipment. Furthermore, by designing our current models with a counter-flow heat-exchange element, we achieved products with slim body shapes and quiet operation, that create a comfortable and pleasant air-conditioned environment, whilst saving energy.

- Dramatic energy savings achieved through adoption of a high-efficiency counter-flow heat-exchange element
- Counter-flow heat exchange element used for reduced noise and slimmer, more compact body shape
- All maintenance can be performed through a single inspection aperture

Energy efficiency and ecology

Energy consumption is dramatically reduced by using a counter-flow heat-exchange element. Air conditioning load is reduced by approximately 20 %, resulting in significant energy savings.

Comparison of former and current elements

With the cross-flow element, air moves in a straight line across the element; with the counter-flow element, air flows through the element for a longer time (longer distance), so the heat-exchange effect remains unchanged even if the element is made thinner.

- Straight air supply / exhaust system used for easier installation

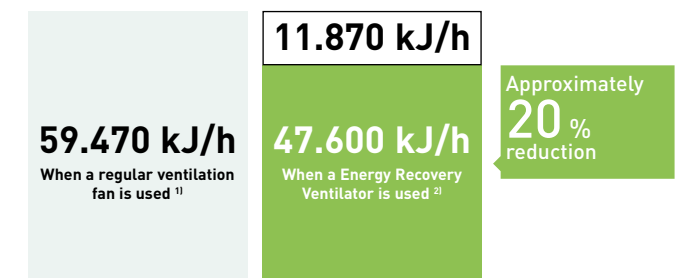

1) Two FY-27FPK7 units. 2) One FY-500ZDY8R unit.

More comfort

Quiet operation.

Low noise operation results in noticeably quieter units. All models with capacities below 0.14 m³/sec run at noise levels below 32 dB (high setting) and even our largest 0.28 m³/sec-capacity model runs at only 37.5 dB (high setting).

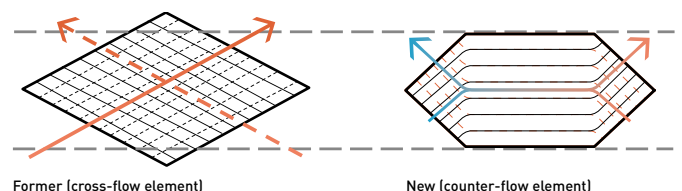



Rated flow rate		0.07 m³/sec			0.10 m³/sec			0.14 m³/sec			0.22 m³/sec			0.28 m³/sec					
Models		FY-250ZDY8R			FY-350ZDY8R			FY-500ZDY8R			FY-800ZDY8R			FY-01KZDY8R					
Power supply	Voltage	V																	
	Phase	Single phase																	
	Frequency	Hz																	
		50	50	50	50	50	50	50	50	50	50	50	50	50	50	50			
Notch		Extra high	High	Low	Extra high	High	Low	Extra high	High	Low	Extra high	High	Low	Extra high	High	Low			
Input power	W	112.0-128.0	108.0-123.0	87.0-96.0	182.0-190.0	178.0-185.0	175.0-168.0	263.0-289.0	204.0-225.0	165.0-185.0	387.0-418.0	360.0-378.0	293.0-295.0	437.0-464.0	416.0-432.0	301.0-311.0			
Air flow	m³/sec	0.07	0.07	0.05	0.10	0.10	0.07	0.14	0.14	0.12	0.22	0.22	0.18	0.28	0.28	0.19			
External static pressure	Pa	105	95	45	140	60	45	120	60	35	140	110	55	105	80	75			
Sound power	Heat exchange	dB(A)	30.0-31.5	29.5-30.5	23.5-26.5	32.5-33.0	30.5-31.0	22.5-25.5	36.5-37.5	34.5-35.5	31.0-32.5	37.0-37.5	36.5-37.0	33.5-34.5	37.5-38.5	37.0-37.5	33.5-34.5		
	Normal	dB(A)	30.0-31.5	29.5-30.5	23.5-26.5	32.5-33.0	30.5-31.0	22.5-25.5	37.5-38.5	37.0-38.0	31.0-32.5	37.0-37.5	36.5-37.0	33.5-34.5	39.5-40.5	39.0-39.5	35.5-36.5		
Temperature exchange efficiency	%	75	75	77	75	75	78	75	75	76	75	75	76	75	75	79			
Dimension	H x W x D	mm			270 x 882 x 599			317 x 1050 x 804			317 x 1090 x 904			388 x 1322 x 884			388 x 1322 x 1134		
Net weight	kg	29																	
		49																	
		57																	
		71																	
		83																	
RRP	£	1.167			1.528			1.846			2.440			2.716					

The noise level was measured within an acoustic chamber. Due to installation arrangement and surfaces within the space, actual noise levels may increase. The input, the current and the exchange efficiency are values relevant to the indicated air flows. The noise level is measured 1,5 m below the centre of the unit. The temperature exchange efficiency is an average of both cooling and heating operation.

Features

Energy efficiency and ecology.

- Up to 20 % energy saving in the installation
- Recovers up to 77 % of the heat in the outgoing air

Comfort.

- Cleaning reduced due to the revolutionary structure (every 6 months)
- Ideal for indoor spaces without windows

Easy installation and maintenance.

- 5 models for easier selection
- Reduced system height (270 mm, 317 mm and 388 mm)
- Side opening for cleaning (inspection of filter, motor and other parts)
- Installation can be reversed to share an inspection access between 2 machines
- Easy connection to the air conditioning unit
- Installation in false ceilings
- Units operate at 220 - 240 V
- High static pressure for easier installation

Technical focus

- High energy saving, up to 20 %
- Counter Cross Flow technology for better efficiency
- Long life element core
- Easy installation and 20 % less thickness
- Easy connection to air conditioning units
- Silent units

A intuitive and stylish control

- Wire controller included as standard
- Compact and flat front panel
- Filter cleaning support
 - Signal alert for clearing
 - Filter usage condition by 1/2/3/4 months
- Size (W x H x D) 116 x 120 x 40 mm



Electric air curtains

The Panasonic range of air curtains is designed for smooth operation and efficient performance. Air curtains produce a continuous stream of air blown from the top to the bottom of an open doorway and create a barrier that people and products can flow across, but air cannot.



Electric air curtain

1 Newly designed to maximize performance
High air flow upgraded 145 % compared to conventional model (in the case of FY-3009U1).

2 Comprehensive product line up
1.5 m wide model added in the line up.

3 Easier installation and maintenance
Simple structure for easy installation and maintenance.



Electric air curtain

			FY-3009U1	FY-3012U1	FY-3015U1
Width	mm		900	1200	1500
Voltage	V		220	220	220
Air flow	Hi / Lo	m ³ /sec	0.31/0.26	0.39/0.35	0.56/0.50
Consumption	Hi / Lo	W	76/70	94/85	131/110
Current	Hi / Lo	A	0.35/0.32	0.43/0.40	0.59/0.50
Air speed	Hi / Lo	m/s	10.50/8.50	9.50/8.00	10.50/9.50
Sound pressure		dB(A)	48.5/45.0	48.5/44.5	51.5/48.0
Dimension / Net weight	HxWxD	mm / kg	900x231.5x212/12.0	1200x231.5x212/14.5	1500x231.5x212/18.0
RRP		€	689	772	905

Electric air curtain with DX coil

Designed to improve energy efficiency, minimise heat loss from a building, and allow retailers to keep doors open to encourage customers, our air curtains are suitable for connection to both VRF and PACi Systems.



Highly efficient heating effect

The combined air stream, which has a desirable low air current induction factor (mixing factor), can carry the selected initial temperature effect over long distances, and will reach the floor area while still at room temperature. This is necessary to avoid cooling down the interior spaces.

Available in different lengths to suit requirements between 1 and 2.5 m, both air curtains have outlet grilles that can be adjusted to five different positions. The HS model can be installed up to a height of 3.0 m with the LS model up to 2.7 m. The outlet grilles can be easily adjusted into five positions to suit different installation requirements and the air filter can be accessed without the need for specialist tools.

- High performance with EC fan motor (40 % lower running costs compared to a standard AC fan motor)
- Easy Cleaning and Servicing
- Can be connected to either Panasonic VRF or PACi systems

Heating capacity comparison: Electrical air curtain / Panasonic air curtain.

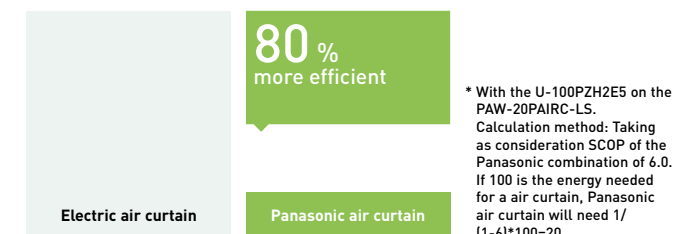

- Optional drain pump for cooling operation
- HS and LS models can be controlled via Panasonic's range of remote internet controls

The HS and LS models are ideal for connection to a ECOi or PACi system. With simple "plug and play" installation, both are fitted with an EC fan motor for a smooth operation and efficient performance. This fan guarantees 40 % lower running cost than with a standard AC fan motor. Air curtains run approximately 12 hours per day at shops, and efficient performance contributes to energy savings.

Optimised air flow velocity

1. Energy losses, no air curtain installed
2. Too low velocity air curtain – air curtain not efficient
3. Optimum results with the Frico air curtain connected to Panasonic VRF

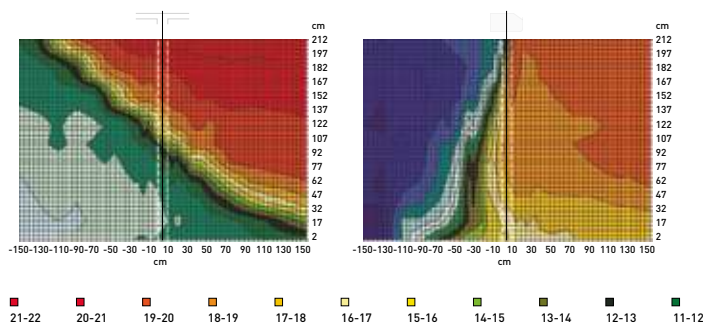

Opening without air curtain.

In an unprotected opening the cold air flows out and the cold storage room becomes much too warm.

Opening with air curtain, wrong angle.

If the angle is too small the hot air is blown into the cold storage room.

4. Too high velocity air curtain – considerable turbulence, energy lost to the outside, air curtain not efficient

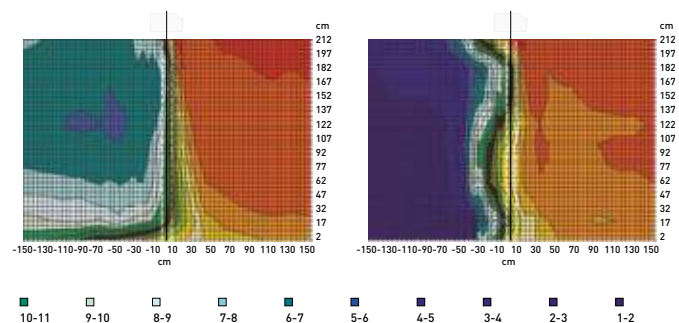

Opening with air curtain, too high speed.

Excessive speed creates turbulence, which causes energy loss and increases the cold storage temperature.

Opening with correctly adjusted air curtain.

With a correctly set air curtain unit there is a sharp separation between the different temperature zones.

Intelligent operation

Our air curtains combine air flow and heating / cooling technology to ensure optimum comfort and energy efficiency whilst also creating an effective barrier between indoor and outdoor environments. Design and installation is key to achieving the correct height / temperature settings to achieve optimum performance. Our air curtains are designed to answer the demands of the retail, commercial and industrial markets.

Heating mode.

Indoor temperature 20 °C.

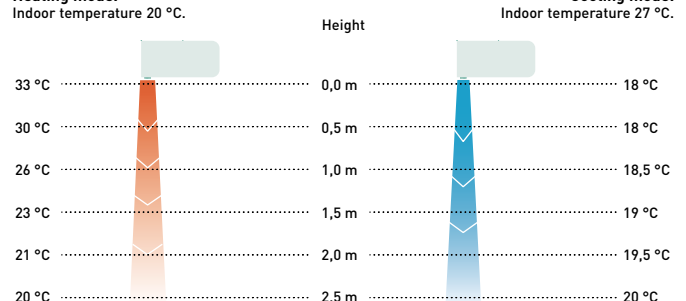

Air curtain with DX coil, connected to PACi systems

Comfort: Easy redirection of air flow by means of manual deflector.

Ease of use: Speed selector (high and low) on the unit itself.

Easy installation and maintenance: Easy installation / Compact dimensions improve installation and positioning / Easy cleaning of grid without opening of the unit.

* Arriving June 2022



Outdoor unit			7.1 kW	10.0 kW	14.0 kW	20.0 kW
Air outlet height 2.7 m			PAW-10PAIRC-LS-1	PAW-15PAIRC-LS-1	PAW-20PAIRC-LS-1	PAW-25PAIRC-LS-1
Cooling capacity ¹⁾	Max	kW	6.1	9.7	13.0	17.0
Heating capacity ²⁾	Max	kW	7.9	12.0	15.0	19.0
Air flow	High	m ³ /sec	0.50	0.75	1.00	1.25
Heat Exchanger	Volume	L	1.67	2.85	3.94	5.03
Electric consumption fan	230 V / 50 Hz	kW	0.30	0.50	0.60	0.80
Current	230 V / 50 Hz	A	2.10	3.10	4.10	5.10
Sound pressure ³⁾	Max	dB(A)	65	66	67	69
Air outlet height 3.0 m			PAW-10PAIRC-HS-1	PAW-15PAIRC-HS-1	PAW-20PAIRC-HS-1	PAW-25PAIRC-HS-1
Cooling capacity ¹⁾	Max	kW	9.1	13.0	19.5	23.7
Heating capacity ²⁾	Max	kW	11.8	15.8	23.6	27.6
Air flow	High	m ³ /sec	0.75	1.00	1.50	1.75
Heat Exchanger	Volume	L	1.67	2.85	3.94	5.12
Electric consumption fan	230 V / 50 Hz	kW	0.75	1.00	1.50	1.75
Current	230 V / 50 Hz	A	4.10	5.50	8.20	9.60
Sound pressure ³⁾	Max	dB(A)	66	67	68	68
Common data						
Dimension ⁴⁾	HxWxD	mm	260 (+140) x 1000 x 460	260 (+140) x 1500 x 460	260 (+140) x 2000 x 460	260 (+140) x 2500 x 460
Net weight	Air outlet height 2.7 m	kg	50	65	80	95
	Air outlet height 3.0 m	kg	55	65	85	110
Fan type			EC	EC	EC	EC
Piping diameter	Liquid pipe / Gas pipe	Inch (mm)	3/8 (9.52) / 5/8 (15.88)	3/8 (9.52) / 3/4 (19.05)	3/8 (9.52) / 7/8 (22.22)	3/8 (9.52) / 7/8 (22.22)
Door width		m	1.0	1.5	2.0	2.5
Refrigerant			R32	R32	R32	R32
RRP air outlet height 2.7 m		£	7.498	8.745	9.860	11.047
RRP air outlet height 3.0 m		£	7.814	8.995	10.296	11.276

1) Cooling capacity DX coil, air temperature in / out +27 / +18 °C, R32 and R410. 2) Heating capacity condenser, air temperature in / out +20 / +33 °C, R32 and R410. In the case of lower outdoor temperatures, an outdoor model with higher capacity may be necessary. 3) Measured in distance up to 5.0 m, direction factor 2, absorbing surfaces 200 m², Min / Max air flow. 4) 140 mm is the height of an electrical box if it is installed on the top.

Accessories		RRP £
PAW-AIR1-DP	Optional drain pump	506

Technical focus

- Now compatible with PACi NX Series
- Save up to 40 % energy costs by use of the integrated EC fan technology (higher efficiency than conventional AC fan, soft start and longer motor duration)
- 4 length of air curtain LS and HS are available 1.0, 1.5, 2.0 and 2.5 m
- Installation height up to 3.0 m
- Outlet grilles can be adjusted in five positions, to suite different indoor and installation requirements
- Control with Panasonic remote control systems (optional)
- Direct integration to BMS by optional Panasonic interfaces
- Drip tray included in all DX air curtain steps

How does it work?

Stale air from the room is taken in and ejected near the door. This creates a 'roll of air' that shields the door area, mixing with the colder incoming air. It then turns away from the door, back into the room and toward the intake screen, where it is partly drawn in again. This flow of air helps to create a barrier for heat loss yet at the same time refreshes room air

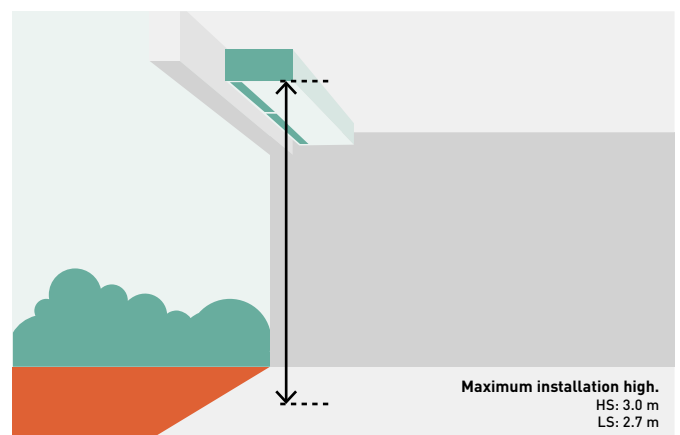



Air curtain with DX coil, connected to VRF systems

Comfort: Easy redirection of air flow by means of manual deflector.

Ease of use: Speed selector (high and low) on the unit itself.

Easy installation and maintenance: Easy installation / Compact dimensions improve installation and positioning / Easy cleaning of grid without opening of the unit.

Outdoor unit			4 HP	4 HP	5 HP	8 HP
Air outlet height 2.7 m			PAW-10EAIRC-LS	PAW-15EAIRC-LS	PAW-20EAIRC-LS	PAW-25EAIRC-LS
Cooling capacity ¹⁾	Max	kW	6.1	9.7	13.0	17.0
Heating capacity ²⁾	Max	kW	7.9	12.0	15.0	19.0
Air flow	High	m ³ /sec	0.50	0.75	1.00	1.25
Heat Exchanger	Volume	L	1.67	2.85	3.94	5.03
Electric consumption fan	230 V / 50 Hz	kW	0.30	0.50	0.60	0.80
Current	230 V / 50 Hz	A	2.10	3.10	4.10	5.10
Sound pressure ³⁾	Max	dB(A)	65	66	67	69
Air outlet height 3.0 m			PAW-10EAIRC-HS	PAW-15EAIRC-HS	PAW-20EAIRC-HS	PAW-25EAIRC-HS
Cooling capacity ¹⁾	Max	kW	9.1	13.0	19.5	23.7
Heating capacity ²⁾	Max	kW	11.8	15.8	23.6	27.6
Air flow	High	m ³ /sec	0.75	1.00	1.50	1.75
Heat Exchanger	Volume	L	1.67	2.85	3.94	5.12
Electric consumption fan	230 V / 50 Hz	kW	0.75	1.00	1.50	1.75
Current	230 V / 50 Hz	A	4.10	5.50	8.20	9.60
Sound pressure ³⁾	Max	dB(A)	66	67	68	68
Common data						
Dimension ⁴⁾	H x W x D	mm	260 (+140) x 1000 x 460	260 (+140) x 1500 x 460	260 (+140) x 2000 x 460	260 (+140) x 2500 x 460
Net weight	Air outlet height 2.7 m	kg	50	65	80	95
	Air outlet height 3.0 m	kg	55	65	85	110
Fan type			EC	EC	EC	EC
Piping diameter	Liquid pipe / Gas pipe	Inch (mm)	3/8(9.52) / 5/8(15.88)	3/8(9.52) / 3/4 (19.05)	3/8(9.52) / 7/8 (22.22)	3/8(9.52) / 7/8 (22.22)
Door width		m	1.0	1.5	2.0	2.5
Refrigerant			R32 / R410A	R32 / R410A	R32 / R410A	R32 / R410A
RRP air outlet height 2.7 m		£	8.103	9.571	10.769	12.050
RRP air outlet height 3.0 m		£	8.443	9.837	11.235	12.292

1) Cooling capacity DX coil, air temperature in / out +27 / +18 °C, R32 and R410. 2) Heating capacity condenser, air temperature in / out +20 / +33 °C, R32 and R410. In the case of lower outdoor temperatures, an outdoor model with higher capacity may be necessary. 3) Measured in distance up to 5.0 m, direction factor 2, absorbing surfaces 200 m², Min / Max air flow. 4) 140 mm is the height of an electrical box if it is installed on the top.

Accessories		RRP £
PAW-AIR1-DP	Optional drain pump	506

Technical focus

- Compatible with R32 and R410A refrigerant
- Save up to 40 % energy costs by use of the integrated EC fan technology (higher efficiency than conventional AC fan, soft start and longer motor duration)
- 4 length of air curtain LS and HS are available 1.0, 1.5, 2.0 and 2.5 m
- Installation height up to 3.0 m
- Outlet grilles can be adjusted in five positions, to suite different indoor and installation requirements
- Control with Panasonic remote control systems (optional)
- Direct integration to BMS by optional Panasonic interfaces
- Drip tray included in all DX air curtain steps

Internet control

An app added to your tablet or smartphone or via the Internet allows you to control and manage the system remotely. There is also the option to integrate into existing BMS systems by using other Panasonic interfaces.

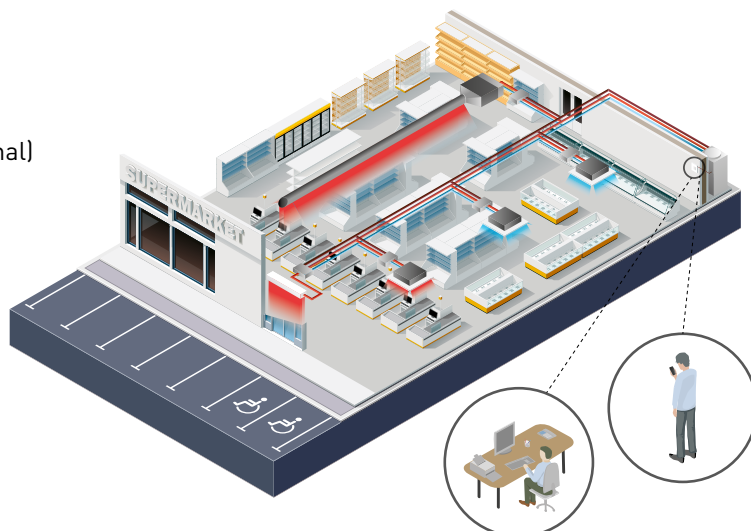



Control and connectivity

Panasonic has developed the largest range of control systems to offer the best option for commercial needs.

From the individual remote controller for the residential single units up to the newest technology capable of controlling your building anywhere in the world. The simple to use cloud software can even be used from a portable device.

Panasonic AC Smart Cloud	→ 166
Panasonic AC Service Cloud	→ 167
CONEX. Devices and apps	→ 168
Commercial Wi-Fi Adaptor	→ 169
Control and connectivity	→ 170

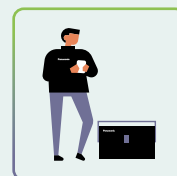
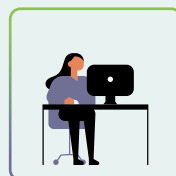
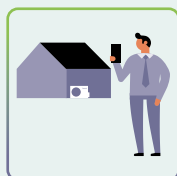
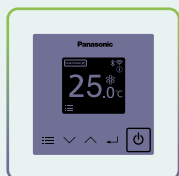

Panasonic AC Smart Cloud



Centralise control of your business premises, from wherever you are, 24/7/365.

The AC Smart Cloud system from Panasonic allows you to have complete control of all your installations from your tablet or from your computer. In a simple click, receive status updates, from all of your installations wherever the location, reducing potential breakdowns and optimising costs.



1 Comfort
Keep the comfort of workers, visitors and / or customers to increase satisfaction and productivity.

2 Return of investment
Optimising the operation of your heating and cooling system and the possibility to monitor remotely can expand the life of your assets.

3 Lower running cost
The control of settings in real time and the energy consumption monitor contributes to reduce your energy bill.

Flexible solution for your business



Every time



Everywhere



Multiplatform



Internet browser

1) Customized to meet user demand / Continuous upgrades: new functions and product introductions / IT smart management. 2) CZ-CAPRA1 is required.

Scalable solution for your business

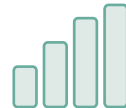

Small to large



1 to multi-sites



Upgrade features ¹⁾



RAC ²⁾ / PACi / ECOi / ECO G

Full multi-site and user control

Each location can allow access for multiple users whether in the same building or via remote access. The scalability allows addition of multiple sites and customise the access of your team and the access of your trusted service.

Key functions and uniqueness



Multi-site monitoring.
· It doesn't matter how many sites you have, easy to manage, operate, compare sites, locations, rooms



Powerful statistics for energy savings.
· Power consumption, capacity, efficiency level can be compared with different parameters (Yearly / monthly / weekly / daily basis)



Schedule setting.
· Setting yearly / weekly / holidays timers as you want



Maintenance notification.
· Error notification by email and with floor layout
· Maintenance notification of ECOi / ECO G outdoor units
· Remote service checker function

Panasonic AC Service Cloud

Panasonic AC Service Cloud provides maintenance companies a unique tool to deliver advanced service and maintenance features, decreasing response times, reduce sites visits and better allocate resources.



Owners can manage different maintenance companies for each site enabling or disabling access with just one click.
Maintenance companies can have access to all sites where different owners gave permissions.

1 Time response and zero down time
Providing remotely technical information about abnormalities and checker functions enable AC installer and maintainer to identify and fix issue much quicker even though before it occurs.

2 Reduce unnecessary trips
It reduces the cost of unnecessary trips, reducing the CO₂ emissions related to the transport.

3 Maintenance planning
With a simple click, easily identify the nature of potential issues, enabling issue classification, prioritising resources and better plan visits to site. Send the right engineer for the job.

4 All at a glance and scalability
Remotely view all sites requiring maintenance of Panasonic HVAC. Increase the number of sites maintained, taking advantage of future updates and features of the Panasonic AC Service Cloud

New system health check function

Self diagnosis function is ready in Panasonic AC Service Cloud. It automatically detects potential malfunction and helps speed up your service process.
- Consecutive automatic monitoring at 15 minute intervals

- Key notifications in the event potential malfunction is detected
- 2D graph display to help with detailed analysis
- Threshold values can be easily adjusted

* For compatible models, please contact an authorized Panasonic dealer.

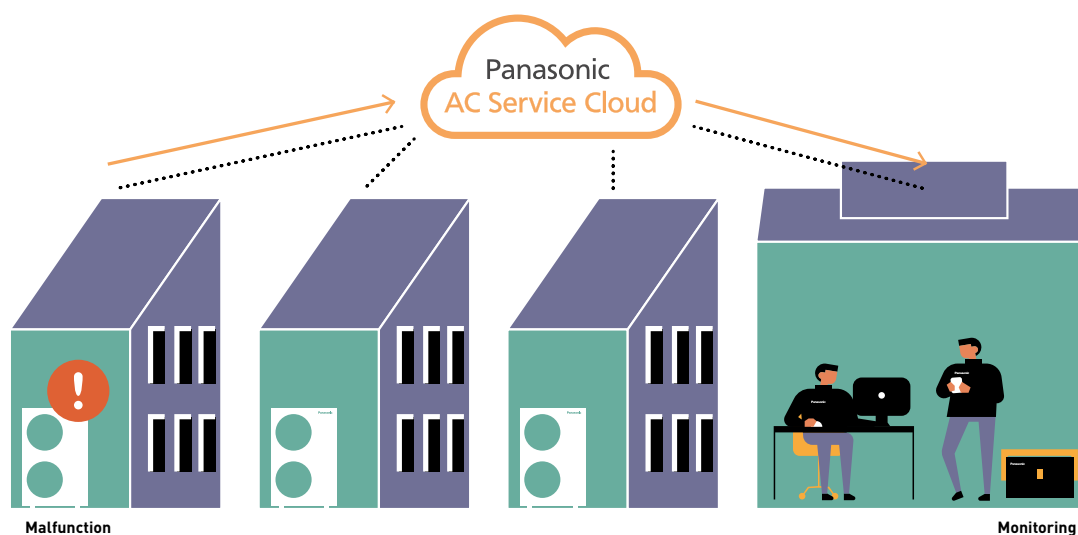

CONEX. Devices and apps

CONEX provides comfort and control for varying user needs. Accessible, flexible and scalable with different controllers and apps. Perfectly meeting requirements of modern controls for end user, installer and service. With nanoe™ X function, technology with the benefits of hydroxyl radicals.



1 Intuitive control with stylish design

- Simple operation at a glance
- Clean face with full flat and black LCD display
- Compact body, only 86x86 mm

2 Control comfort with your smartphone

- Flexible control options with IoT integration
- Panasonic H&C Control App for daily remote control operation
- Panasonic Comfort Cloud App for remote operation 24/7/365

3 Easy maintenance with service support app

- Quick and easy app set-up for system setting
- Panasonic H&C Diagnosis App enables the user to obtain detailed system operation data

* The use of apps depends on the remote controller model.

CONEX with IoT integration



The wired remote controller series is fully integrated with IoT solutions developed by Panasonic. Detailed operation, maintenance setting and service operation are all possible with smartphone or tablet.

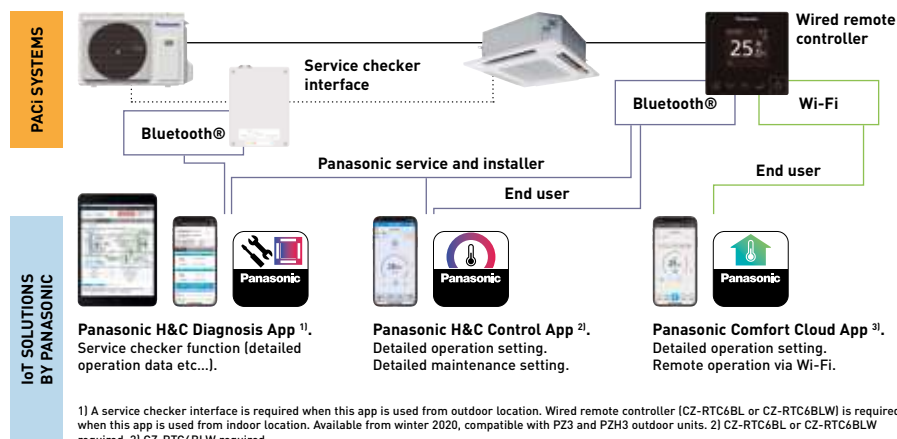

Model	CZ-RTC6	CZ-RTC6BL	CZ-RTC6BLW
Wired connection compatible with	PACi, PACi NX, ECOi, GHP	PACi, PACi NX, ECOi, GHP	PACi NX only
Wireless functions	No wireless capability	Bluetooth®	Bluetooth® + Wi-Fi
App compatibility			
Panasonic Comfort Cloud App	—	—	✓
Panasonic H&C Control App	—	✓ PACi, PACi NX, ECOi, GHP	✓ PACi NX only
Panasonic H&C Diagnosis App ¹⁾	—	✓ PACi NX only ²⁾	✓ PACi NX only ²⁾
Outdoor unit settings (remote controller connected to indoor unit)	✓ PACi NX only ²⁾	✓ PACi NX only ²⁾	✓ PACi NX only ²⁾

1) Compatible with U-71/100/125/140PZH3E5/8 and U-100/125/140PZ3E5/8. 2) When connected to PACi NX indoor and outdoor unit combination.

Commercial Wi-Fi Adaptor

Panasonic CZ-CAPWFC1 interface adaptor, allows connection of one or a group of indoor units to Panasonic Comfort Cloud App, which provides control, monitoring, scheduling and error alerts.

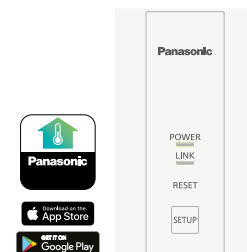

Advanced smartphone control

Control PACi, ECOi and ECO G indoor units with your smartphone from wherever and whenever you are, by using Panasonic Comfort Cloud App and Commercial Wi-Fi Adaptor. This scalable solution is ideal for one system, one site or multiple locations. Coupling the adapter with the already feature rich systems, makes it an ideal solution for residential and commercial applications.

1 From 1 to 200 units
User can control up to 10 different sites, with up to 20 units / groups per site. Additionally, one adaptor can be connected to 1 indoor or to a group of up to 8 indoors.

2 Voice control compatible
Registering the unit to Panasonic Comfort Cloud App it makes it compatible with the most popular voice assistants.

3 Multi user
The Panasonic Comfort Cloud App allows multi-user access control, whilst allowing user restriction to specific units.

4 Easy scheduling
Complex weekly scheduling made simple. Not only for one unit, but across multiple sites and from a smartphone.

5 Energy monitor
See the estimated power consumption and compare with other periods, to see how energy consumption can be further reduced. Check list of units that provides consumption*.

6 Error codes
Error code notification through the App, provides early notification and allows for faster repair.

* Function available depending on the model.

Connection Diagram

Commercial Wi-Fi Adaptor wiring length is 1.9 m and connects to indoor unit thru T10 connector and R1/R2 terminal connectors.

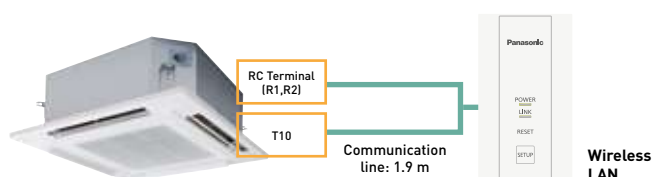

Input Voltage	DC 12 V (supplied from T10 connector)
Power Consumption	Maximum 2.4 W
Size (HxWxD)	120 x 70 x 25 mm
Weight	190 g (including communications lines)
Interface	1 x Wireless LAN
Wireless LAN Standard	IEEE 802.11 b/g/n
Frequency Range	2.4 GHz band
Operating range	0 ~ 55 °C, 20 ~ 80 RH%
Connectable indoor unit	1 unit
Length of communication line	1.9 m (included in the shipment)

Download free app: Panasonic Comfort Cloud App.

Other hardware requirements: Router and Internet (purchase and subscribe separately).

Panasonic Cloud Server is designed, operated and managed by Panasonic.



Control and connectivity

A wide variety of control options to meet the requirements of different applications.

Centralized control systems

<p>Centralised control.</p>  <p>P-AIMS core software. Up to 1024 indoor units. CZ-CSWK2</p>	<p>Intelligent controller.</p>  <p>Intelligent controller. Up to 256 indoor units touch screen with web server. CZ-256ESMC3</p>	<p>Panasonic AC Smart Cloud.</p>  <p>Cloud internet control. Up to 128 groups. Controls 128 units. CZ-CFUSCC1</p>
--	--	--

Connection with general equipment.

 <p>ON / OFF control for external devices such as ERV. Controls 1 unit. CZ-CAPC3</p>	 <p>Mini Seri-Para I/O Unit 0 - 10 V. Controls 1 indoor unit or a group of 8 indoor units. CZ-CAPBC2</p>	 <p>Communication Adaptor. Up to 128 groups. Controls 128 units. CZ-CFUNC2</p>
---	---	---

Domestic integration to P-Link - CZ-CAPRA1

Can connect RAC range to P-Link. Full control is now possible.

Integrates any unit in big system control.

- YKEA server room integration ¹⁾
- Small offices with domestic indoors
- Tender for refurbishment (old system Domestic and VRF in one installation)

¹⁾ When duty rotation using the remote controller is set up, CZ-CAPRA1 cannot be connected.

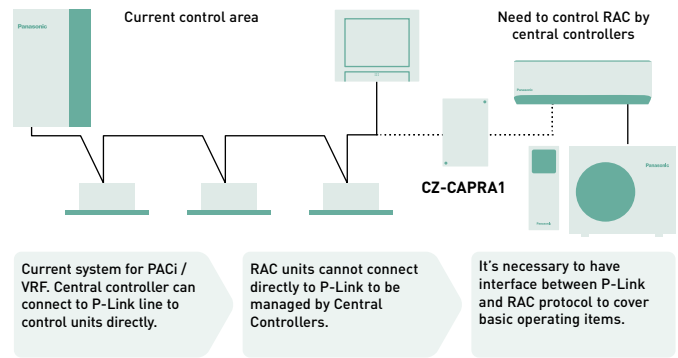

<p>Centralized Control Systems: 64 indoor units</p> 	<p>Intelligent controller / Web Server: 256 indoor units</p> 	<p>Panasonic AC Smart Cloud</p> 
---	---	--

Basic operation items: ON / OFF, Mode select, Temperature setting, Fan speed, Flap setting, Remote control prohibit.

External input: ON / OFF control signal, Abnormal stop signal.

External output for Relay ¹⁾: Operation status (ON / OFF), Alarm status output.





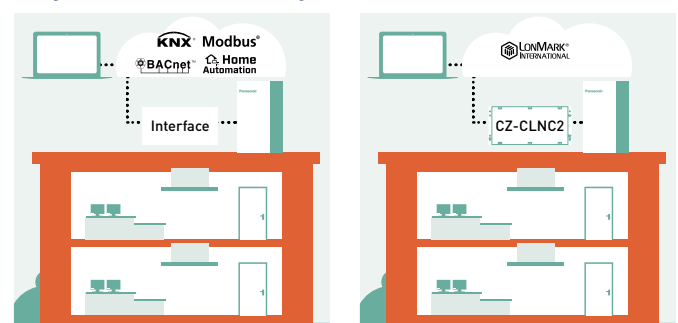

¹⁾ Because current CN-CNT connector can not provide the power for external output relay, additional Input power for external relay is necessary.

Easy connection to KNX, Modbus, Lonworks, BACnet and Proprietary Home Automation Systems

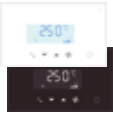
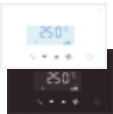
Easy and reliable solution to integrate your Panasonic heating and cooling systems into any B.M.S or E.M.S. Fully bi-directional communications with all necessary parameters.

For more information, contact Panasonic.



			Econavi control	Built-in thermostat	Indoor units which can be controlled	Use limitations	Function ON / OFF	Mode setting	Fan speed setting	Temperature setting	Air flow direction	Permit/Prohibit switching	Weekly program	BMS protocol
Individual controllers														
Touch room controller for hotel with Dry Contacts		PAW-RE2C4-MOD-WH PAW-RE2C4-MOD-BK WH: White, BK: Black. Bespoke finish available on request.	—	✓	1 indoor unit	—	✓	✓	✓	✓	—	✓	—	Modbus + 4 digital I/O signals
Touch display control for hotel with Dry Contacts		PAW-RE2D4-WH PAW-RE2D4-BK WH: White, BK: Black. Bespoke finish available on request.	—	✓	1 indoor unit	—	✓	✓	✓	✓	—	✓	—	Stand Alone + 2 digital inputs
Design wired remote controller		CZ-RTC5B	✓	✓	1 group, 8 units	· Up to 2 controllers can be connected per group	✓	✓	✓	✓	✓	—	✓	—
Wired remote controller		CZ-RTC6 Non-wireless	✓	✓	1 group, 8 units	· Up to 2 controllers can be connected per group	✓	✓	✓	✓	✓	—	—	—
		CZ-RTC6BL With Bluetooth®	✓	✓	1 group, 8 units	· Up to 1 controller can be connected per group	✓	✓	✓	✓	✓	—	✓	—
		CZ-RTC6BLW With Wi-Fi and Bluetooth®	✓	✓	1 group, 8 units	· Up to 1 controller can be connected per group	✓	✓	✓	✓	✓	—	✓	—
Infrared remote controller		CZ-RWS3 + CZ-RWRU3W CZ-RWS3 + CZ-RWRY3 CZ-RWS3 CZ-RWS3 + CZ-RWRL3 CZ-RWS3 + CZ-RWRD3 CZ-RWS3 + CZ-RWRT3 CZ-RWS3 + CZ-RWRC3	✓	—	1 group, 8 units	· Up to 2 controllers can be connected per group	✓	✓	✓	✓	✓ ¹⁾	—	—	—
Centralized controllers														
System controller with weekly timer		CZ-64ESMC3	✓	—	64 groups, maximum 64 units	· Up to 10 controllers, can be connected to one system · Main unit/sub unit (1 main unit + 1 sub unit) connection is possible · Use without remote controller is possible	✓	✓	✓	✓	✓ ¹⁾	✓	✓	—
Central ON / OFF controller		CZ-ANC3	—	—	16 groups, maximum 64 units	· Up to 8 controllers (4 main units + 4 sub units) can be connected to one system · Use without remote controller is impossible	✓	—	—	—	—	✓	—	—
Intelligent controller (touch screen / web server)		CZ-256ESMC3	✓	—	Main unit: 128. Up to 256 units can be expanded	· Communication adaptor CZ-CFUNC2 is necessary for connection with more than 128 units	✓	✓	✓	✓	✓ ¹⁾	✓	✓	—

1. Setting is not possible when a remote controller unit is present (use the remote controller for setting). * All specifications subject to change without notice.

ECO i - W



Discover a new era of ECOi, the ECOi-W. Heat pumps and cooling only chillers

Panasonic introduces the ECOi-W heat pumps and cooling only chiller series.

These series provides a wide variety of HVAC system solutions, to meet all of your residential, commercial and industrial needs.

ECOi-W the solution for hotels, offices and industry	→ 174	Fan coils	→ 194
Range of ECOi-W outdoor units	→ 176	Range of fan coils	→ 196
ECOi-W heat pump outdoor units	→ 178	Fan coils - ducted	→ 198
U - 020/025/030/035/040 CW	→ 180	Fan coils - high static pressure ducted	→ 200
U - 045/055/065/075 CW	→ 181	Fan coils - 4 way cassette	→ 202
U - 090/105/125 CW	→ 182	Fan coils - ceiling chassis	→ 204
U - 140/150/170/190/210 CW	→ 183	Fan coils - floor-standing chassis	→ 206
Options for heat pump outdoor units	→ 184	Fan coils - wall-mounted	→ 208
ECOi-W cooling only outdoor units	→ 186	Smart fan coils	→ 209
U - 020/025/030/035/040 CV	→ 188	Simple user friendly control for outdoor units	→ 210
U - 045/055/065/075 CV	→ 189	Wired controllers for AC and EC fan coils	→ 211
U - 090/105/125 CV	→ 190	Accessories and control	→ 212
U - 140/150/170/190/210 CV	→ 191		
Options for cooling only outdoor units	→ 192		

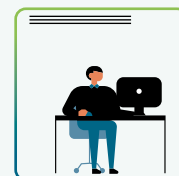
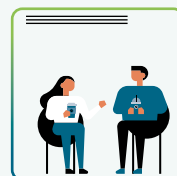
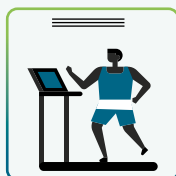
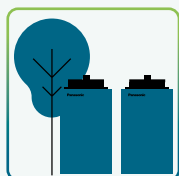

ECOi-W the solution for hotels, offices and industry

ECO *i* - W

Unrivalled Reliability and Quality.

Panasonic solutions can be enjoyed for years to come, even in the most extreme climates. Panasonic does not compromise on product quality, safety or durability, in order to provide the ultimate comfort when you need it most.



- 1 High energy saving and comfort**
- High SEER / SCOP
 - Quiet operation
 - Integration with ECOi VRF systems via BMS control
 - **NEW!** Centralized remote management system

- 2 High flexibility**
- Capacity range from 20 to 210 kW
 - Customisable design
 - Operating range: -17 °C (heating) to 50 °C (cooling)
 - Wide range of hydraulic options
 - Wide range of communication protocols

- 3 High quality**
- Defrost limiting coil design (140 to 210 kW)
 - Optimised design for service and maintenance
 - Compact footprint

Operating conditions

Panasonic ECOi-W provides a wide operating range from -17 °C in heating to 50 °C in cooling.

Water outlet temperature in cooling: A uniqueness of ECOi-W, is the water outlet temperature down to -10 °C in cooling. It can ensure the operation temperature of the process equipment in factories.

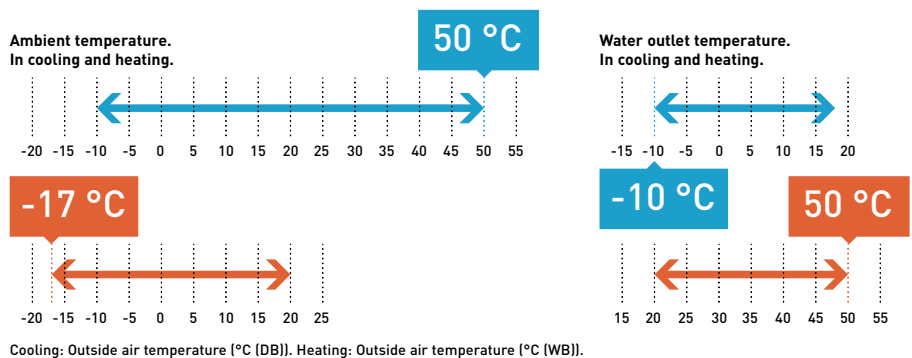

ECOi-W the solution for hotels, offices and industry



Hotels.



Offices.



Industry.

ECOi-W line-up

ECOi-W size	20	25	30	35	40	45	55	65	75	90	105	125	140	150	170	190	210	
Heat pump range																		
SEER ¹⁾	4.68	4.31	4.28	4.25	4.33	4.20	4.41	4.51	4.63	4.40	4.44	4.49	4.39	4.36	4.31	4.23	4.28	
SCOP ¹⁾	3.50	3.38	3.45	3.50	3.50	3.38	3.38	3.55	3.53	3.40	3.43	3.43	3.30	3.33	3.30	3.28	3.23	
Energy efficiency class (heating) ^{1) 2)}	A+	A+	A+	A+	A+	A+	A+	A+	—	—	—	—	—	—	—	—	—	
Cooling only range																		
	SEER	4.78	4.38	4.43	4.43	4.48	4.40	4.53	4.53	4.68	4.45	4.50	4.55	4.40	4.45	4.38	4.40	4.25
Dimensions (HxWxD)	 1983x1000x1000			 1983x1000x1000		 1986x2180x1160		 1986x2180x1160		 2286x2180x1160			 2295x2856x2210		 2321x2856x2210			

1) Those are the data with variable flow. 2) Following Eurovent and COMMISSION REGULATION (EU) No 811/2013 for low-temperature heat pumps. Scale from A+++ to D, as of 26th September 2019.

Panasonic offers its customers cutting-edge technology, specially designed to ensure our systems deliver even higher performance.



Simple user friendly control.

A control panel with intuitive design is equipped on all ECOi-W systems as standard. The microprocessor based control has a IHM logic and implements a smart handling for your demand.



PAW-SYSREMKIT

Remote control kit (optional). Simple remote control for the need to be installed remotely from the units.



PAW-CM000SP041

NEW remote monitoring service ECOi-W Cloud (optional). It allows users to access necessary parameters remotely in real time to optimise the daily service and maintenance work.

Please check page 210 for detailed information.

Range of ECOi-W outdoor units

Page	Outdoor units	20 kW	25 kW	30 kW	35 kW	40 kW	45 kW	55 kW	65 kW	75 kW
------	---------------	-------	-------	-------	-------	-------	-------	-------	-------	-------

ECOi-W 20 to 40



P. 180	Heat pump	U-020CWNB U-020CWBS	U-025CWNB U-025CWBS	U-030CWNB U-030CWBS	U-035CWNB U-035CWBS	U-040CWNB U-040CWBS
P. 188	Cooling only	U-020CVNB U-020CVBS	U-025CVNB U-025CVBS	U-030CVNB U-030CVBS	U-035CVNB U-035CVBS	U-040CVNB U-040CVBS

ECOi-W 45 to 75



P. 181	Heat pump				U-045CWNB U-045CWBM	U-055CWNB U-055CWBM	U-065CWNB U-065CWBM	U-075CWNB U-075CWBM
P. 189	Cooling only				U-045CVNB U-045CVBM	U-055CVNB U-055CVBM	U-065CVNB U-065CVBM	U-075CVNB U-075CVBM

ECOi-W 90 to 125

P. 182 Heat pump

P. 190 Cooling only

ECOi-W 140 to 210

P. 183 Heat pump

P. 191 Cooling only

90 kW

105 kW

125 kW

140 kW

150 kW

170 kW

190 kW

210 kW



U-090CWNB
U-090CWBM

U-105CWNB
U-105CWBM

U-125CWNB
U-125CWBM

U-090CVNB
U-090CVBM

U-105CVNB
U-105CVBM

U-125CVNB
U-125CVBM



U-140CWNB
U-140CWBL

U-150CWNB
U-150CWBL

U-170CWNB
U-170CWBL

U-190CWNB
U-190CWBL

U-210CWNB
U-210CWBL

U-140CVNB
U-140CVBL

U-150CVNB
U-150CVBL

U-170CVNB
U-170CVBL

U-190CVNB
U-190CVBL

U-210CVNB
U-210CVBL



Features of ECOi-W heat pump outdoor units

ECOi-W heat pump outdoor units.

- High seasonal efficiency in cooling and heating
- Eurovent certified
- Ambient temperature operating range: -10 to +50 °C in cooling, -17 to +20 °C in heating
- Water outlet temperature range: -10 to +18 °C in cooling, +20 to +50 °C ¹⁾ in heating
- Optimised design for service and maintenance
- Simple user friendly control as standard
- Modbus RTU as standard

Technical focus:

- Chiller type: heat pump
- Refrigerant type: R410A
- Heat exchanger: stainless steel plate heat exchanger
- Flow switch, water safety and air purge valves included
- Water filter included (mandatory to be installed on site)
- Night mode setting to save energy and reduce noise level
- Water compensation curve control
- Bluefin anti-corrosion coating
- Optional hydraulic kit
- Optional finned coil treatment

U - 020/025/030/035/040 CW

- Super quiet operation

Technical focus:

- Compressor type (number of compressors): Scroll compressors (2)
- Refrigerant circuit: 1

- Fan type (number of fans): axial fan (1)
- Optional Desuperheater for free hot water up to 50 °C*
- Optional Modbus TCP / IP, BACnet IP and BACnet MSTP
- Optional remote LAN connection

* Available on special order only, please contact your local Panasonic sales representative.

U - 045/055/065/075 CW

- Optional extra-low noise kit available

Technical focus:

- Compressor type (number of compressors): Scroll compressors (2)

- Refrigerant circuit: 1
- Fan type (number of fans): axial fan (1 for 45/55, 2 for 65/75)
- Optional Desuperheater for free hot water up to 50 °C
- Optional Modbus TCP / IP, BACnet IP and BACnet MSTP
- Optional remote LAN connection

U - 090/105/125 CW

- Optional extra-low noise kit available

Technical focus:

- Compressor type (number of compressors): Scroll compressors (2)

- Refrigerant circuit: 1
- Fan type (number of fans): axial fan (2)
- Optional Desuperheater for free hot water up to 50 °C
- Optional Modbus TCP / IP, BACnet IP and BACnet MSTP
- Optional remote LAN connection

U - 140/150/170/190/210 CW

- Smart defrost:
Defrost limiting design to ensure a constant water outlet temperature even at very low temperatures

1 DEFROST CYCLE EVERY 130 MINUTES.	Heating Capacity: +22 % Integrated COP: +15 % Improved SCOP Class
---------------------------------------	---

Technical focus:

- Compressor type (number of compressors): Scroll compressors (4)
- Refrigerant circuit: 2
- Fan type (number of fans): axial fan (4)
- Optional gauges hydraulic and refrigerant
- Optional BACnet
- Remote LAN connection as standard

- Super quiet operation
- Victaulic water connections
- Modbus TCP / IP as standard

SEE MORE OPTIONS FOR HEAT PUMP OUTDOOR UNITS

Available options for U - 020/025/030/035/040 CW

Options				
Pump	Pump drive	Hydraulic options	Ambient options	Miscellaneous options
Single pump	Variable twin speed ¹⁾	Low water pressure sensor	Finned coil treatment - epoxy	Soft starter
	Variable capacity	Water isolation valves	Rubber pads	Power supply w/o neutral
	Constant outlet pressure		Spring damper	Modbus TCP/IP
	Constant differential pressure		All seasons	BACnet MSTP
			Nordic pack	BACnet IP
			High pressure fan ²⁾	Remote LAN connection
				Desuperheater ³⁾

1) Available as standard on models 20 - 40 when pump is selected. 2) Available on models 25 - 40. 3) Available on special order only, please contact your local Panasonic sales representative.

Available options for U - 045/055/065/075 CW

Options				
Pump	Pump drive	Hydraulic options	Ambient options	Miscellaneous options
Single pump	Fixed speed	Low water pressure sensor	Finned coil treatment - epoxy	Soft starter
Double pump	Variable twin speed	Water isolation valves	Outdoor coil protection grid	Power supply w/o neutral
	Variable capacity	Electrical heater low power (only with buffer tank)	Rubber pads	Modbus TCP/IP
	Constant outlet pressure		Spring damper	BACnet MSTP
	Constant differential pressure	Electrical heater high power (only with buffer tank)	All seasons fan control	BACnet IP
			Extra-low noise kit	Remote LAN connection
			High pressure fan	Container transport
				Refrigerant gauge
				Desuperheater

Available options for U - 090/105/125 CW

Options				
Pump	Pump drive	Hydraulic options	Ambient options	Miscellaneous options
Single pump	Fixed speed	Low water pressure sensor	Finned coil treatment - epoxy	Soft starter
Double pump	Variable twin speed	Water isolation valves	Outdoor coil protection grid	Power supply w/o neutral
	Variable capacity	Electrical heater low power (only with buffer tank)	Rubber pads	Modbus TCP/IP
	Constant outlet pressure		Spring damper	BACnet MSTP
	Constant differential pressure	Electrical heater high power (only with buffer tank)	All seasons fan control	BACnet IP
			Extra-low noise kit	Remote LAN connection
			High pressure fan	Container transport
				Refrigerant gauge
				Desuperheater

Available options for U - 140/150/170/190/210 CW

Options				
Pump	Pump drive	Hydraulic options	Ambient options	Miscellaneous options
Single pump low pressure	Fixed speed	Low water pressure sensor	Finned coil treatment - epoxy	Soft starter
Single pump high pressure	Variable twin speed	Water isolation valves	Outdoor coil protection grid	Power supply w/o neutral
Double pump low pressure	Variable capacity	Hydraulic gauges	Rubber pads	Modbus TCP/IP
Double pump high pressure	Constant outlet pressure		Spring damper	BACnet IP
	Constant differential pressure		All seasons fan control	Container transport
			Nordic pack	Refrigerant gauge
			High pressure fan	



U - 020/025/030/035/040 CW

Cooling capacity: 19.4 to 37.4 kW

Heating capacity: 19.5 to 41.6 kW

Compact and powerful heat pump chiller series with Panasonic quality verification.

ECOi-W Series guarantees quiet operation.

Please contact Panasonic for RRP.



Model		20	25	30	35	40	
Standard without buffer tank		U-020CWNB	U-025CWNB	U-030CWNB	U-035CWNB	U-040CWNB	
With buffer tank		U-020CWBS	U-025CWBS	U-030CWBS	U-035CWBS	U-040CWBS	
Power supply	Voltage	V	400	400	400	400	400
	Phase		Three phase	Three phase	Three phase	Three phase	Three phase
	Frequency	Hz	50	50	50	50	50
Cooling capacity ¹⁾	kW	18.7	23.7	26.4	35.8	38.1	
Input power ¹⁾	kW	5.9	7.7	9.4	12.3	13.1	
Total EER 100 % ¹⁾		3.15	3.07	2.81	2.92	2.91	
SEER ^{2) 3)}		4.68	4.31	4.28	4.25	4.33	
$\eta_{s,c}$ ^{2) 3)}	%	184	169	168	167	170	
Heating capacity ⁴⁾	kW	19.5	26.9	29.7	37.3	41.6	
Input power ⁴⁾	kW	6.1	9.3	9.9	13.2	13.5	
SCOP ^{5) 6)}		3.50	3.38	3.45	3.50	3.50	
$\eta_{s,h}$ ^{5) 6)}	%	137	132	135	137	137	
Energy efficiency class (Scale A+++ to D) ⁶⁾		A+	A+	A+	A+	A+	
Startup type		Direct	Direct	Direct	Direct	Direct	
Maximum operating current	A	17.7	22.2	24.3	31.8	33.8	
Startup current w/o softstarter / w softstarter	A	53/20	64/35	77/41	118/53	119/54	
Sound power (w standard fans)	dB(A)	75.0	75.0	75.0	76.0	76.0	
Sound pressure (w standard fans) ⁷⁾	dB(A)	42.8	42.8	42.8	43.8	43.8	
Dimension (w standard fans) w/o buffer tank	HxWxD	mm	1983x1000x1000	1983x1000x1000	1983x1000x1000	1983x1000x1000	
Dimension (w standard fans) w buffer tank	HxWxD	mm	1983x1000x1507	1983x1000x1507	1983x1000x1507	1983x1000x1507	
Weight (w 1 pump) w/o buffer tank	kg	280	290	320	330	335	
Weight (w 1 pump) w buffer tank	kg	345	355	385	395	400	
Refrigerant (R410A)	kg	8.4	8.4	8.4	9.1	9.2	
Number of refrigerant circuit		1	1	1	1	1	
Compressors							
Number		2	2	2	2	2	
Type		Scroll	Scroll	Scroll	Scroll	Scroll	
Part load step	%	0/50/100	0/50/100	0/50/100	0/50/100	0/50/100	
Crankcase heater	W	2x40	2x40	2x49	2x49	2x49	
Evaporator							
Number		1	1	1	1	1	
Type		Plate	Plate	Plate	Plate	Plate	
Nominal water flow (cooling)	m ³ /h	3.35	4.36	4.64	6.16	6.44	
Water pressure drop (cooling)	kPa	23	37	22	37	40	
Water volume	l	1.78	1.78	2.55	2.55	2.55	
Antifreeze heater	W	30	30	30	30	30	
Coils							
Number		1	1	1	1	1	
Frontal surface	m ²	2.4	2.4	2.4	2.8	2.8	
Number of rows		2	2	2	2	2	
Fans standard							
Number		1	1	1	1	1	
Air flow	m ³ /sec	2.50	3.61	3.61	4.44	4.44	
Rotation speed	r.p.m.	900	900	900	650	650	
Power input (each fan)	W	620	940	940	930	930	
Water connections							
Type		Male gas threaded	Male gas threaded	Male gas threaded	Male gas threaded	Male gas threaded	
		BSP ISO 228	BSP ISO 228	BSP ISO 228	BSP ISO 228	BSP ISO 228	
Inlet - diameter	Inch	1 1/2	1 1/2	1 1/2	1 1/2	1 1/2	
Outlet - diameter	Inch	1 1/2	1 1/2	1 1/2	1 1/2	1 1/2	

1) Data refers to 7 °C leaving chilled water temperature and 35 °C condenser air temperature, according EN14511 standard. 2) Following COMMISSION REGULATION (EU) No 2016/2281 for comfort application chillers. 3) Those are the data with variable flow. 4) Data refers to 45 °C leaving warm water temperature and 7 °C ambient coil air temperature with 87 % R.H., according EN14511 standard. 5) Following COMMISSION REGULATION (EU) No 813/2013 for low-temperature heat pumps. 6) Following Eurovent and COMMISSION REGULATION (EU) No 811/2013 for low-temperature heat pumps. Scale from A+++ to D, as of 26th September 2019. 7) Sound pressure levels calculated at 10 meters. Sound pressure levels refer to ISO standard 3744 with parallel piped shape. * w: with, w/o: without.

Accessories

PAW-SYSREMKIT	Remote control
PAW-CM000SP041	Cloudgate plug and play IP65 box mobile 4G Europe
PAW-CM000K0001	Extension kit and cable gland for mobile (2/4G) antenna (3 m)

Accessories

PAW-00SRTS011	Tservice wireless fee for 1 year
PAW-SYSSOV1	Shut off valves kit for model 20 - 40



**U - 045/055/065/075 CW****Cooling capacity: 46.8 to 71.6 kW****Heating capacity: 48.5 to 75.9 kW**

High seasonal efficiency in cooling, maximum SEER 4.63 in this range. ECOi-W Series offers a variety of options to meet your needs.

Please contact Panasonic for RRP.



Model			45	55	65	75
Standard without buffer tank			U-045CWNB	U-055CWNB	U-065CWNB	U-075CWNB
With buffer tank			U-045CWBM	U-055CWBM	U-065CWBM	U-075CWBM
Power supply	Voltage	V	400	400	400	400
	Phase		Three phase	Three phase	Three phase	Three phase
	Frequency	Hz	50	50	50	50
Cooling capacity ¹⁾		kW	44.3	50.9	64.1	71.0
Input power ¹⁾		kW	15.9	18.0	21.8	24.0
Total EER 100 % ¹⁾			2.78	2.83	2.95	2.96
SEER ^{2) 3)}			4.20	4.41	4.51	4.63
$\eta_{s,c}$ ^{2) 3)}		%	165	174	177	182
Heating capacity ⁴⁾		kW	48.5	58.2	67.2	75.9
Input power ⁴⁾		kW	17.3	20.4	22.5	24.3
SCOP ^{3) 5)}			3.38	3.38	3.55	3.53
$\eta_{s,h}$ ^{3) 5)}		%	132	132	139	138
Energy efficiency class (Scale A+++ to D) ⁶⁾			A+	A+	A+	—
Startup type			Direct	Direct	Direct	Direct
Maximum operating current		A	40.2	44.2	59.4	64.4
Startup current w/o softstarter / w softstarter		A	133/66	140/73	201/101	206/106
Sound power (w standard fans)		dB(A)	80.0	80.0	80.0	80.0
Sound pressure (w standard fans) ⁷⁾		dB(A)	47.8	47.8	47.8	47.8
Dimension (w standard fans) w/o buffer tank	H x W x D	mm	1986 x 2180 x 1160	1986 x 2180 x 1160	1986 x 2180 x 1160	1986 x 2180 x 1160
Dimension (w standard fans) w buffer tank	H x W x D	mm	1986 x 2680 x 1160	1986 x 2680 x 1160	1986 x 2680 x 1160	1986 x 2680 x 1160
Weight (w 1 pump) w/o buffer tank		kg	540	550	610	620
Weight (w 1 pump) w buffer tank		kg	700	710	770	780
Refrigerant (R410A)		kg	14.5	14.9	18.9	19.0
Number of refrigerant circuit			1	1	1	1
Compressors						
Number			2	2	2	2
Type			Scroll	Scroll	Scroll	Scroll
Part load step		%	0/50/100	0/43/57/100	0/40/60/100	0/45/55/100
Crankcase heater		W	2x66	2x66	2x66	2x66
Evaporator						
Number			1	1	1	1
Type			Plate	Plate	Plate	Plate
Nominal water flow (cooling)		m ³ /h	8.06	9.18	11.30	12.31
Water pressure drop (cooling)		kPa	30	35	28	37
Water volume		l	4.10	4.10	6.10	6.10
Antifreeze heater		W	30	30	2x30	2x30
Coils						
Number			1	1	2	2
Frontal surface		m ²	4.20	4.20	5.55	5.55
Number of rows			2	2	2	2
Fans standard						
Number			1	1	2	2
Air flow		m ³ /sec	6.25	6.25	8.33	8.33
Rotation speed		r.p.m.	790	790	650	650
Power input (each fan)		W	1650	1650	930	930
Water connections						
Type			Male gas threaded BSPP ISO 228	Male gas threaded BSPP ISO 228	Male gas threaded BSPP ISO 228	Male gas threaded BSPP ISO 228
Inlet - diameter		Inch	2	2	2	2
Outlet - diameter		Inch	2	2	2	2

1) Data refers to 7 °C leaving chilled water temperature and 35 °C condenser air temperature, according EN14511 standard. 2) Following COMMISSION REGULATION (EU) No 2016/2281 for comfort application chillers. 3) Those are the data with variable flow. 4) Data refers to 45 °C leaving warm water temperature and 7 °C ambient coil air temperature with 87 % R.H., according EN14511 standard. 5) Following COMMISSION REGULATION (EU) No 813/2013 for low-temperature heat pumps. 6) Following Eurovent and COMMISSION REGULATION (EU) No 811/2013 for low-temperature heat pumps. Scale from A+++ to D, as of 26th September 2019. 7) Sound pressure levels calculated at 10 meters. Sound pressure levels refer to ISO standard 3744 with parallel piped shape. * w: with, w/o: without.

Accessories

PAW-SYSREMKIT	Remote control
PAW-CM000SP041	Cloudgate plug and play IP65 box mobile 4G Europe
PAW-CM000K0001	Extension kit and cable gland for mobile (2/4G) antenna (3 m)

Accessories

PAW-00SRTS011	Tservice wireless fee for 1 year
PAW-SYSSOV2	Shut off valves kit for model 45 - 75





U - 090/105/125 CW

Cooling capacity: 91.4 to 121.9 kW
Heating capacity: 88.1 to 119.1 kW

Customizable design gives high flexibility. Wide range of communication protocols fulfill the requirements in hotels, offices, industry applications.

Please contact Panasonic for RRP.



Model			90	105	125
Standard without buffer tank			U-090CWNB	U-105CWNB	U-125CWNB
With buffer tank			U-090CWBM	U-105CWBM	U-125CWBM
Power supply	Voltage	V	400	400	400
	Phase		Three phase	Three phase	Three phase
	Frequency	Hz	50	50	50
Cooling capacity ¹⁾		kW	88.7	100.8	119.3
Input power ¹⁾		kW	30.6	34.8	40.4
Total EER 100 % ¹⁾			2.90	2.89	2.96
SEER ^{2) 3)}			4.40	4.44	4.49
$\eta_{s,c}$ ^{2) 3)}		%	173	175	177
Heating capacity ⁴⁾		kW	88.1	101.0	119.1
Input power ⁴⁾		kW	33.8	38.4	45.5
SCOP ^{3) 5)}			3.40	3.43	3.43
$\eta_{s,h}$ ^{3) 5)}		%	133	134	134
Startup type			Direct	Direct	Direct
Maximum operating current		A	77.9	86.0	102.0
Startup current w/o softstarter / w softstarter		A	265 / 127	312 / 146	345 / 183
Sound power (w standard fans)		dB(A)	83.0	83.0	83.0
Sound pressure (w standard fans) ⁶⁾		dB(A)	50.8	50.8	50.8
Dimension (w standard fans) w/o buffer tank	H x W x D	mm	2286 x 2180 x 1160	2286 x 2180 x 1160	2286 x 2180 x 1160
Dimension (w standard fans) w buffer tank	H x W x D	mm	2286 x 2680 x 1160	2286 x 2680 x 1160	2286 x 2680 x 1160
Weight (w 1 pump) w/o buffer tank		kg	790	900	920
Weight (w 1 pump) w buffer tank		kg	950	1060	1080
Refrigerant (R410A)		kg	22.0	27.0	28.5
Number of refrigerant circuit			1	1	1
Compressors					
Number			2	2	2
Type			Scroll	Scroll	Scroll
Part load step		%	0/45/55/100	0/38/62/100	0/33/67/100
Crankcase heater		W	66/82	66/95	66/95
Evaporator					
Number			1	1	1
Type			Plate	Plate	Plate
Nominal water flow (cooling)		m ³ /h	15.73	18.25	20.95
Water pressure drop (cooling)		kPa	26	34	45
Water volume		l	10.80	10.80	10.80
Antifreeze heater		W	2x30	2x30	2x30
Coils					
Number			2	2	2
Frontal surface		m ²	6.4	6.4	6.4
Number of rows			2	3	3
Fans standard					
Number			2	2	2
Air flow		m ³ /sec	11.67	11.67	11.67
Rotation speed		r.p.m.	790	790	790
Power input (each fan)		W	1650	1650	1650
Water connections					
Type			Male gas threaded BSPP ISO 228	Male gas threaded BSPP ISO 228	Male gas threaded BSPP ISO 228
Inlet - diameter		Inch	2 1/2	2 1/2	2 1/2
Outlet - diameter		Inch	2 1/2	2 1/2	2 1/2

1) Data refers to 7 °C leaving chilled water temperature and 35 °C condenser air temperature, according EN14511 standard. 2) Following COMMISSION REGULATION (EU) No 2016/2281 for comfort application chillers. 3) Those are the data with variable flow. 4) Data refers to 45 °C leaving warm water temperature and 7 °C ambient coil air temperature with 87 % R.H., according EN14511 standard. 5) Following COMMISSION REGULATION (EU) No 813/2013 for low-temperature heat pumps. 6) Sound pressure levels calculated at 10 meters. Sound pressure levels refer to ISO standard 3744 with parallel piped shape. * w: with, w/o: without.

Accessories	
PAW-SYSREMKIT	Remote control
PAW-CM000SP041	Cloudgate plug and play IP65 box mobile 4G Europe
PAW-CM000K001	Extension kit and cable gland for mobile (2/4G) antenna (3 m)

Accessories	
PAW-00SRTS011	Tservice wireless fee for 1 year
PAW-SYSSOV3	Shut off valves kit for model 90 - 125



**U - 140/150/170/190/210 CW****Cooling capacity: 125.4 to 195.4 kW****Heating capacity: 143.7 to 217.6 kW**

Heat pump chiller series with powerful operation by 4 scroll compressors. Maximum water outlet temperature in heating is up to 50 °C ¹⁾. Defrost limiting design ensures to provide stable hot water even at low ambient conditions.

Please contact Panasonic for RRP.



Model		140	150	170	190	210
Standard without buffer tank		U-140CWNB	U-150CWNB	U-170CWNB	U-190CWNB	U-210CWNB
With buffer tank		U-140CWBL	U-150CWBL	U-170CWBL	U-190CWBL	U-210CWBL
Power supply	Voltage	V	400	400	400	400
	Phase		Three phase	Three phase	Three phase	Three phase
	Frequency	Hz	50	50	50	50
Cooling capacity ¹⁾	kW	128.3	142.1	163.9	177.5	207.9
Input power ¹⁾	kW	43.2	47.7	54.7	61.3	69.7
Total EER 100 % ¹⁾		2.97	2.98	2.99	2.90	2.98
SEER ^{2) 3)}		4.39	4.36	4.31	4.23	4.28
$\eta_{s,c}$ ^{2) 3)}	%	173	171	169	166	168
Heating capacity ⁴⁾	kW	144.0	154.0	170.0	195.0	218.0
Input power ⁴⁾	kW	45.7	50.3	55.5	67.4	78.3
SCOP ^{3) 5)}		3.30	3.33	3.30	3.23	3.23
$\eta_{s,h}$ ^{3) 5)}	%	129	130	129	128	126
Startup type		Direct	Direct	Direct	Direct	Direct
Maximum operating current	A	108.0	119.0	136.0	153.0	170.0
Startup current w/o softstarter / w softstarter	A	251/130	262/141	324/161	341/178	396/201
Sound power (w standard fans)	dB(A)	85.4	85.4	87.0	88.1	88.1
Sound pressure (w standard fans) ⁶⁾	dB(A)	53.4	53.4	55.0	56.1	56.1
Dimension (w standard fans) w/o buffer tank	HxWxD	mm	2295x2856x2210	2295x2856x2210	2295x2856x2210	2295x2856x2210
Dimension (w standard fans) w buffer tank	HxWxD	mm	2295x3666x2210	2295x3666x2210	2295x3666x2210	2295x3666x2210
Weight (w 1 low Pa pump) w/o buffer tank	kg	1570	1580	1680	1750	2020
Weight (w 1 low Pa pump) w buffer tank	kg	1700	1710	1810	1880	2150
Refrigerant (R410A)	kg	2 x 24.7	2 x 24.7	24.7/33.3	2 x 33.3	2 x 33.3
Number of refrigerant circuit		2	2	2	2	2
Compressors						
Number		4	4	4	4	4
Type		Scroll	Scroll	Scroll	Scroll	Scroll
Part load step	%	0 / 24 / 26 / 48 / 50 / 52 / 74 / 76 / 100	0 / 23 / 27 / 46 / 50 / 54 / 73 / 77 / 100	0 / 20 / 24 / 44 / 45 / 55 / 69 / 80 / 100	0 / 22 / 28 / 44 / 50 / 56 / 72 / 78 / 100	0 / 19 / 31 / 38 / 50 / 62 / 69 / 81 / 100
Crankcase heater	W	4x66	4x66	3x66/82	2x82/2x66	2x95/2x66
Evaporator						
Number		1	1	1	1	1
Type		Plate	Plate	Plate	Plate	Plate
Nominal water flow (cooling)	m ³ /h	21.56	23.65	25.95	30.24	33.62
Water pressure drop (cooling)	kPa	33	39	24	32	40
Water volume	l	8.49	8.49	12.21	12.21	12.21
Antifreeze heater	W	60	60	120	120	120
Coils						
Number		4	4	4	4	4
Frontal surface	m ²	11.88	11.88	11.88	11.88	11.88
Number of rows		2+2	2+2	2+3	3+3	3+3
Fans standard						
Number		4	4	4	4	4
Air flow	m ³ /sec	15.56	15.56	19.72	23.89	23.06
Rotation speed	r.p.m.	900	900	900	900	900
Power input (each fan)	W	940	940	940 - 1650	1650	1650
Water connections						
Type		Victaulic	Victaulic	Victaulic	Victaulic	Victaulic
Inlet - diameter	Inch	2 1/2	2 1/2	2 1/2	2 1/2	2 1/2
Outlet - diameter	Inch	2 1/2	2 1/2	2 1/2	2 1/2	2 1/2

1) Data refers to 7 °C leaving chilled water temperature and 35 °C condenser air temperature, according EN14511 standard. 2) Following COMMISSION REGULATION (EU) No 2016/2281 for comfort application chillers. 3) Those are the data with variable flow. 4) Data refers to 45 °C leaving warm water temperature and 7 °C ambient coil air temperature with 87 % R.H., according EN14511 standard. 5) Following COMMISSION REGULATION (EU) No 813/2013 for low-temperature heat pumps. 6) Sound pressure levels calculated at 10 meters. Sound pressure levels refer to ISO standard 3744 with parallel piped shape. * w: with, w/o: without.

Accessories

PAW-SYSREMKIT	Remote control
PAW-CM000SP041	Cloudgate plug and play IP65 box mobile 4G Europe
PAW-CM000K0001	Extension kit and cable gland for mobile (2/4G) antenna (3 m)

Accessories

PAW-00SRTS011	Tservice wireless fee for 1 year
PAW-SYSVICTH	Victaulic connection kit for model 140 - 210





Options for heat pump outdoor units

Options table 20 - 125

Option	Type	Ref.	Description	Model													
				20	25	30	35	40	45	55	65	75	90	105	125		
1	Capacity																
2	Refrigerant and compressor type	W	R410A, fixed speed, heat pump	•	•	•	•	•	•	•	•	•	•	•	•	•	
		NB	No buffer	Std	Std	Std	Std	Std	Std	Std	Std	Std	Std	Std	Std	Std	Std
		BS	Buffer tank (small)	•	•	•	•	•									
3	Buffer tank option	BM	Buffer tank (medium)						•	•	•	•	•	•	•	•	
			No pump	Std	Std	Std	Std	Std	Std	Std	Std	Std	Std	Std	Std	Std	Std
			Single pump	•	•	•	•	•	•	•	•	•	•	•	•	•	•
4	Pump option		Double pump						•	•	•	•	•	•	•	•	
			Pump drive - fixed speed						Std	Std	Std	Std	Std	Std	Std	Std	
			Pump drive - variable twin speed (single pump)	•	•	•	•	•	•	•	•	•	•	•	•	•	•
			Pump drive - variable twin speed (double pump)						•	•	•	•	•	•	•	•	•
			Pump drive - variable speed capacity (single pump)	•	•	•	•	•	•	•	•	•	•	•	•	•	•
			Pump drive - variable speed capacity (double pump)						•	•	•	•	•	•	•	•	•
			Pump drive - constant outlet pressure (single pump)	•	•	•	•	•	•	•	•	•	•	•	•	•	•
			Pump drive - constant outlet pressure (double pump)						•	•	•	•	•	•	•	•	•
			Pump drive - constant differential pressure (single pump) ¹⁾	S0	S0	S0	S0	S0	S0	S0	S0	S0	S0	S0	S0	S0	S0
5	Pump drive option		No hydraulic options	Std	Std	Std	Std	Std	Std	Std	Std	Std	Std	Std	Std	Std	
			Low water pressure sensor ²⁾	•	•	•	•	•	•	•	•	•	•	•	•	•	
			Water isolation valves	•	•	•	•	•	•	•	•	•	•	•	•	•	
			Electric heater - low power (buffer tank required)						•	•	•	•	•	•	•	•	
			Electric heater - high power (buffer tank required)						•	•	•	•	•	•	•	•	
6	Hydraulic options		No ambient options	Std	Std	Std	Std	Std	Std	Std	Std	Std	Std	Std	Std	Std	
			Finned coil treatment - epoxy	•	•	•	•	•	•	•	•	•	•	•	•	•	
			Outdoor coil protection grid	•	•	•	•	•	•	•	•	•	•	•	•	•	
			Rubber pads	•	•	•	•	•	•	•	•	•	•	•	•	•	
			Spring damper	•	•	•	•	•	•	•	•	•	•	•	•	•	
			Fan speed control (FSC)	•	•	•	•	•	•	•	•	•	•	•	•	•	
			Nordic pack ³⁾	•	•	•	•	•									
			Low noise	Std	Std	Std	Std	Std	•	•	•	•	•	•	•	•	
			High pressure fan ⁴⁾	S0	•	•	•	•	•	•	•	•	•	•	•	•	
7	Ambient options		No miscellaneous options	Std	Std	Std	Std	Std	Std	Std	Std	Std	Std	Std	Std	Std	
			Soft starter	•	•	•	•	•	•	•	•	•	•	•	•	•	
			Power supply w/o neutral ⁵⁾	S0	S0	S0	S0	S0	S0	S0	S0	S0	S0	S0	S0	S0	
			Standard BMS option (Modbus RTU)	Std	Std	Std	Std	Std	Std	Std	Std	Std	Std	Std	Std	Std	
			Modbus TCP/IP	•	•	•	•	•	•	•	•	•	•	•	•	•	
			BACnet MSTP	•	•	•	•	•	•	•	•	•	•	•	•	•	
			BACnet IP	•	•	•	•	•	•	•	•	•	•	•	•	•	
			Remote LAN connection	•	•	•	•	•	•	•	•	•	•	•	•	•	
			Container transport						•	•	•	•	•	•	•	•	
			Refrigerant gauge						•	•	•	•	•	•	•	•	
			Desuperheater ⁶⁾	•	•	•	•	•	•	•	•	•	•	•	•	•	
		8	Miscellaneous options														

1) Constant differential pump drive options are only available on a special order and requires additional production time. Please contact your local sales representative.

2) Supplied loose for unit w/o pump.

3) The Nordic pack is not required on models 45 - 125 due to model design.

4) High pressure fan is not available on model 20 due to body design.

5) Power supply without Neutral is only available on a special order basis, and requires additional production time. Please contact your local sales representative.

6) Inclusion of desuperheater will extend standard production time, please contact your local Panasonic sales representative for details.

Std: Standard item included.

•: Optional item that can be selected.

S0: Special order item.



Options table 140 - 210

Option	Type	Ref.	Description	Model				
				140	150	170	190	210
1	Capacity							
2	Refrigerant and compressor type	W	R410A, fixed speed, heat pump	•	•	•	•	•
3	Buffer tank option	NB	No buffer	Std	Std	Std	Std	Std
		BL	Buffer tank (large)	•	•	•	•	•
4	Pump option		No pump	Std	Std	Std	Std	Std
			Single pump low pressure	•	•	•	•	•
			Single pump high pressure	•	•	•	•	•
			Double pump low pressure	•	•	•	•	•
			Double pump high pressure	•	•	•	•	•
			Pump drive - fixed speed ¹⁾	Std	Std	Std	Std	Std
5	Pump drive option		Pump drive - variable twin speed (single pump)	•	•	•	•	•
			Pump drive - variable twin speed (double pump)	•	•	•	•	•
			Pump drive - variable speed capacity (single pump)	•	•	•	•	•
			Pump drive - variable speed capacity (double pump)	•	•	•	•	•
			Pump drive - constant outlet pressure (single pump)	•	•	•	•	•
			Pump drive - constant outlet pressure (double pump)	•	•	•	•	•
6	Hydraulic options		Pump drive - constant differential pressure (single pump) ²⁾	S0	S0	S0	S0	S0
			Pump drive - constant differential pressure (double pump) ²⁾	S0	S0	S0	S0	S0
			No hydraulic options	Std	Std	Std	Std	Std
			Low water pressure sensor ³⁾	•	•	•	•	•
			Water isolation valves	•	•	•	•	•
			Hydraulic gauges	•	•	•	•	•
7	Ambient options		No ambient options	Std	Std	Std	Std	Std
			Finned coil treatment - epoxy	•	•	•	•	•
			Outdoor coil protection grid ⁴⁾	•	•	•	•	•
			Rubber pads	•	•	•	•	•
			Spring damper	•	•	•	•	•
			Fan speed control (FSC)	•	•	•	•	•
8	Miscellaneous options		Nordic pack	•	•	•	•	•
			Low noise	Std	Std	Std	Std	Std
			No miscellaneous options	Std	Std	Std	Std	Std
			Soft starter	•	•	•	•	•
			Power supply w/o neutral	•	•	•	•	•
			Standard BMS option (Modbus RTU)	Std	Std	Std	Std	Std
	Modbus TCP/IP	•	•	•	•	•		
	BACnet IP	•	•	•	•	•		
	Remote LAN connection	Std	Std	Std	Std	Std		
	Container transport	•	•	•	•	•		
	Refrigerant gauge	•	•	•	•	•		

1) Fixed speed pump drive is standard when selecting a pump. Please select an alternative pump drive if required.

2) Constant differential pump drive options are only available on a special order and requires additional production time. Please contact your local sales representative.

3) Supplied loose for unit w/o pump.

4) Not available when using Nordic pack.

Std: Standard item included.

•: Optional item that can be selected.

S0: Special order item.



Features of ECOi-W cooling only outdoor units

ECOi-W cooling only outdoor units.

- High seasonal efficiency
- Ambient temperature operating range: -10 to +50 °C
- Water outlet temperature range: -10 to +18 °C
- Optimised design for service and maintenance
- Simple user friendly control as standard
- Modbus RTU as standard

Technical focus:

- Chiller type: cooling only
- Refrigerant type: R410A
- Heat exchanger: stainless steel plate heat exchanger
- Flow switch, water safety and air purge valves included
- Water filter included (mandatory to be installed on site)
- Night mode setting to save energy and reduce noise level
- Water compensation curve control
- Optional hydraulic kit
- Optional finned coil treatment

U - 020/025/030/035/040 CV

- Super quiet operation

Technical focus:

- Compressor type (number of compressors): Scroll compressors (2)
- Refrigerant circuit: 1

- Fan type (number of fans): axial fan (1)
- Optional Desuperheater for free hot water up to 50 °C*
- Optional Modbus TCP / IP, BACnet IP and BACnet MSTP
- Optional remote LAN connection

* Available on special order only, please contact your local Panasonic sales representative.

U - 045/055/065/075 CV

- Optional extra-low noise kit available

Technical focus:

- Compressor type (number of compressors): Scroll compressors (2)

- Refrigerant circuit: 1
- Fan type (number of fans): axial fan (1 for 45/55, 2 for 65/75)
- Optional Desuperheater for free hot water up to 50 °C
- Optional Modbus TCP / IP, BACnet IP and BACnet MSTP
- Optional remote LAN connection

U - 090/105/125 CV

- Optional extra-low noise kit available

Technical focus:

- Compressor type (number of compressors): Scroll compressors (2)

- Refrigerant circuit: 1
- Fan type (number of fans): axial fan (2)
- Optional Desuperheater for free hot water up to 50 °C
- Optional Modbus TCP / IP, BACnet IP and BACnet MSTP
- Optional remote LAN connection

U - 140/150/170/190/210 CV

- Super quiet operation
- Victaulic water connections
- Modbus TCP / IP as standard

Technical focus:

- Compressor type (number of compressors): Scroll compressors (4)

- Refrigerant circuit: 2
- Fan type (number of fans): axial fan (4)
- Optional gauges hydraulic and refrigerant
- Optional BACnet
- Remote LAN connection as standard

SEE MORE OPTIONS FOR
COOLING ONLY OUTDOOR UNITS**Available options for U - 020/025/030/035/040 CV**

Options				
Pump	Pump drive	Hydraulic options	Ambient options	Miscellaneous options
Single pump (as standard)	Fixed speed ¹⁾	Low water pressure sensor	Finned coil treatment - epoxy	Soft starter
	Variable twin speed	Water isolation valves	Rubber pads	Power supply w/o neutral
	Variable capacity		Spring damper	Modbus TCP/IP
	Constant outlet pressure		All seasons	BACnet MSTP
Constant differential pressure		High pressure fan ²⁾	BACnet IP	
				Remote LAN connection
				Desuperheater ³⁾

1) Available for non-EU installation. 2) Available on models 25 - 40. 3) Available on special order only, please contact your local Panasonic sales representative.

Available options for U - 045/055/065/075 CV

Options				
Pump	Pump drive	Hydraulic options	Ambient options	Miscellaneous options
Single pump	Fixed speed ¹⁾	Low water pressure sensor	Finned coil treatment - epoxy	Soft starter
Double pump	Variable twin speed	Water isolation valves	Outdoor coil protection grid	Power supply w/o neutral
	Variable capacity		Rubber pads	Modbus TCP/IP
	Constant outlet pressure		Spring damper	BACnet MSTP
	Constant differential pressure		All seasons fan control	BACnet IP
			Extra-low noise kit	Remote LAN connection
			High pressure fan	Container transport
				Refrigerant gauge
				Desuperheater

1) Available for non-EU installation.

Available options for U - 090/105/125 CV

Options				
Pump	Pump drive	Hydraulic options	Ambient options	Miscellaneous options
Single pump	Fixed speed ¹⁾	Low water pressure sensor	Finned coil treatment - epoxy	Soft starter
Double pump	Variable twin speed	Water isolation valves	Outdoor coil protection grid	Power supply w/o neutral
	Variable capacity		Rubber pads	Modbus TCP/IP
	Constant outlet pressure		Spring damper	BACnet MSTP
	Constant differential pressure		All seasons fan control	BACnet IP
			Extra-low noise kit	Remote LAN connection
			High pressure fan	Container transport
				Refrigerant gauge
				Desuperheater

1) Available for non-EU installation.

Available options for U - 140/150/170/190/210 CV

Options				
Pump	Pump drive	Hydraulic options	Ambient options	Miscellaneous options
Single pump Low Pressure	Fixed speed ¹⁾	Low water pressure sensor	Finned coil treatment - epoxy	Soft starter
Single pump High Pressure	Variable twin speed	Water isolation valves	Outdoor coil protection grid	Power supply w/o neutral
Double pump Low Pressure	Variable capacity	Hydraulic gauges	Rubber pads	Modbus TCP/IP
Double pump High Pressure	Constant outlet pressure			Spring damper
	Constant differential pressure		All seasons fan control	Container transport
			High pressure fan ²⁾	Refrigerant gauge

1) Available for non-EU installation. 2) Available on special order only, please contact your local Panasonic sales representative



U - 020/025/030/035/040 CV

Cooling capacity: 19.3 to 40.9 kW

Compact and highly efficient chiller series, with SEER up to 4.78.

Please contact Panasonic for RRP.



Model		20	25	30	35	40	
Standard without buffer tank		U-020CVNB	U-025CVNB	U-030CVNB	U-035CVNB	U-040CVNB	
With buffer tank		U-020CVBS	U-025CVBS	U-030CVBS	U-035CVBS	U-040CVBS	
Power supply	Voltage	V	400	400	400	400	400
	Phase		Three phase	Three phase	Three phase	Three phase	Three phase
	Frequency	Hz	50	50	50	50	50
Cooling capacity ¹⁾	kW	19.2	24.3	27.1	36.7	39.0	
Input power ¹⁾	kW	5.9	7.7	9.3	12.2	13.0	
Total EER 100 % ¹⁾		3.25	3.17	2.90	3.01	3.00	
SEER ²⁾		4.78	4.38	4.43	4.43	4.48	
$\eta_{s,c}$ ²⁾	%	188	172	174	174	176	
Startup type		Direct	Direct	Direct	Direct	Direct	
Maximum operating current	A	17.7	22.2	24.3	31.8	33.8	
Startup current w/o softstarter / w softstarter	A	53/28	64/35	77/49	118/53	119/54	
Sound power (w standard fans)	dB(A)	75.0	75.0	75.0	76.0	76.0	
Sound pressure (w standard fans) ³⁾	dB(A)	42,8	42,8	42,8	43,8	43,8	
Dimension (w standard fans) w/o buffer tank	H x W x D	mm	1983 x 1000 x 1000	1983 x 1000 x 1000	1983 x 1000 x 1000	1983 x 1000 x 1000	
Dimension (w standard fans) w buffer tank	H x W x D	mm	1983 x 1000 x 1507	1983 x 1000 x 1507	1983 x 1000 x 1507	1983 x 1000 x 1507	
Weight (w 1 pump) w/o buffer tank	kg	265	275	305	315	320	
Weight (w 1 pump) w buffer tank	kg	330	340	370	380	385	
Refrigerant (R410A)	kg	6.5	8.4	8.4	9.1	9.2	
Number of refrigerant circuit		1	1	1	1	1	
Compressors							
Number		2	2	2	2	2	
Type		Scroll	Scroll	Scroll	Scroll	Scroll	
Part load step	%	0/50/100	0/50/100	0/50/100	0/50/100	0/50/100	
Crankcase heater	W	2x40	2x40	2x49	2x49	2x49	
Evaporator							
Number		1	1	1	1	1	
Type		Plate	Plate	Plate	Plate	Plate	
Nominal water flow (cooling)	m ³ /h	3.35	4.36	4.64	6.16	6.44	
Water pressure drop (cooling)	kPa	23	37	22	37	40	
Water volume	l	1.78	1.78	2.55	2.55	2.55	
Antifreeze heater	W	30	30	30	30	30	
Coils							
Number		1	1	1	1	1	
Frontal surface	m ²	2.4	2.4	2.4	2.8	2.8	
Number of rows		2	2	2	2	2	
Fans standard							
Number		1	1	1	1	1	
Air flow	m ³ /sec	2.50	3.61	3.61	4.44	4.44	
Rotation speed	r.p.m.	900	900	900	650	650	
Power input (each fan)	W	620	940	940	930	930	
Water connections							
Type		Male gas threaded BSPP ISO 228	Male gas threaded BSPP ISO 228	Male gas threaded BSPP ISO 228	Male gas threaded BSPP ISO 228	Male gas threaded BSPP ISO 228	
Inlet - diameter	Inch	1 1/2	1 1/2	1 1/2	1 1/2	1 1/2	
Outlet - diameter	Inch	1 1/2	1 1/2	1 1/2	1 1/2	1 1/2	

1) Data refers to 7 °C leaving chilled water temperature and 35 °C condenser air temperature, according EN14511 standard. 2) Following COMMISSION REGULATION (EU) No 2016/2281 for comfort application chillers. 3) Sound pressure levels calculated at 10 meters. Sound pressure levels refer to ISO standard 3744 with parallel piped shape.

* w: with, w/o: without. ** The data are calculated with variable flow.

Accessories	
PAW-SYSREMKIT	Remote control
PAW-CM000SP041	Cloudgate plug and play IP65 box mobile 4G Europe
PAW-CM000K001	Extension kit and cable gland for mobile (2/4G) antenna (3 m)

Accessories	
PAW-00SRTS011	Tservice wireless fee for 1 year
PAW-SYSSOV1	Shut off valves kit for model 20 - 40



**U - 045/055/065/075 CV****Cooling capacity: 49.8 to 75.8 kW**

High seasonal efficiency and wide range options to meet the exact requirements of your project.

Please contact Panasonic for RRP.



Model			45	55	65	75
Standard without buffer tank			U-045CVNB	U-055CVNB	U-065CVNB	U-075CVNB
With buffer tank			U-045CVBM	U-055CVBM	U-065CVBM	U-075CVBM
Power supply	Voltage	V	400	400	400	400
	Phase		Three phase	Three phase	Three phase	Three phase
	Frequency	Hz	50	50	50	50
Cooling capacity ¹⁾		kW	45.3	52.0	66.1	73.1
Input power ¹⁾		kW	15.4	17.6	21.7	24.0
Total EER 100 % ¹⁾			2.95	2.96	3.05	3.05
SEER ²⁾			4.40	4.53	4.53	4.68
$\eta_{s,c}$ ²⁾		%	173	178	178	184
Startup type			Direct	Direct	Direct	Direct
Maximum operating current		A	40.2	44.2	58.4	64.4
Startup current w/o softstarter / w softstarter		A	133.2/65.8	140.2/72.8	201.4/101.0	206.4/106.0
Sound power (w standard fans)		dB(A)	80.0	80.0	80.0	80.0
Sound pressure (w standard fans) ³⁾		dB(A)	47.8	47.8	47.8	47.8
Dimension (w standard fans) w/o buffer tank	H x W x D	mm	1986 x 2180 x 1160	1986 x 2180 x 1160	1986 x 2180 x 1160	1986 x 2180 x 1160
Dimension (w standard fans) w buffer tank	H x W x D	mm	1986 x 2680 x 1160	1986 x 2680 x 1160	1986 x 2680 x 1160	1986 x 2680 x 1160
Weight (w 1 pump) w/o buffer tank		kg	515	520	580	590
Weight (w 1 pump) w buffer tank		kg	675	680	740	750
Refrigerant (R410A)		kg	14.5	14.9	18.9	19.0
Number of refrigerant circuit			1	1	1	1
Compressors						
Number			2	2	2	2
Type			Scroll	Scroll	Scroll	Scroll
Part load step		%	0/50/100	0/43/57/100	0/40/60/100	0/45/55/100
Crankcase heater		W	2 x 66	2 x 66	2 x 66	2 x 66
Evaporator						
Number			1	1	1	1
Type			Plate	Plate	Plate	Plate
Nominal water flow (cooling)		m ³ /h	8.06	9.18	11.30	12.31
Water pressure drop (cooling)		kPa	30	35	28	37
Water volume		l	4.10	4.10	6.10	6.10
Antifreeze heater		W	30	30	2 x 30	2 x 30
Coils						
Number			1	1	2	2
Frontal surface		m ²	4.20	4.20	5.55	5.55
Number of rows			2	2	2	2
Fans standard						
Number			1	1	2	2
Air flow		m ³ /sec	6.25	6.25	8.33	8.33
Rotation speed		r.p.m.	790	790	650	650
Power input (each fan)		W	1650	1650	930	930
Water connections						
Type			Male gas threaded BSPP ISO 228	Male gas threaded BSPP ISO 228	Male gas threaded BSPP ISO 228	Male gas threaded BSPP ISO 228
Inlet - diameter		Inch	2	2	2	2
Outlet - diameter		Inch	2	2	2	2

1) Data refers to 7 °C leaving chilled water temperature and 35 °C condenser air temperature, according EN14511 standard. 2) Following COMMISSION REGULATION (EU) No 2016/2281 for comfort application chillers. 3) Sound pressure levels calculated at 10 meters. Sound pressure levels refer to ISO standard 3744 with parallel piped shape.

* w: with, w/o: without. ** The data are calculated with variable flow.

Accessories	
PAW-SYSREMKIT	Remote control
PAW-CM000SP041	Cloudgate plug and play IP65 box mobile 4G Europe
PAW-CM000K0001	Extension kit and cable gland for mobile (2/4G) antenna (3 m)

Accessories	
PAW-00SRTS011	Tservice wireless fee for 1 year
PAW-SYSSOV2	Shut off valves kit for model 45 - 75





U - 090/105/125 CV

Cooling capacity: 97.0 to 129.8 kW

Customizable design gives high flexibility. Wide range of communication protocols fulfill the requirements in hotels, offices, industry applications.

Please contact Panasonic for RRP.



Model	90		105		125	
Standard without buffer tank	U-090CVNB		U-105CVNB		U-125CVNB	
With buffer tank	U-090CVBM		U-105CVBM		U-125CVBM	
Power supply	Voltage	V	400	400	400	400
	Phase		Three phase	Three phase	Three phase	Three phase
	Frequency	Hz	50	50	50	50
Cooling capacity ¹⁾		kW	90.7	104.0	123.0	
Input power ¹⁾		kW	30.6	34.9	40.6	
Total EER 100 % ¹⁾			2.96	2.98	3.03	
SEER ²⁾			4.45	4.50	4.55	
η_{s,c} ²⁾		%	175	177	179	
Startup type			Direct	Direct	Direct	
Maximum operating current		A	77.9	86.0	102.0	
Startup current w/o softstarter / w softstarter		A	264.9/127.3	312.0/145.8	350.0/182.6	
Sound power (w standard fans)		dB(A)	83.0	83.0	83.0	
Sound pressure (w standard fans) ³⁾		dB(A)	50.8	50.8	50.8	
Dimension (w standard fans) w/o buffer tank	H x W x D	mm	2286 x 2180 x 1160	2286 x 2180 x 1160	2286 x 2180 x 1160	
Dimension (w standard fans) w buffer tank	H x W x D	mm	2286 x 2680 x 1160	2286 x 2680 x 1160	2286 x 2680 x 1160	
Weight (w 1 pump) w/o buffer tank		kg	750	855	875	
Weight (w 1 pump) w buffer tank		kg	910	1015	1035	
Refrigerant (R410A)		kg	22.0	27.0	28.5	
Number of refrigerant circuit			1	1	1	
Compressors						
Number			2	2	2	
Type			Scroll	Scroll	Scroll	
Part load step		%	0/45/55/100	0/38/62/100	0/33/67/100	
Crankcase heater		W	66/82	66/95	66/95	
Evaporator						
Number			1	1	1	
Type			Plate	Plate	Plate	
Nominal water flow (cooling)		m ³ /h	15.73	18.25	20.95	
Water pressure drop (cooling)		kPa	26	34	45	
Water volume		l	10.80	10.80	10.80	
Antifreeze heater		W	2 x 30	2 x 30	2 x 30	
Coils						
Number			2	2	2	
Frontal surface		m ²	6.4	6.4	6.4	
Number of rows			2	3	3	
Fans standard						
Number			2	2	2	
Air flow		m ³ /sec	11.67	11.67	11.67	
Rotation speed		r.p.m.	790	790	790	
Power input (each fan)		W	1650	1650	1650	
Water connections						
Type			Male gas threaded BSPP ISO 228	Male gas threaded BSPP ISO 228	Male gas threaded BSPP ISO 228	
Inlet - diameter		Inch	2 1/2	2 1/2	2 1/2	
Outlet - diameter		Inch	2 1/2	2 1/2	2 1/2	

1) Data refers to 7 °C leaving chilled water temperature and 35 °C condenser air temperature, according EN14511 standard. 2) Following COMMISSION REGULATION (EU) No 2016/2281 for comfort application chillers. 3) Sound pressure levels calculated at 10 meters. Sound pressure levels refer to ISO standard 3744 with parallel piped shape.

* w: with, w/o: without. ** The data are calculated with variable flow.

Accessories	
PAW-SYSREMKIT	Remote control
PAW-CM000SP041	Cloudgate plug and play IP65 box mobile 4G Europe
PAW-CM000K0001	Extension kit and cable gland for mobile (2/4G) antenna (3 m)

Accessories	
PAW-00SRTS011	Tservice wireless fee for 1 year
PAW-SYSSOV3	Shut off valves kit for model 90 - 125



**U - 140/150/170/190/210 CV****Cooling capacity: 134.0 to 208.8 kW**

Powerful and efficient operation with 4 scroll compressors and superior flexibility with plug and play hydraulic options.

Please contact Panasonic for RRP.



Model			140	150	170	190	210
Standard without buffer tank			U-140CVNB	U-150CVNB	U-170CVNB	U-190CVNB	U-210CVNB
With buffer tank			U-140CVBL	U-150CVBL	U-170CVBL	U-190CVBL	U-210CVBL
Power supply	Voltage	V	400	400	400	400	400
	Phase		Three phase	Three phase	Three phase	Three phase	Three phase
	Frequency	Hz	50	50	50	50	50
Cooling capacity ¹⁾		kW	132.0	146.0	164.0	181.0	208.0
Input power ¹⁾		kW	43.1	47.6	54.8	61.1	69.8
Total EER 100 % ¹⁾			3.06	3.07	2.99	2.96	2.98
SEER ²⁾			4.40	4.45	4.38	4.40	4.25
$\eta_{s,c}$ ²⁾		%	173	175	172	173	167
Startup type			Direct	Direct	Direct	Direct	Direct
Maximum operating current		A	108.0	119.0	136.0	153.0	170.0
Startup current w/o softstarter / w softstarter		A	251/130	262/141	324/161	341/178	396/201
Sound power (w standard fans)		dB(A)	85.4	85.4	87.0	88.1	88.1
Sound pressure (w standard fans) ³⁾		dB(A)	53.4	53.4	55.0	56.1	56.1
Dimension (w standard fans) w/o buffer tank	H x W x D	mm	2295 x 2856 x 2210	2295 x 2856 x 2210	2295 x 2856 x 2210	2295 x 2856 x 2210	2295 x 2856 x 2210
Dimension (w standard fans) w buffer tank	H x W x D	mm	2295 x 3666 x 2210	2295 x 3666 x 2210	2295 x 3666 x 2210	2295 x 3666 x 2210	2295 x 3666 x 2210
Weight (w 1 low Pa pump) w/o buffer tank		kg	1510	1520	1610	1680	1940
Weight (w 1 low Pa pump) w buffer tank		kg	1640	1650	1740	1810	2070
Refrigerant (R410A)		kg	2 x 24.7	2 x 24.7	24.7/33.3	2 x 33.3	2 x 33.3
Number of refrigerant circuit			2	2	2	2	2
Compressors							
Number			4	4	4	4	4
Type			Scroll	Scroll	Scroll	Scroll	Scroll
Part load step		%	0 / 24 / 26 / 48 / 50 / 52 / 74 / 76 / 100	0 / 23 / 27 / 46 / 50 / 54 / 73 / 77 / 100	0 / 20 / 24 / 44 / 45 / 55 / 69 / 80 / 100	0 / 22 / 28 / 44 / 50 / 56 / 72 / 78 / 100	0 / 19 / 31 / 38 / 50 / 62 / 69 / 81 / 100
Crankcase heater		W	4 x 66	4 x 66	3 x 66/82	2 x 82/2 x 66	2 x 95/2 x 66
Evaporator							
Number			1	1	1	1	1
Type			Plate	Plate	Plate	Plate	Plate
Nominal water flow (cooling)		m ³ /h	21.56	23.65	25.95	30.24	33.62
Water pressure drop (cooling)		kPa	33	39	24	32	40
Water volume		l	8.49	8.49	12.21	12.21	12.21
Antifreeze heater		W	60	60	120	120	120
Coils							
Number			4	4	4	4	4
Frontal surface		m ²	11.88	11.88	11.88	11.88	11.88
Number of rows			2+2	2+2	2+3	3+3	3+3
Fans standard							
Number			4	4	4	4	4
Air flow		m ³ /sec	15.56	15.56	19.72	23.89	23.06
Rotation speed		r.p.m.	900	900	900	900	900
Power input (each fan)		W	940	940	940 - 1650	1650	1650
Water connections							
Type			Victaulic	Victaulic	Victaulic	Victaulic	Victaulic
Inlet - diameter		Inch	2 1/2	2 1/2	2 1/2	2 1/2	2 1/2
Outlet - diameter		Inch	2 1/2	2 1/2	2 1/2	2 1/2	2 1/2

1) Data refers to 7 °C leaving chilled water temperature and 35 °C condenser air temperature, according EN14511 standard. 2) Following COMMISSION REGULATION (EU) No 2016/2281 for comfort application chillers. 3) Sound pressure levels calculated at 10 meters. Sound pressure levels refer to ISO standard 3744 with parallel piped shape.
* w: with, w/o: without. ** The data are calculated with variable flow.

Accessories

PAW-SYSREMKIT	Remote control
PAW-CM000SP041	Cloudgate plug and play IP65 box mobile 4G Europe
PAW-CM000K001	Extension kit and cable gland for mobile (2/4G) antenna (3 m)

Accessories

PAW-00SRTS011	Tservice wireless fee for 1 year
PAW-SYSVICTH	Victaulic connection kit for model 140 - 210





Options for cooling only outdoor units

Options table 20 - 125

Option	Type	Ref.	Description	Model															
				20	25	30	35	40	45	55	65	75	90	105	125				
1	Capacity																		
2	Refrigerant and compressor type	V	R410A, fixed speed, cooling only	•	•	•	•	•	•	•	•	•	•	•	•	•	•		
		NB	No buffer	Std	Std	Std	Std	Std	Std	Std	Std	Std	Std	Std	Std	Std	Std	Std	
		BS	Buffer tank (small)	•	•	•	•	•											
3	Buffer tank option	BM	Buffer tank (medium)						•	•	•	•	•	•	•	•	•		
			No pump ¹⁾	Std	Std	Std	Std	Std	Std	Std	Std	Std	Std	Std	Std	Std	Std	Std	
			Single pump	•	•	•	•	•	•	•	•	•	•	•	•	•	•	•	
4	Pump option		Double pump						•	•	•	•	•	•	•	•	•		
			Pump drive - fixed speed ²⁾																
			Pump drive - variable twin speed (single pump) ³⁾	•	•	•	•	•	•	•	•	•	•	•	•	•	•	•	•
			Pump drive - variable twin speed (double pump)							•	•	•	•	•	•	•	•	•	
			Pump drive - variable speed capacity (single pump)	•	•	•	•	•	•	•	•	•	•	•	•	•	•	•	•
			Pump drive - variable speed capacity (double pump)							•	•	•	•	•	•	•	•	•	•
			Pump drive - constant outlet pressure (single pump)	•	•	•	•	•	•	•	•	•	•	•	•	•	•	•	•
			Pump drive - constant outlet pressure (double pump)							•	•	•	•	•	•	•	•	•	•
			Pump drive - constant differential pressure (single pump) ⁴⁾	S0	S0	S0	S0	S0	S0	S0	S0	S0	S0	S0	S0	S0	S0	S0	S0
5	Pump drive option		No hydraulic options	Std	Std	Std	Std	Std	Std	Std	Std	Std	Std	Std	Std	Std	Std		
			Low water pressure sensor ⁵⁾	•	•	•	•	•	•	•	•	•	•	•	•	•	•	•	
			Water isolation valves	•	•	•	•	•	•	•	•	•	•	•	•	•	•	•	•
			No ambient options	Std	Std	Std	Std	Std	Std	Std	Std	Std	Std	Std	Std	Std	Std	Std	
6	Hydraulic options		Finned coil treatment - epoxy	•	•	•	•	•	•	•	•	•	•	•	•	•	•	•	
			Outdoor coil protection grid	•	•	•	•	•	•	•	•	•	•	•	•	•	•	•	•
			Rubber pads	•	•	•	•	•	•	•	•	•	•	•	•	•	•	•	•
			Spring damper	•	•	•	•	•	•	•	•	•	•	•	•	•	•	•	•
			Fan speed control (FSC)	•	•	•	•	•	•	•	•	•	•	•	•	•	•	•	•
			Low noise	Std	Std	Std	Std	Std	•	•	•	•	•	•	•	•	•	•	•
			High pressure fan ⁶⁾	S0	•	•	•	•	•	•	•	•	•	•	•	•	•	•	•
			No miscellaneous options	Std	Std	Std	Std	Std	Std	Std	Std	Std	Std	Std	Std	Std	Std	Std	Std
			Soft starter	•	•	•	•	•	•	•	•	•	•	•	•	•	•	•	•
7	Ambient options		Power supply w/o neutral ⁷⁾	S0	S0	S0	S0	S0	S0	S0	S0	S0	S0	S0	S0	S0	S0		
			Standard BMS option (Modbus RTU)	Std	Std	Std	Std	Std	Std	Std	Std	Std	Std	Std	Std	Std	Std	Std	
			Modbus TCP/IP	•	•	•	•	•	•	•	•	•	•	•	•	•	•	•	•
			BACnet MSTP	•	•	•	•	•	•	•	•	•	•	•	•	•	•	•	•
			BACnet IP	•	•	•	•	•	•	•	•	•	•	•	•	•	•	•	•
			Remote LAN connection	•	•	•	•	•	•	•	•	•	•	•	•	•	•	•	•
			Container transport							•	•	•	•	•	•	•	•	•	•
			Refrigerant gauge							•	•	•	•	•	•	•	•	•	•
			Desuperheater ⁸⁾	•	•	•	•	•	•	•	•	•	•	•	•	•	•	•	•

1) The system may be supplied without a pump, but in order to meet EU ErP compliance, the installation must include a variable speed pump.

2) Fixed speed pump drive on cooling only chiller, is only suitable for installation outside if the EU due to ErP compliance.

3) Variable twin speed drive is supplied as standard with models 20 - 40, when selecting single pump option. Please select alternate pump drive if required.

4) Constant differential pump drive options are only available on a special order and requires additional production time. Please contact your local sales representative.

5) Supplied loose for unit w/o pump.

6) High pressure fan is not available on model 20 due to body design.

7) Power supply without Neutral is only available on a special order basis, and requires additional production time. Please contact your local sales representative.

8) Inclusion of desuperheater will extend standard production time, please contact your local Panasonic sales representative for details.

Std: Standard item included.

•: Optional item that can be selected.

S0: Special order item.



Options table 140 - 210

Option	Type	Ref.	Description	Model				
				140	150	170	190	210
1	Capacity							
2	Refrigerant and compressor type	V	R410A, fixed speed, cooling only	•	•	•	•	•
3	Buffer tank option	NB	No buffer	Std	Std	Std	Std	Std
		BL	Buffer tank (large)	•	•	•	•	•
4	Pump option		No pump ¹⁾	Std	Std	Std	Std	Std
			Single pump low pressure	•	•	•	•	•
			Single pump high pressure	•	•	•	•	•
			Double pump low pressure	•	•	•	•	•
			Double pump high pressure	•	•	•	•	•
			Pump drive - fixed speed ²⁾					
			Pump drive - variable twin speed (single pump)	•	•	•	•	•
			Pump drive - variable twin speed (double pump)	•	•	•	•	•
5	Pump drive option		Pump drive - variable speed capacity (single pump)	•	•	•	•	•
			Pump drive - variable speed capacity (double pump)	•	•	•	•	•
			Pump drive - constant outlet pressure (single pump)	•	•	•	•	•
			Pump drive - constant outlet pressure (double pump)	•	•	•	•	•
			Pump drive - constant differential pressure (single pump) ³⁾	S0	S0	S0	S0	S0
			Pump drive - constant differential pressure (double pump) ³⁾	S0	S0	S0	S0	S0
			No hydraulic options	Std	Std	Std	Std	Std
			Low water pressure sensor ⁴⁾	•	•	•	•	•
6	Hydraulic options		Water isolation valves	•	•	•	•	•
			Hydraulic gauges	•	•	•	•	•
			No ambient options	Std	Std	Std	Std	Std
			Finned coil treatment - epoxy	•	•	•	•	•
7	Ambient options		Outdoor coil protection grid	•	•	•	•	•
			Rubber pads	•	•	•	•	•
			Spring damper	•	•	•	•	•
			Fan speed control (FSC)	•	•	•	•	•
			Low noise	Std	Std	Std	Std	Std
			No miscellaneous options	Std	Std	Std	Std	Std
			Soft starter	•	•	•	•	•
			Power supply w/o neutral	•	•	•	•	•
8	Miscellaneous options		Standard BMS option (Modbus RTU)	Std	Std	Std	Std	Std
			Modbus TCP/IP	•	•	•	•	•
			BACnet IP	•	•	•	•	•
			Remote LAN connection	Std	Std	Std	Std	Std
			Container transport	•	•	•	•	•
			Refrigerant gauge	•	•	•	•	•

1) The system may be supplied without a pump, but in order to meet EU ErP compliance, the installation must include a variable speed pump.

2) Fixed speed pump drive on cooling only chiller, is only suitable for installation outside of the EU due to ErP compliance.

3) Constant differential pump drive options are only available on a special order and requires additional production time. Please contact your local sales representative.

4) Supplied loose for unit w/o pump.

Std: Standard item included.

•: Optional item that can be selected.

S0: Special order item.

Fan coils highlighted features

Available in a wide range of designs, the fan coils are perfectly adapted to fit within almost any location.





1 Innovation for optimum comfort

Range of fan coil for heating and cooling with capacities from 0.5 to 21.9 kW in cooling and from 0.6 to 21.5 kW in heating. Bring full year comfort with water based systems.

2 Energy efficient and low noise fan

Dynamically balanced and specially designed fans, reinforced acoustic insulation and optimised fan speed staging for lower noise levels. Improved efficiency with optional EC fan motor.

3 Quality and efficient coil

Constructed from staggered copper tubes, mechanically expanded into aluminium fins, providing maximum heat transfer efficiency, durability and hygiene.

4 Flexible installation

Various types of unit to fit your needs with flexible installation options. A choice of service side for hydraulic connections, piping configuration and horizontal or vertical installation for ducted units.

Offering a great range of capacities and performance, available in a wide range of designs, the fan coils are perfectly adapted to fit within almost any location. Whether the requirements are for cooling only, or for both heating and cooling, there is a fan coil to suit. With a variety of piping and fan configuration, the range is capable of meeting the most stringent of requirements. Line up available in AC and EC fans, it is possible to achieve both powerful performance, but with sustainability in mind.

Controllers with sophisticated designs, provide a user friendly interface while enabling an easy and low cost integration to building management systems.



PAW-FC-RC1

Optional wired remote controller for AC fan, 2-pipe and 4-pipe application.



PAW-FC-TC903

Optional wired remote controller for AC fan 2-pipe application.



PAW-FC-907TC

Optional wired remote controller for EC fan, 2-pipe and 4-pipe application.

Range of fan coils

Page	Fan Type	Operation	Capacity range	0 kW	1 kW	2 kW	3 kW	4 kW	
P. 198	Ducted	AC	Cooling	0.7 to 8.1 kW	[Blue bar]				
			Heating	0.7 to 10.3 kW	[Orange bar]				
	EC	Cooling	0.5 to 9.6 kW	[Blue bar]					
		Heating	0.6 to 13.6 kW	[Orange bar]					
P. 200	High static pressure ducted	AC	Cooling	4.1 to 21.9 kW	[Blue bar]			[Blue bar]	
			Heating	4.7 to 21.5 kW	[Orange bar]			[Orange bar]	
	EC	Cooling	6.6 to 21.4 kW	[Blue bar]			[Blue bar]		
		Heating	5.9 to 21.4 kW	[Orange bar]			[Orange bar]		
P. 202	4 way cassette	AC	Cooling	1.4 to 8.6 kW	[Blue bar]				
			Heating	1.1 to 12.8 kW	[Orange bar]				
	EC	Cooling	1.4 to 9.4 kW	[Blue bar]					
		Heating	1.1 to 14.0 kW	[Orange bar]					
P. 204	Ceiling chassis	AC	Cooling	0.7 to 8.1 kW	[Blue bar]				
			Heating	0.7 to 10.3 kW	[Orange bar]				
	EC	Cooling	0.5 to 9.6 kW	[Blue bar]					
		Heating	0.6 to 13.6 kW	[Orange bar]					
P. 206	Floor-standing chassis	AC	Cooling	0.7 to 8.1 kW	[Blue bar]				
			Heating	0.7 to 10.3 kW	[Orange bar]				
	EC	Cooling	0.5 to 9.6 kW	[Blue bar]					
		Heating	0.6 to 13.6 kW	[Orange bar]					
P. 208	Wall-mounted	AC	Cooling	1.0 to 3.9 kW	[Blue bar]				
			Heating	1.4 to 4.1 kW	[Orange bar]				
P. 209	Smart fan coils	AC	Cooling	0.2 to 1.7 kW	[Blue bar]				
			Heating	0.2 to 1.7 kW	[Orange bar]				

Values indicated are for the full operating range. The data shown within the tables following are indicative of specific installation conditions. For full details relating to performance and operating conditions, please refer to the technical data manual.

5 kW 6 kW 7 kW 8 kW 9 kW 10kW 11kW 12kW 13kW 14kW 15kW 16kW 17kW 18kW 19kW 20kW 21kW 22kW

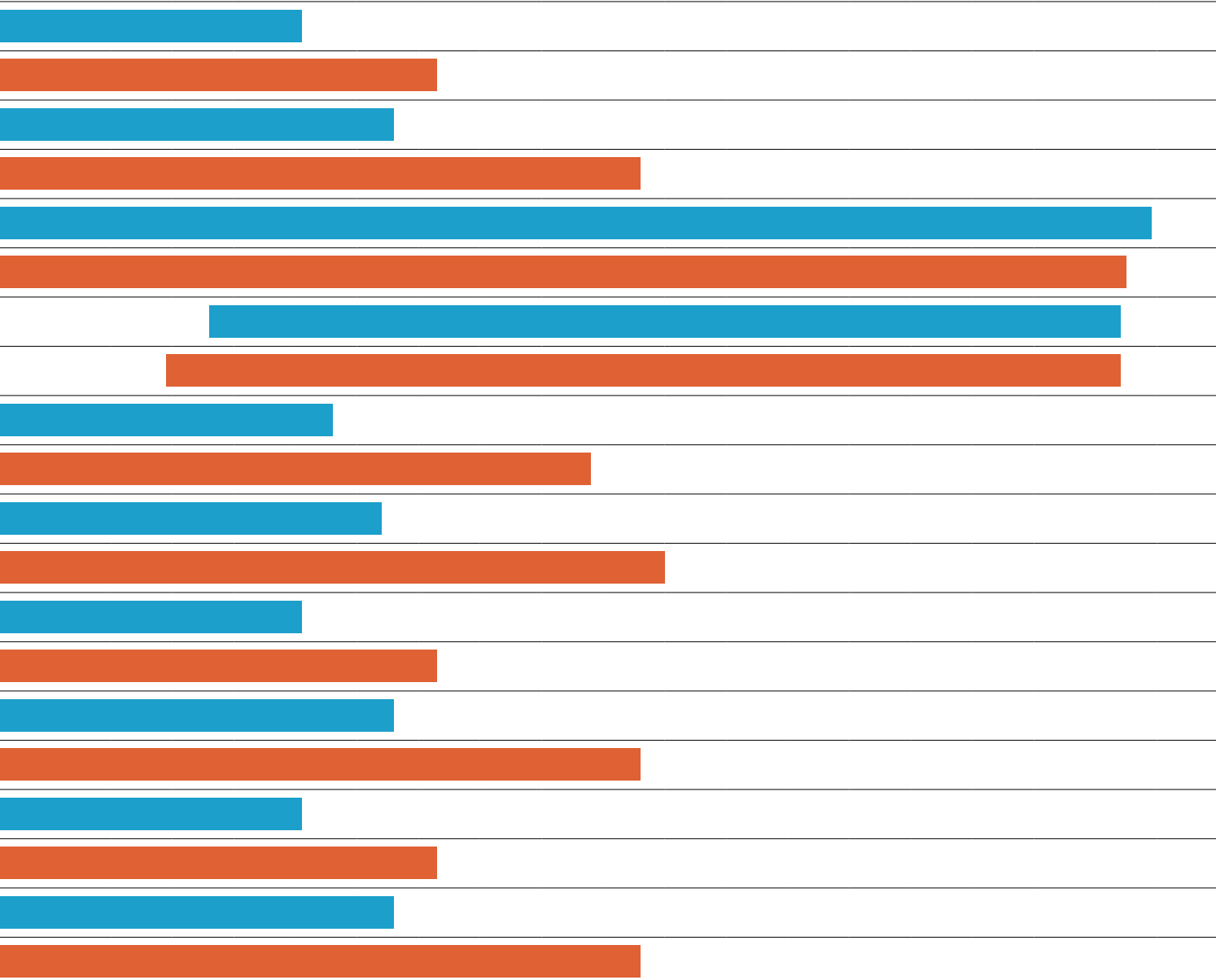

Fan coils - ducted (AC)



Optional controller.
Wired remote controller.
PAW-FC-903TC



Optional controller.
Advanced wired remote controller.
PAW-FC-RC1

2-pipe - Left connection (PAW-)			FC2A-D010L	FC2A-D020L	FC2A-D030L	FC2A-D040L	FC2A-D050L	FC2A-D060L	FC2A-D070L	FC2A-D080L
2-pipe - Right connection (PAW-)			FC2A-D010R	FC2A-D020R	FC2A-D030R	FC2A-D040R	FC2A-D050R	FC2A-D060R	FC2A-D070R	FC2A-D080R
Total cooling capacity ¹⁾	Lo/Med/Hi	kW	0.7/1.0/1.5	0.7/1.2/1.7	1.0/2.0/2.5	1.2/2.4/3.2	1.7/3.2/4.6	2.7/4.6/5.8	3.4/6.1/7.3	4.6/6.1/8.1
Sensible cooling capacity ¹⁾	Lo/Med/Hi	kW	0.5/0.8/1.1	0.6/0.9/1.3	0.8/1.5/1.9	0.9/1.8/2.3	1.2/2.2/3.3	1.9/3.3/4.5	2.4/4.3/5.1	3.4/4.6/6.3
Water flow	Lo/Med/Hi	l/h	124/172/250	127/213/289	172/341/430	206/413/547	296/544/798	466/784/1003	587/1058/1252	798/1048/1400
Water pressure drop	Lo/Med/Hi	kPa	10.7/19.5/39.2	1.9/3.9/6.3	6.3/19.3/28.8	5.4/17.1/28.0	7.5/22.8/46.9	13.9/37.4/60.2	4.8/15.4/21.5	11.9/19.3/32.5
Heating capacity ²⁾	Lo/Med/Hi	kW	0.9/1.4/2.0	0.9/1.5/2.2	1.3/2.4/3.1	1.4/2.9/4.0	2.1/4.1/5.7	3.1/5.3/7.1	4.3/7.9/9.3	5.9/8.1/11.6
4-pipe - Left connection (PAW-)			FC4A-D010L	FC4A-D020L	FC4A-D030L	FC4A-D040L	FC4A-D050L	FC4A-D060L	FC4A-D070L	FC4A-D080L
4-pipe - Right connection (PAW-)			FC4A-D010R	FC4A-D020R	FC4A-D030R	FC4A-D040R	FC4A-D050R	FC4A-D060R	FC4A-D070R	FC4A-D080R
Total cooling capacity ¹⁾	Lo/Med/Hi	kW	0.7/0.9/1.3	0.6/1.1/1.6	1.0/1.9/2.4	1.1/2.3/3.0	1.7/3.0/4.3	2.6/4.4/5.6	3.3/5.9/6.9	4.5/5.9/8.0
Sensible cooling capacity ¹⁾	Lo/Med/Hi	kW	0.5/0.7/1.0	0.5/0.8/1.2	0.8/1.5/1.8	0.8/1.7/2.2	1.2/2.2/3.1	1.8/3.2/4.3	2.3/4.2/4.9	3.3/4.4/6.2
Water flow	Lo/Med/Hi	l/h	114/159/225	109/192/268	165/327/414	194/388/517	284/522/748	449/756/967	575/1019/1193	775/1020/1380
Water pressure drop	Lo/Med/Hi	kPa	8.3/15.2/29.0	1.5/3.4/5.6	3.0/9.5/14.4	6.4/22.3/36.8	4.2/12.8/25.1	10.2/27.7/44.5	5.9/17.9/24.4	19.3/31.1/53.6
Heating capacity ²⁾	Lo/Med/Hi	kW	0.5/0.7/1.0	0.6/0.9/1.1	1.0/1.4/1.6	0.9/1.6/2.1	1.5/2.3/3.0	1.9/2.9/3.7	2.7/3.6/4.3	3.9/5.6/7.1
Water flow	Lo/Med/Hi	l/h	79/127/178	100/146/190	164/232/274	160/273/354	251/401/508	325/505/633	456/626/736	673/963/1226
Water pressure drop	Lo/Med/Hi	kPa	1.9/3.5/5.6	1.5/3.2/5.3	5.1/9.0/11.9	9.2/26.5/42.7	10.7/24.6/29.5	20.3/43.9/52.9	67.2/117.9/137.8	33.1/63.7/75
Sound levels										
Global sound power	Lo/Med/Hi	dB(A)	33/40/49	31/43/50	30/45/52	30/44/51	34/46/56	38/51/58	43/56/61	50/55/64
Global sound pressure ³⁾	Lo/Med/Hi	dB(A)	24/31/40	22/34/41	21/36/43	21/35/42	25/37/47	29/42/49	34/47/52	41/46/55
Fan										
Number			1	1	1	2	2	2	2	3
Air flow 2-pipe	Lo/Med/Hi	m ³ /sec	0.03/0.05/0.08	0.03/0.05/0.07	0.04/0.08/0.11	0.05/0.10/0.14	0.07/0.14/0.20	0.10/0.18/0.26	0.13/0.25/0.30	0.18/0.26/0.39
Air flow 4-pipe	Lo/Med/Hi	m ³ /sec	0.03/0.05/0.07	0.02/0.04/0.07	0.04/0.07/0.10	0.05/0.09/0.13	0.07/0.13/0.19	0.09/0.17/0.25	0.13/0.24/0.28	0.18/0.25/0.38
Maximum external pressure		Pa	55	55	65	85	85	115	125	70
Filter			G2	G2	G2	G2	G2	G2	G2	G2
Electrical data										
Power supply	Voltage	V	230	230	230	230	230	230	230	230
	Phase		Single phase	Single phase	Single phase	Single phase	Single phase	Single phase	Single phase	Single phase
	Frequency	Hz	50/60	50/60	50/60	50/60	50/60	50/60	50/60	50/60
Power consumption 2-pipe	Lo/Med/Hi	W	13/24/36	10/18/29	16/37/45	15/37/56	28/55/72	37/75/105	53/100/147	90/112/188
Power consumption 4-pipe	Lo/Med/Hi	W	13/24/36	10/18/28	16/37/44	15/37/55	28/54/70	37/74/104	53/99/145	90/112/188
Water connections										
Type			Female gas threaded	Female gas threaded	Female gas threaded	Female gas threaded	Female gas threaded	Female gas threaded	Female gas threaded	Female gas threaded
2-pipe		Inch	1/2	1/2	1/2	1/2	1/2	1/2	3/4	3/4
	Cooling	Inch	1/2	1/2	1/2	1/2	1/2	1/2	3/4	3/4
4-pipe	Heating	Inch	1/2	1/2	1/2	1/2	1/2	1/2	1/2	1/2
Dimensions and weight										
Dimension	H x W x D	mm	220 x 570 x 430	220 x 570 x 430	220 x 730 x 430	220 x 938 x 430	220 x 1122 x 430	220 x 1307 x 430	220 x 1121 x 530	220 x 1316 x 530
Weight	2 / 4-pipes	kg	13/14	13/14	15/16	20/22	22/24	26/28	27/29	38/40
2-pipe RRP		£	276	290	310	361	404	437	497	712
4-pipe RRP		£	305	309	333	388	434	472	536	764

1) According to Eurovent standard. Air: 27 °C DB / 19 °C WB. Water in / out: 7 °C / 12 °C. 2) Air: 20 °C. Water in / out: 50 °C / 45 °C. 3) The sound pressure levels are based on (NR) characteristics of a room having volume of 100 m³ with reverberation of 0.5 seconds. Values indicated are for 0 Pa external static pressure, for additional pressure characteristics, please refer the selection software.

Technical focus

- Cooling capacity from 0.7 to 8.1 kW
- Heating capacity from 0.7 to 10.3 kW
- 5-speed AC fan motor(s)

Operating limits

Entering water temperature	From 5 to 90 °C
Indoor air temperature	From 5 to 32 °C

Main features and accessories

- 2 and 4-pipe configurations
- Left or right hand arrangements
- Ease of installation
- Very low acoustic levels
- 2 way or 3 way ON / OFF valves
- Auxiliary drain pan
- Air intake with removable grid
- G2 filter



Fan coils - ducted (EC)

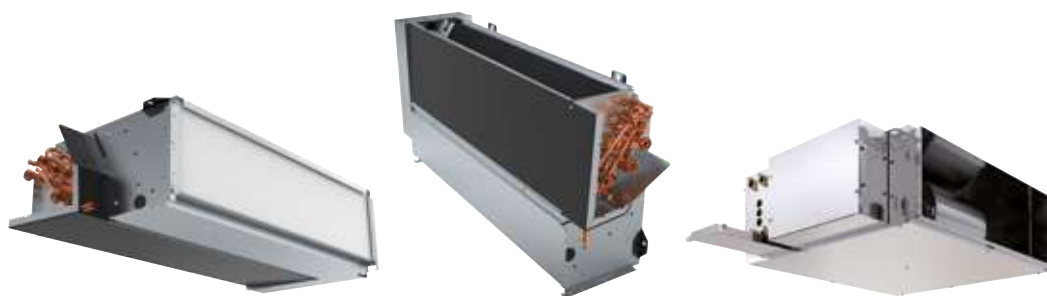

Optional controller.
Wired remote
controller for EC fans.
PAW-FC-907TC

2-pipe - Left connection (PAW-)		FC2E-D010L	FC2E-D020L	FC2E-D030L	FC2E-D040L	FC2E-D050L	FC2E-D060L	FC2E-D070L	FC2E-D080L	FC2E-F040L	
2-pipe - Right connection (PAW-)		FC2E-D010R	FC2E-D020R	FC2E-D030R	FC2E-D040R	FC2E-D050R	FC2E-D060R	FC2E-D070R	FC2E-D080R	FC2E-F040R	
Total cooling capacity ¹⁾	Lo/Med/Hi kW	0.6/1.2/2.1	0.6/1.4/2.4	0.9/2.1/3.1	1.3/2.9/4.2	1.3/4.0/5.0	2.0/4.5/5.2	2.7/5.9/6.9	5.1/6.5/8.8	3.6/6.6/9.2	
Sensible cooling capacity ¹⁾	Lo/Med/Hi kW	0.5/1.1/1.9	0.5/1.1/1.9	0.6/1.6/2.4	1.0/2.1/3.0	1.1/3.0/3.7	1.4/3.5/4.0	2.0/4.3/5.2	3.7/4.8/6.6	2.9/6.1/9.1	
Water flow	Lo/Med/Hi l/h	107/210/356	110/237/406	148/354/532	230/506/722	231/685/743	341/767/800	463/1008/1098	879/1111/1254	627/1142/1575	
Water pressure drop	Lo/Med/Hi kPa	8.2/28.2/76.9	1.5/4.6/11.0	5.0/20.5/42.1	6.4/24.4/46.3	4.9/35.1/41.0	7.8/35.8/38.8	3.0/14.0/16.6	14.1/21.4/26.6	10.6/51.2/93.8	
Heating capacity ²⁾	Lo/Med/Hi kW	0.8/1.6/2.9	0.9/1.9/3.3	1.0/2.2/3.4	1.4/3.0/5.3	1.7/5.2/5.5	2.3/5.9/6.1	3.8/7.3/8.2	6.2/8.0/9.3	4.4/8.3/11.8	
4-pipe - Left connection (PAW-)		FC4E-D010L	FC4E-D020L	FC4E-D030L	FC4E-D040L	FC4E-D050L	FC4E-D060L	FC4E-D070L	FC4E-D080L	FC4E-F040L	
4-pipe - Right connection (PAW-)		FC4E-D010R	FC4E-D020R	FC4E-D030R	FC4E-D040R	FC4E-D050R	FC4E-D060R	FC4E-D070R	FC4E-D080R	FC4E-F040R	
Total cooling capacity ¹⁾	Lo/Med/Hi kW	0.5/1.1/1.9	0.6/1.2/2.2	0.8/1.9/2.9	1.2/2.7/4.0	1.2/3.6/4.6	1.8/4.1/4.9	2.6/5.1/6.4	5.0/6.2/9.6	3.3/6.4/8.8	
Sensible cooling capacity ¹⁾	Lo/Med/Hi kW	0.4/0.9/1.7	0.4/1.0/1.8	0.6/1.5/2.2	0.9/1.9/2.8	1.0/2.8/3.5	1.2/3.2/3.8	1.9/3.8/4.8	3.6/4.6/7.2	2.7/5.6/8.0	
Water flow	Lo/Med/Hi l/h	92/185/327	97/206/375	129/321/493	205/457/681	212/625/686	306/707/749	443/886/977	855/1070/1242	567/1093/1511	
Water pressure drop	Lo/Med/Hi kPa	5.8/20.1/59.2	1.3/3.7/9.7	4.0/9.2/19.7	6.3/29.6/60.1	2.5/17.9/21.3	5.1/24.3/27.2	3.5/13.6/16.5	22.9/33.9/44.3	10.0/47.2/86.7	
Heating capacity ²⁾	Lo/Med/Hi kW	0.4/0.8/1.4	0.6/0.9/1.5	1.0/1.4/1.8	1.2/2.0/2.8	1.6/2.4/2.5	1.4/2.9/3.1	2.5/3.4/3.6	4.5/5.9/6.9	2.5/4.5/6.2	
Water flow	Lo/Med/Hi l/h	76/140/235	95/161/255	166/243/304	204/350/483	267/416/438	233/503/531	434/583/614	767/1011/1194	432/783/1065	
Water pressure drop	Lo/Med/Hi kPa	1.8/4.0/8.4	1.4/3.8/9.4	5.3/9.7/14.1	15.6/41.8/76.3	11.9/26.3/28.9	11.5/43.6/48.1	61.5/103.8/113.9	42.1/69.7/95.1	30.6/107.6/214.8	
Sound levels											
Global sound power	Lo/Med/Hi dB[A]	34/47/60	34/47/60	31/50/59	29/44/52	30/51/57	32/54/58	40/54/59	51/56/64	42/58/68 ³⁾	
Global sound pressure ⁴⁾	Lo/Med/Hi dB[A]	25/38/51	25/38/51	22/41/50	20/35/43	21/42/48	23/45/49	31/45/50	42/47/55	23/39/52	
Fan											
Number		1	1	1	2	2	2	2	3	1	
Air flow 2-pipe	Lo/Med/Hi m ³ /sec	0.03/0.06/0.12	0.03/0.07/0.11	0.04/0.11/0.16	0.05/0.11/0.19	0.06/0.18/0.23	0.07/0.20/0.25	0.10/0.24/0.29	0.19/0.26/0.39	0.16/0.36/0.54	
Air flow 4-pipe	Lo/Med/Hi m ³ /sec	0.03/0.06/0.11	0.02/0.06/0.11	0.03/0.10/0.15	0.04/0.10/0.17	0.05/0.16/0.18	0.06/0.19/0.20	0.09/0.22/0.25	0.18/0.25/0.30	0.15/0.34/0.52	
Maximum external pressure	Pa	75	75	75	105	70	105	115	115	190	
Filter		G2	G2	G2	G2	G2	G2	G2	G2	G2	
Electrical data											
Power supply	Voltage	V	230	230	230	230	230	230	230	230	
	Phase		Single phase	Single phase	Single phase	Single phase	Single phase	Single phase	Single phase	Single phase	
	Frequency	Hz	50/60	50/60	50/60	50/60	50/60	50/60	50/60	50/60	
Power consumption 2-pipe	Lo/Med/Hi W	5/11/41	5/13/41	4/16/42	2/13/43	4/24/46	2/30/54	11/44/77	23/42/108	11/62/197	
Power consumption 4-pipe	Lo/Med/Hi W	5/11/39	5/13/40	6/15/40	2/12/42	2/23/44	2/28/52	11/43/75	22/41/116	11/60/188	
Water connections											
Type		Female gas threaded	Female gas threaded	Female gas threaded	Female gas threaded	Female gas threaded	Female gas threaded	Female gas threaded	Female gas threaded	Female gas threaded	
2-pipe	Inch	1/2	1/2	1/2	1/2	1/2	1/2	3/4	3/4	3/4	
	Cooling	Inch	1/2	1/2	1/2	1/2	1/2	3/4	3/4	3/4	
4-pipe	Heating	Inch	1/2	1/2	1/2	1/2	1/2	1/2	1/2	1/2	
Dimensions and weight											
Dimension	H x W x D	mm	220 x 570 x 430	220 x 570 x 430	220 x 730 x 430	220 x 938 x 430	220 x 1122 x 430	220 x 1307 x 430	220 x 1121 x 530	220 x 1316 x 530	223 x 1233 x 653
Weight	2 / 4-pipes	kg	13/14	13/14	15/16	20/22	22/24	26/28	27/29	38/40	19/19
2-pipe RRP		£	444	457	479	528	571	605	666	1.032	
4-pipe RRP		£	471	477	500	556	600	640	708	1.104	

1) According to Eurovent standard. Air: 27 °C DB / 19 °C WB. Water in / out: 7 °C / 12 °C. 2) Air: 20 °C. Water in / out: 50 °C / 45 °C. 3) The sound power levels indicated are from return and radiated measurements. 4) The sound pressure levels are based on [NR] characteristics of a room having volume of 100 m³ with reverberation of 0.5 seconds. Values indicated are for 0 Pa external static pressure, for additional pressure characteristics, please refer the selection software.

Technical focus

- Cooling capacity from 0.5 to 9.6 kW
- Heating capacity from 0.6 to 13.6 kW
- Low energy consumption EC fan(s)

Operating limits

Entering water temperature	From 5 to 90 °C
Indoor air temperature	From 5 to 32 °C

Main features and accessories

- 2 and 4-pipe configurations
- Left or right hand arrangements
- Can be installed both horizontally and vertically*
- Ease of installation
- Very low acoustic levels
- 2 way or 3 way ON / OFF valves
- Auxiliary drain pan
- Air intake with removable grid
- G2 filter

* PAW-FC2E-F040 and PAW-FC4E-F040 may only be installed horizontally.



Fan coils - high static pressure ducted (AC)



Optional controller.
Wired remote controller.
PAW-FC-903TC



Optional controller.
Advanced wired remote controller.
PAW-FC-RC1

2-pipe - Left connection			PAW-FC2A-E070L	PAW-FC2A-E150L	PAW-FC2A-E180L	PAW-FC2A-E210L	PAW-FC2A-E240L*	PAW-FC2A-E270L*
2-pipe - Right connection			PAW-FC2A-E070R	PAW-FC2A-E150R	PAW-FC2A-E180R	PAW-FC2A-E210R	PAW-FC2A-E240R*	PAW-FC2A-E270R*
Total cooling capacity ¹⁾	Lo/Med/Hi	kW	4.4/5.5/6.4	5.6/11.5/14.2	4.9/11.5/15.0	5.2/13.7/18.6	14.3/19.8/23.3	15.8/23.0/27.5
Sensible cooling capacity ¹⁾	Lo/Med/Hi	kW	3.12/5.1	3.9/9.2/12.2	3.7/9.5/13.1	3.5/9.9/13.7	10.3/14.9/17.8	11.0/16.3/19.7
Water flow	Lo/Med/Hi	l/h	749/951/1095	966/1979/2437	837/1979/2589	899/2357/3201	2468/3410/4015	2718/3951/4740
Water pressure drop	Lo/Med/Hi	kPa	26.5/42.5/56.2	5.5/19.9/29.3	4.4/19.6/32.0	4.9/28.8/51.5	13.8/25.2/34.2	12.8/25.2/35.3
Heating capacity ²⁾	Lo/Med/Hi	kW	5.4/8.6/12.7	6.2/14.2/20.0	6.3/16.3/23.2	6.1/16.5/23.4	17.2/26.3/32.6	17.9/27.5/33.7
4-pipe - Left connection			PAW-FC4A-E070L	PAW-FC4A-E150L	PAW-FC4A-E180L	PAW-FC4A-E210L	PAW-FC4A-E240L*	PAW-FC4A-E270L*
4-pipe - Right connection			PAW-FC4A-E070R	PAW-FC4A-E150R	PAW-FC4A-E180R	PAW-FC4A-E210R	PAW-FC4A-E240R*	PAW-FC4A-E270R*
Total cooling capacity ¹⁾	Lo/Med/Hi	kW	4.0/5.4/6.0	5.3/10.1/11.9	5.5/11.2/13.6	5.9/14.4/18.8	13.3/17.7/20.5	14.3/19.9/23.4
Sensible cooling capacity ¹⁾	Lo/Med/Hi	kW	2.8/4.1/4.7	3.7/8.4/10.9	3.9/9.1/12.0	4.0/10.6/14.5	9.9/13.9/16.3	10.3/14.9/17.8
Water flow	Lo/Med/Hi	l/h	680/924/1035	919/1739/2044	951/1928/2335	1013/2478/3241	2291/3053/3526	2464/3427/4032
Water pressure drop	Lo/Med/Hi	kPa	29.7/52.1/64.4	4.1/13.5/18.4	4.7/17.4/25.0	6.6/35.2/59.1	14.5/25.0/33.0	12.8/23.3/31.5
Heating capacity ²⁾	Lo/Med/Hi	kW	3.7/6.0/7.4	5.3/11.8/15.9	5.3/11.9/15.9	5.3/11.9/16.0	7.2/11.1/13.5	7.2/11.1/13.5
Water flow	Lo/Med/Hi	l/h	636/1029/1266	906/2038/2746	911/2045/2745	916/2051/2747	1242/1910/2329	1242/1910/2329
Water pressure drop	Lo/Med/Hi	kPa	14.2/30.7/43.6	39.0/167.6/293.0	23.9/100.8/174.3	24.2/101.4/174.6	45.8/87.8/120.3	28.3/53.3/72.5
Sound levels								
Sound power return + radiated	Lo/Med/Hi	dB[A]	54/60/63	52/66/72	54/66/74	52/66/72	65/73/75	65/73/75
Sound power discharge	Lo/Med/Hi	dB[A]	53/59/62	52/64/71	52/64/71	52/64/71	64/72/75	64/72/75
Sound pressure ³⁾	Lo/Med/Hi	dB[A]	33/39/42	31/45/51	31/45/51	31/45/51	44/52/54	44/52/54
Fan								
Number			1	1	1	1	1	1
Air flow 2-pipe	Lo/Med/Hi	m ³ /sec	0.19/0.30/0.43	0.19/0.59/0.89	0.19/0.59/0.89	0.19/0.59/0.89	0.54/0.87/1.09	0.54/0.87/1.09
Air flow 4-pipe	Lo/Med/Hi	m ³ /sec	0.15/0.31/0.42	0.19/0.59/0.89	0.19/0.59/0.89	0.19/0.59/0.89	0.54/0.87/1.09	0.54/0.87/1.09
Maximum external pressure		Pa	110	200	200	200	220	220
Filter			G3	G3	G3	G3	G3	G3
Electrical data								
Power supply	Voltage	V	230	230	230	230	230	230
	Phase		Single phase	Single phase	Single phase	Single phase	Single phase	Single phase
	Frequency	Hz	50/60	50/60	50/60	50/60	50/60	50/60
Power consumption	Lo/Med/Hi	W	132/182/222	180/421/675	180/421/675	180/421/675	420/530/673	420/530/673
Water connections								
Type			Female gas threaded	Gas Male threaded	Gas Male threaded	Gas Male threaded	Gas Male threaded	Gas Male threaded
2-pipe	Inch		1/2	1	1 1/4	1 1/4	1 1/4	1 1/4
	Cooling	Inch	1/2	1	1	1	1 1/4	1 1/4
4-pipe	Heating	Inch	1/2	3/4	3/4	3/4	3/4	3/4
Dimensions and weight								
Dimension	H x W x D	mm	250 x 698 x 1200	375 x 798 x 1380	375 x 798 x 1380	375 x 798 x 1380	450 x 798 x 1500	450 x 798 x 1500
Weight		kg	42	63	65	67	76	80
2-pipe RRP		£	815	1.015	1.110	1.174	1.295	1.380
4-pipe RRP		£	854	1.085	1.180	1.246	1.367	1.455

1) According to Eurovent standard. Air: 27 °C DB / 19 °C WB. Water in / out: 7 °C / 12 °C. 2) Air: 20 °C. Water in / out: 50 °C / 45 °C. 3) Informative data: Considering an hypothetical sound attenuation of the room and installation of 21 dB.

Values indicated are for 50 Pa external static pressure, for additional pressure characteristics, please refer the selection software.

* High fan speed used for capacity, water flow, sound and air flow values.

Technical focus

- 6 sizes
- Cooling capacity from 4.1 to 21.9 kW
- Heating capacity from 4.7 to 21.5 kW
- 5-speed AC fan motor

Main features and accessories

- 2 and 4-pipe, left and right hand configurations
- Static pressure up to 220Pa
- Double skin insulation
- 2 way or 3 way ON / OFF valves
- Auxiliary drain pan
- Air intake with removable grid
- G3 filter

Operating limits	
Entering water temperature	From 5 to 90 °C
Indoor air temperature	From 5 to 32 °C



Fan coils - high static pressure ducted (EC)



Optional controller.
Wired remote
controller for EC fans.
PAW-FC-907TC

2-pipe - Left connection			PAW-FC2E-E150L	PAW-FC2E-E180L	PAW-FC2E-E210L	PAW-FC2E-E240L	PAW-FC2E-E270L
2-pipe - Right connection			PAW-FC2E-E150R	PAW-FC2E-E180R	PAW-FC2E-E210R	PAW-FC2E-E240R	PAW-FC2E-E270R
Total cooling capacity ¹⁾	Lo/Med/Hi	kW	7.0/11.3/14.5	7.8/13.1/17.3	8.6/14.2/19.0	9.3/16.1/20.3	10.2/18.1/23.1
Sensible cooling capacity ¹⁾	Lo/Med/Hi	kW	5.2/9.1/12.1	5.7/10.3/14.1	6.1/10.9/15.0	6.7/12.4/16.2	7.2/13.6/17.8
Water flow	Lo/Med/Hi	l/h	1207/1945/2498	1351/2259/2979	1476/2451/3275	1592/2766/3498	1751/3120/3972
Water pressure drop	Lo/Med/Hi	kPa	11.5/19.3/30.7	6.1/24.9/41.5	6.0/31.0/53.8	6.3/17.1/26.4	5.9/16.4/25.4
Heating capacity ²⁾	Lo/Med/Hi	kW	88/15.8/20.7	9.5/17.9/24.3	10.0/19.4/26.8	11.1/20.8/27.5	11.7/22.8/30.4
4-pipe - Left connection			PAW-FC4E-E150L	PAW-FC4E-E180L	PAW-FC4E-E210L	PAW-FC4E-E240L	PAW-FC4E-E270L
4-pipe - Right connection			PAW-FC4E-E150R	PAW-FC4E-E180R	PAW-FC4E-E210R	PAW-FC4E-E240R	PAW-FC4E-E270R
Total cooling capacity ¹⁾	Lo/Med/Hi	kW	5.9/9.1/11.6	6.6/10.2/13.0	7.9/12.6/16.4	8.4/14.0/17.5	8.9/15.3/19.5
Sensible cooling capacity ¹⁾	Lo/Med/Hi	kW	4.5/7.6/10.1	4.9/8.4/11.2	5.8/9.9/13.4	6.2/11.0/14.2	6.5/11.8/15.5
Water flow	Lo/Med/Hi	l/h	1011/1567/2005	1141/1764/2243	1361/2175/2826	1447/2409/3020	1529/2641/3359
Water pressure drop	Lo/Med/Hi	kPa	4.9/11.1/17.7	6.5/14.7/23.2	7.6/27.5/45.4	6.2/15.9/24.5	5.5/14.5/22.4
Heating capacity ²⁾	Lo/Med/Hi	kW	3.6/5.8/7.3	6.1/10.0/12.8	6.1/10.1/12.9	4.8/8.3/10.3	4.7/8.2/10.5
Water flow	Lo/Med/Hi	l/h	621/991/1264	1052/1729/2211	1057/1734/2227	832/1421/1780	804/1407/1804
Water pressure drop	Lo/Med/Hi	kPa	20.7/45.6/70.1	30.7/74.1/116.4	30.8/74.5/118.0	19.6/55.9/78.7	7.2/33.9/48.9
Sound levels							
Sound power return + radiated	Lo/Med/Hi	dB(A)	56/67/74	56/67/74	56/67/74	58/69/76	58/69/76
Sound power discharge	Lo/Med/Hi	dB(A)	56/65/74	56/65/74	56/65/74	58/67/76	58/67/76
Sound pressure ³⁾	Lo/Med/Hi	dB(A)	35/46/52	35/46/52	35/46/52	37/48/54	37/48/54
Fan							
Number			1	1	1	1	1
Air flow 2-pipe	Lo/Med/Hi	m ³ /sec	0.30/0.67/1.00	0.30/0.67/1.00	0.30/0.67/1.00	0.34/0.75/1.06	0.34/0.75/1.06
Air flow 4-pipe	Lo/Med/Hi	m ³ /sec	0.30/0.67/1.00	0.30/0.67/1.00	0.30/0.67/1.00	0.34/0.75/1.06	0.34/0.75/1.06
Maximum external pressure		Pa	300	300	300	300	300
Filter			G3	G3	G3	G3	G3
Electrical data							
Power supply	Voltage	V	230	230	230	230	230
	Phase		Single phase	Single phase	Single phase	Single phase	Single phase
	Frequency	Hz	50/60	50/60	50/60	50/60	50/60
Power consumption	Lo/Med/Hi	W	67/172/246	67/172/246	67/172/246	64/237/364	64/237/364
Water connections							
Type			Gas Male threaded	Gas Male threaded	Gas Male threaded	Gas Male threaded	Gas Male threaded
2-pipe	Inch		1	1 1/4	1 1/4	1 1/4	1 1/4
4-pipe	Cooling	Inch	1	1	1	1 1/4	1 1/4
	Heating	Inch	3/4	3/4	3/4	3/4	3/4
Dimensions and weight							
Dimension	HxWxD	mm	375 x 798 x 1380	375 x 798 x 1380	375 x 798 x 1380	450 x 798 x 1500	450 x 798 x 1500
Weight		kg	63	65	67	76	80
2-pipe RRP		€	1.015	1.110	1.174	1.295	1.380
4-pipe RRP		€	1.015	1.110	1.174	1.295	1.380

1) According to Eurovent standard. Air: 27 °C DB / 19 °C WB. Water in / out: 7 °C / 12 °C. 2) Air: 20 °C. Water in / out: 50 °C / 45 °C. 3) Informative data: Considering an hypothetical sound attenuation of the room and installation of 21 dB.

Values indicated are for 50 Pa external static pressure, for additional pressure characteristics, please refer the selection software.

Technical focus

- 5 sizes
- Cooling capacity from 6.6 to 19.9 kW
- Heating capacity from 5.9 to 21.4 kW
- Low energy consumption EC fan

Main features and accessories

- 2 and 4-pipe, left and right hand configurations
- Static pressure up to 300Pa
- Double skin insulation
- 2 way or 3 way ON / OFF valves
- Auxiliary drain pan
- Air intake with removable grid
- G3 filter

Operating limits

Entering water temperature	From 5 to 90 °C
Indoor air temperature	From 5 to 32 °C



Fan coils - 4 way cassette (AC)



Optional controller.
Wired remote controller.
PAW-FC-903TC



Optional controller.
Advanced wired remote controller.
PAW-FC-RC1

2-pipe			PAW-FC2A-U020-2	PAW-FC2A-U030-2	PAW-FC2A-U040-2	PAW-FC2A-U050-2	PAW-FC2A-U060-2	PAW-FC2A-U070-2
Total cooling capacity ¹⁾	Lo/Med/Hi	kW	1.5/1.8/2.4	1.9/2.7/4.0	2.8/3.5/4.7	3.4/4.4/6.1	3.7/5.4/7.2	4.0/6.5/8.6
Sensible cooling capacity ¹⁾	Lo/Med/Hi	kW	1.3/1.5/2.0	1.4/2.2/3.0	2.1/2.6/3.6	2.6/3.4/4.8	2.7/4.0/5.4	3.0/4.8/6.4
Water flow	Lo/Med/Hi	l/h	265/303/404	323/493/683	478/597/801	576/762/142	636/937/1233	695/1111/1476
Water pressure drop	Lo/Med/Hi	kPa	4.3/6.8/10.9	3.6/8.5/14.4	6.9/11.2/18.3	8.4/13.0/21.9	3.4/7.5/11.5	5.6/13.0/20.5
Heating capacity ²⁾	Lo/Med/Hi	kW	2.2/2.5/3.2	2.3/3.7/4.5	3.7/4.6/6.2	4.5/6.0/8.1	4.5/7.4/10.0	5.2/9.2/12.0
4-pipe			PAW-FC4A-U020-2	PAW-FC4A-U030-2	PAW-FC4A-U040-2	—	PAW-FC4A-U060-2	PAW-FC4A-U070-2
Total cooling capacity ¹⁾	Lo/Med/Hi	kW	1.4/1.5/2.0	2.0/2.7/3.4	2.5/3.3/4.0	—	3.0/4.9/6.6	3.2/6.0/7.5
Sensible cooling capacity ¹⁾	Lo/Med/Hi	kW	1.2/1.4/1.8	1.5/2.1/2.6	2.0/2.6/3.2	—	2.3/3.8/5.1	2.5/4.6/5.9
Water flow	Lo/Med/Hi	l/h	232/258/359	342/465/576	437/563/683	—	511/851/1137	543/1030/1294
Water pressure drop	Lo/Med/Hi	kPa	6.6/8.9/13.6	4.4/8.3/11.6	6.7/11.2/15.3	—	6.0/13.9/22.2	7.1/18.9/27.5
Heating capacity ²⁾	Lo/Med/Hi	kW	0.8/0.9/1.2	2.2/3.1/3.8	3.0/3.5/4.1	—	3.7/5.5/7.0	4.5/7.1/8.9
Water flow	Lo/Med/Hi	l/h	132/153/201	374/530/658	521/603/699	—	636/939/1210	776/1214/1540
Water pressure drop	Lo/Med/Hi	kPa	25.7/33.4/53.6	13.7/24.2/35	24.2/30.9/39.8	—	7.6/13.8/20.7	10.2/20.8/30.9
Sound levels								
Global sound power 2-pipe	Lo/Med/Hi	dB(A)	36/40/49	35/47/53	42/48/57	35/40/49	38/46/54	40/52/59
Global sound power 4-pipe	Lo/Med/Hi	dB(A)	36/40/49	35/47/53	42/48/57	—	38/46/54	40/52/59
Global sound pressure 2-pipe ³⁾	Lo/Med/Hi	dB(A)	27/31/40	26/35/44	33/39/48	26/31/40	29/37/45	31/43/50
Global sound pressure 4-pipe ³⁾	Lo/Med/Hi	dB(A)	27/31/40	26/35/44	33/39/48	—	29/37/45	31/43/50
Fan								
Number			1	1	1	1	1	1
Air flow	Lo/Med/Hi	m ³ /sec	0.10/0.13/0.18	0.09/0.14/0.20	0.14/0.17/0.25	0.15/0.20/0.27	0.14/0.23/0.32	0.17/0.30/0.40
Filter			G1	G1	G1	G1	G1	G1
Electrical data								
Power supply	Voltage	V	230	230	230	230	230	230
	Phase		Single phase	Single phase	Single phase	Single phase	Single phase	Single phase
	Frequency	Hz	50	50	50	50	50	50
Power consumption 2-pipe	Lo/Med/Hi	W	25/35/58	17/34/58	38/58/99	28/41/66	34/61/88	44/92/125
Power consumption 4-pipe	Lo/Med/Hi	W	25/35/58	17/34/58	38/58/99	—	34/61/88	44/92/125
Water connections								
Type			Female gas threaded	Female gas threaded	Female gas threaded	Female gas threaded	Female gas threaded	Female gas threaded
2-pipe		Inch	3/4	3/4	3/4	1	1	1
4-pipe	Cooling	Inch	3/4	3/4	3/4	—	1	1
	Heating	Inch	1/2	1/2	1/2	—	3/4	3/4
Dimensions and weight								
Dimension including panel	H x W x D	mm	334 x 720 x 720	334 x 720 x 720	334 x 720 x 720	339 x 960 x 960	339 x 960 x 960	339 x 960 x 960
Weight		kg	14.8	16.5	16.5	37.1	37.1	39.6
2-pipe RRP		£	670	725	762	1.222	1.252	1.302
4-pipe RRP		£	753	813	852	—	1.357	1.398
Panel model name			PAW-FC-KPY2040	PAW-FC-KPY2040	PAW-FC-KPY2040	PAW-FC-KPU5070	PAW-FC-KPU5070	PAW-FC-KPU5070
Panel RRP		£	160	160	160	225	225	225

1) According to Eurovent standard. Air: 27 °C DB / 19 °C WB. Water in / out: 7 °C / 12 °C. 2) According to Eurovent standard. Air: 20 °C. Water in / out: 45 °C / 40 °C. 3) Information data considering an hypothetical sound attenuation of the room and installation of -9 dB(A).

Technical focus

- 6 sizes*
- Cooling capacity from 1.4 to 8.6 kW
- Heating capacity from 1.1 to 12.8 kW
- 3-speed AC fan motor

Main features and accessories

- 2 and 4-pipe configurations
- Very low acoustic levels
- Quick access, by simply removing the front grille
- All connections: located at the same side
- Galvanized steel sheet with thermal and acoustical insulation, avoiding condensation on the casing and providing good sound attenuation
- Cleanable synthetic-type air filter

Operating limits	
Entering water temperature	From 5 to 90 °C
Indoor air temperature	From 5 to 32 °C

* 5 sizes available for 4-pipe configuration.



Fan coils - 4 way cassette (EC)



Optional controller.
Wired remote
controller for EC fans.
PAW-FC-907TC

2-pipe			PAW-FC2E-U020-2	PAW-FC2E-U030-2	PAW-FC2E-U040-2	PAW-FC2E-U050-2	PAW-FC2E-U060-2	PAW-FC2E-U070-2
Total cooling capacity ¹⁾	Lo/Med/Hi	kW	1.6/1.8/2.4	1.9/2.9/4.0	2.8/3.5/4.7	3.4/4.4/6.1	3.7/5.5/7.2	4.1/6.5/9.6
Sensible cooling capacity ¹⁾	Lo/Med/Hi	kW	1.3/1.5/2.0	1.4/2.2/3.1	2.1/2.7/3.6	2.6/3.5/4.7	2.7/4.1/5.4	3.0/4.9/7.2
Water flow	Lo/Med/Hi	l/h	267/306/409	325/497/688	481/604/808	579/765/1050	640/944/1243	700/1119/1649
Water pressure drop	Lo/Med/Hi	kPa	4.2/6.9/11.2	3.5/8.6/14.6	6.8/11.4/18.6	8.4/13.1/22.2	3.4/7.6/11.7	5.8/13.1/24.6
Heating capacity ²⁾	Lo/Med/Hi	kW	2.2/2.5/3.2	2.3/3.7/4.5	3.7/4.6/6.2	4.5/6.0/8.1	4.5/7.4/10.0	5.2/9.2/13.0
4-pipe			PAW-FC4E-U020-2	PAW-FC4E-U030-2	PAW-FC4E-U040-2	—	PAW-FC4E-U060-2	PAW-FC4E-U070-2
Total cooling capacity ¹⁾	Lo/Med/Hi	kW	1.4/1.5/2.0	2.0/2.7/3.4	2.6/3.2/4.0	—	3.0/5.0/6.6	3.2/6.1/7.9
Sensible cooling capacity ¹⁾	Lo/Med/Hi	kW	1.2/1.4/1.9	1.5/2.1/2.6	2.1/2.6/3.3	—	2.3/3.8/5.1	2.6/4.7/6.3
Water flow	Lo/Med/Hi	l/h	234/262/344	344/464/581	442/556/690	—	516/858/1144	549/1041/1366
Water pressure drop	Lo/Med/Hi	kPa	6.6/9.1/14.0	4.4/8.2/11.7	6.7/10.9/15.5	—	6.0/14.1/22.4	7.2/19.2/30.1
Heating capacity ²⁾	Lo/Med/Hi	kW	0.8/0.9/1.2	2.2/3.1/3.8	3.0/3.5/4.1	—	3.7/5.5/7.0	4.5/7.1/9.8
Water flow	Lo/Med/Hi	l/h	132/153/201	374/530/658	521/603/699	—	636/939/1210	776/1214/1686
Water pressure drop	Lo/Med/Hi	kPa	25.7/33.4/53.6	13.7/24.2/35	24.2/30.9/39.8	—	7.6/13.8/20.7	10.2/20.8/36
Sound levels								
Global sound power 2-pipe	Lo/Med/Hi	dB(A)	36/40/49	35/47/53	42/48/57	35/40/49	38/46/54	40/52/59
Global sound power 4-pipe	Lo/Med/Hi	dB(A)	36/40/49	35/44/53	42/48/57	—	38/46/54	40/52/59
Global sound pressure 2-pipe ³⁾	Lo/Med/Hi	dB(A)	27/31/40	26/35/44	33/39/48	26/31/40	29/37/45	31/43/50
Global sound pressure 4-pipe ³⁾	Lo/Med/Hi	dB(A)	27/31/40	26/35/44	33/39/48	—	29/37/45	31/43/50
Fan								
Number			1	1	1	1	1	1
Air flow	Lo/Med/Hi	m ³ /sec	0.10/0.13/0.18	0.09/0.14/0.20	0.14/0.17/0.25	0.15/0.20/0.27	0.14/0.23/0.32	0.17/0.30/0.44
Filter			G1	G1	G1	G1	G1	G1
Electrical data								
Power supply	Voltage	V	230	230	230	230	230	230
	Phase		Single phase	Single phase	Single phase	Single phase	Single phase	Single phase
	Frequency	Hz	50	50	50	50	50	50
Power consumption 2-pipe	Lo/Med/Hi	W	9/13/29	7/14/32	13/22/57	7/12/25	9/23/25	11/40/115
Power consumption 4-pipe	Lo/Med/Hi	W	9/13/29	7/14/32	13/22/57	—	9/23/46	11/40/115
Water connections								
Type			Female gas threaded	Female gas threaded	Female gas threaded	Female gas threaded	Female gas threaded	Female gas threaded
2-pipe	Inch		3/4	3/4	3/4	1	1	1
4-pipe	Cooling	Inch	3/4	3/4	3/4	—	1	1
	Heating	Inch	1/2	1/2	1/2	—	3/4	3/4
Dimensions and weight								
Dimension including panel	HxWxD	mm	334x720x720	334x720x720	334x720x720	339x960x960	339x960x960	339x960x960
Weight		kg	14.8	16.5	16.5	37.1	37.1	39.6
2-pipe RRP	£		813	869	907	1.289	1.452	1.502
4-pipe RRP	£		890	942	981	—	1.565	1.583
Panel model name			PAW-FC-KPY2040	PAW-FC-KPY2040	PAW-FC-KPY2040	PAW-FC-KPU5070	PAW-FC-KPU5070	PAW-FC-KPU5070
Panel RRP	£		160	160	160	225	225	225

1) According to Eurovent standard. Air: 27 °C DB / 19 °C WB. Water in / out: 7 °C / 12 °C. 2) According to Eurovent standard. Air: 20 °C. Water in / out: 45 °C / 40 °C. 3) Information data considering an hypothetical sound attenuation of the room and installation of -9 dB(A).

Technical focus

- 6 sizes*
- Cooling capacity from 1.4 to 9.4 kW
- Heating capacity from 1.1 to 14.0 kW
- Low energy consumption EC fan

Main features and accessories

- 2 and 4-pipe configurations
- Very low acoustic levels
- Quick access, by simply removing the front grille
- All connections: located at the same side
- Galvanized steel sheet with thermal and acoustical insulation, avoiding condensation on the casing and providing good sound attenuation
- Cleanable synthetic-type air filter

Operating limits

Entering water temperature	From 5 to 90 °C
Indoor air temperature	From 5 to 32 °C

* 5 sizes available for 4-pipe configuration.



Fan coils - ceiling chassis (AC)



Optional controller.
Wired remote controller.
PAW-FC-903TC



Optional controller.
Advanced wired remote controller.
PAW-FC-RC1

2-pipe - Left connection (PAW-)		FC2A-T010L	FC2A-T020L	FC2A-T030L	FC2A-T040L	FC2A-T050L	FC2A-T060L	FC2A-T070L	FC2A-T080L	
2-pipe - Right connection (PAW-)		FC2A-T010R	FC2A-T020R	FC2A-T030R	FC2A-T040R	FC2A-T050R	FC2A-T060R	FC2A-T070R	FC2A-T080R	
Total cooling capacity ¹⁾	Lo/Med/Hi kW	0.7/1.0/1.5	0.7/1.2/1.7	1.0/2.0/2.5	1.2/2.4/3.2	1.7/3.2/4.6	2.7/4.6/5.8	3.4/6.1/7.3	4.6/6.1/8.1	
Sensible cooling capacity ¹⁾	Lo/Med/Hi kW	0.5/0.8/1.1	0.6/0.9/1.3	0.8/1.5/1.9	0.9/1.8/2.3	1.2/2.2/3.3	1.9/3.3/4.5	2.4/4.3/5.1	3.4/4.6/6.3	
Water flow	Lo/Med/Hi l/h	124/172/250	127/213/289	172/341/430	206/413/547	296/544/798	466/784/1003	587/1058/1252	798/1048/1400	
Water pressure drop	Lo/Med/Hi kPa	10.7/19.5/39.2	1.9/3.9/6.3	6.3/19.3/28.8	5.4/17.1/28.0	7.5/22.8/46.9	13.9/37.4/60.2	4.8/15.4/21.5	11.9/19.3/32.5	
Heating capacity ²⁾	Lo/Med/Hi kW	0.9/1.4/2.0	0.9/1.5/2.2	1.3/2.4/3.1	1.4/2.9/4.0	2.1/4.1/5.7	3.1/5.3/7.1	4.3/7.9/9.3	5.9/8.1/11.6	
4-pipe - Left connection (PAW-)		FC4A-T010L	FC4A-T020L	FC4A-T030L	FC4A-T040L	FC4A-T050L	FC4A-T060L	FC4A-T070L	FC4A-T080L	
4-pipe - Right connection (PAW-)		FC4A-T010R	FC4A-T020R	FC4A-T030R	FC4A-T040R	FC4A-T050R	FC4A-T060R	FC4A-T070R	FC4A-T080R	
Total cooling capacity ¹⁾	Lo/Med/Hi kW	0.7/0.9/1.3	0.6/1.1/1.6	1.0/1.9/2.4	1.1/2.3/3.0	1.7/3.0/4.3	2.6/4.4/5.6	3.3/5.9/6.9	4.5/5.9/8.0	
Sensible cooling capacity ¹⁾	Lo/Med/Hi kW	0.5/0.7/1.0	0.5/0.8/1.2	0.8/1.5/1.8	0.8/1.7/2.2	1.2/2.2/3.1	1.8/3.2/4.3	2.3/4.2/4.9	3.3/4.4/6.2	
Water flow	Lo/Med/Hi l/h	114/159/225	109/192/268	165/327/414	194/388/517	284/522/748	449/756/967	575/1019/1193	775/1020/1380	
Water pressure drop	Lo/Med/Hi kPa	8.3/15.2/29.0	1.5/3.4/5.6	3.0/9.5/14.4	6.4/22.3/36.8	4.2/12.8/25.1	10.2/27.7/44.5	5.9/17.9/24.4	19.3/31.1/53.6	
Heating capacity ²⁾	Lo/Med/Hi kW	0.5/0.7/1.0	0.6/0.9/1.1	1.0/1.4/1.6	0.9/1.6/2.1	1.5/2.3/3.0	1.9/2.9/3.7	2.7/3.6/4.3	3.9/5.6/7.1	
Water flow	Lo/Med/Hi l/h	79/127/178	100/146/190	164/232/274	160/273/354	251/401/508	325/505/633	456/626/736	673/963/1226	
Water pressure drop	Lo/Med/Hi kPa	1.9/3.5/5.6	1.5/3.2/5.3	5.1/9.0/11.9	9.2/26.5/42.7	10.7/24.6/29.5	20.3/43.9/52.9	67.2/117.9/137.8	33.1/63.7/75	
Sound levels										
Global sound power	Lo/Med/Hi dB(A)	33/40/49	31/43/50	30/45/52	30/44/51	34/46/56	38/51/58	43/56/61	50/55/64	
Global sound pressure ³⁾	Lo/Med/Hi dB(A)	24/31/40	22/34/41	21/36/43	21/35/42	25/37/47	29/42/49	34/47/52	41/46/55	
Fan										
Number		1	1	1	2	2	2	2	3	
Air flow 2-pipe	Lo/Med/Hi m ³ /sec	0.03/0.05/0.08	0.03/0.05/0.07	0.04/0.08/0.11	0.05/0.10/0.14	0.07/0.14/0.20	0.10/0.18/0.26	0.13/0.25/0.30	0.18/0.26/0.39	
Air flow 4-pipe	Lo/Med/Hi m ³ /sec	0.03/0.05/0.07	0.02/0.04/0.07	0.04/0.07/0.10	0.05/0.09/0.13	0.07/0.13/0.19	0.09/0.17/0.25	0.13/0.24/0.28	0.18/0.25/0.38	
Filter		G2	G2	G2	G2	G2	G2	G2	G2	
Electrical data										
Power supply	Voltage	V	230	230	230	230	230	230	230	
	Phase		Single phase	Single phase	Single phase	Single phase	Single phase	Single phase	Single phase	
	Frequency	Hz	50/60	50/60	50/60	50/60	50/60	50/60	50/60	
Power consumption 2-pipe	Lo/Med/Hi W	13/24/36	10/18/29	16/37/45	15/37/56	28/55/72	37/75/105	53/100/147	90/112/188	
Power consumption 4-pipe	Lo/Med/Hi W	13/24/36	10/18/28	16/37/44	15/37/55	28/54/70	37/74/104	53/99/145	90/112/188	
Water connections										
Type		Female gas threaded	Female gas threaded	Female gas threaded	Female gas threaded	Female gas threaded	Female gas threaded	Female gas threaded	Female gas threaded	
2-pipe	Inch	1/2	1/2	1/2	1/2	1/2	1/2	3/4	3/4	
4-pipe	Cooling	Inch	1/2	1/2	1/2	1/2	1/2	3/4	3/4	
	Heating	Inch	1/2	1/2	1/2	1/2	1/2	1/2	1/2	
Dimensions and weight										
Dimension	HxWxD	mm	225 x 766 x 477	225 x 766 x 477	225 x 951 x 477	225 x 1136 x 477	225 x 1321 x 477	225 x 1506 x 477	225 x 1319 x 477	225 x 1506 x 477
Weight	2 / 4-pipes	kg	19/20	19/20	22/23	27/29	30/32	35/37	35/37	47/49
2-pipe RRP		£	468	482	506	568	616	658	720	961
4-pipe RRP		£	497	501	528	595	647	694	762	1.012

1) According to Eurovent standard. Air: 27 °C DB / 19 °C WB. Water in / out: 7 °C / 12 °C. 2) Air: 20 °C. Water in / out: 50 °C / 45 °C. 3) The sound pressure levels are based on (NR) characteristics of a room having volume of 100 m³ with reverberation of 0.5 seconds.

Technical focus

- Cooling capacity from 0.7 to 8.1 kW
- Heating capacity from 0.7 to 10.3 kW
- 5-speed AC fan motor(s)

Main features and accessories

- 2 and 4-pipe configurations
- Left or right hand arrangements
- Ease of installation
- Very low acoustic levels
- 2 way or 3 way ON / OFF valves
- Auxiliary drain pan
- Air intake with removable grid
- G2 filter

Operating limits	
Entering water temperature	From 5 to 90 °C
Indoor air temperature	From 5 to 32 °C



Fan coils - ceiling chassis (EC)



Optional controller.
Wired remote
controller for EC fans.
PAW-FC-907TC

2-pipe - Left connection (PAW-)		FC2E-T010L	FC2E-T020L	FC2E-T030L	FC2E-T040L	FC2E-T050L	FC2E-T060L	FC2E-T070L	FC2E-T080L	
2-pipe - Right connection (PAW-)		FC2E-T010R	FC2E-T020R	FC2E-T030R	FC2E-T040R	FC2E-T050R	FC2E-T060R	FC2E-T070R	FC2E-T080R	
Total cooling capacity ¹⁾	Lo/Med/Hi kW	0.6/1.2/2.1	0.6/1.4/2.4	0.9/2.1/3.1	1.3/2.9/4.2	1.3/4.0/5.0	2.0/4.5/5.2	2.7/5.9/6.9	5.1/6.5/8.8	
Sensible cooling capacity ¹⁾	Lo/Med/Hi kW	0.5/1.1/1.9	0.5/1.1/1.9	0.6/1.6/2.4	1.0/2.1/3.0	1.1/3.0/3.7	1.4/3.5/4.0	2.0/4.3/5.2	3.7/4.8/6.6	
Water flow	Lo/Med/Hi l/h	107/210/356	110/237/406	148/354/532	230/506/722	231/685/743	341/767/800	463/1008/1098	879/1111/1254	
Water pressure drop	Lo/Med/Hi kPa	8.2/28.2/76.9	1.5/4.6/11.0	5.0/20.5/42.1	6.4/24.4/46.3	4.9/35.1/41.0	7.8/35.8/38.8	3.0/14.0/16.6	14.1/21.4/26.6	
Heating capacity ²⁾	Lo/Med/Hi kW	0.8/1.6/2.9	0.9/1.9/3.3	1.0/2.2/3.4	1.4/3.0/5.3	1.7/5.2/5.5	2.3/5.9/6.1	3.8/7.3/8.2	6.2/8.0/9.3	
4-pipe - Left connection (PAW-)		FC4E-T010L	FC4E-T020L	FC4E-T030L	FC4E-T040L	FC4E-T050L	FC4E-T060L	FC4E-T070L	FC4E-T080L	
4-pipe - Right connection (PAW-)		FC4E-T010R	FC4E-T020R	FC4E-T030R	FC4E-T040R	FC4E-T050R	FC4E-T060R	FC4E-T070R	FC4E-T080R	
Total cooling capacity ¹⁾	Lo/Med/Hi kW	0.5/1.1/1.9	0.6/1.2/2.2	0.8/1.9/2.9	1.2/2.7/4.0	1.2/3.6/4.6	1.8/4.1/4.9	2.6/5.1/6.4	5.0/6.2/9.6	
Sensible cooling capacity ¹⁾	Lo/Med/Hi kW	0.4/0.9/1.7	0.4/1.0/1.8	0.6/1.5/2.2	0.9/1.9/2.8	1.0/2.8/3.5	1.2/3.2/3.8	1.9/3.8/4.8	3.6/4.6/7.2	
Water flow	Lo/Med/Hi l/h	92/185/327	97/206/375	129/321/493	205/457/681	212/625/686	306/707/749	443/886/977	855/1070/1242	
Water pressure drop	Lo/Med/Hi kPa	5.8/20.1/59.2	1.3/3.7/9.7	4.0/9.2/19.7	6.3/29.6/60.1	2.5/17.9/21.3	5.1/24.3/27.2	3.5/13.6/16.5	22.9/33.9/44.3	
Heating capacity ²⁾	Lo/Med/Hi kW	0.4/0.8/1.4	0.6/0.9/1.5	1.0/1.4/1.8	1.2/2.0/2.8	1.6/2.4/2.5	1.4/2.9/3.1	2.5/3.4/3.6	4.5/5.9/6.9	
Water flow	Lo/Med/Hi l/h	76/140/235	95/161/255	166/243/304	204/350/483	267/416/438	233/503/531	434/583/614	767/1011/1194	
Water pressure drop	Lo/Med/Hi kPa	1.8/4.0/8.4	1.4/3.8/9.4	5.3/9.7/14.1	15.6/41.8/76.3	11.9/26.3/28.9	11.5/43.6/48.1	61.5/103.8/113.9	42.1/69.7/95.1	
Sound levels										
Global sound power	Lo/Med/Hi dB[A]	34/47/60	34/47/60	31/50/59	29/44/52	30/51/57	32/54/58	40/54/59	51/56/64	
Global sound pressure ³⁾	Lo/Med/Hi dB[A]	25/38/51	25/38/51	22/41/50	20/35/43	21/42/48	23/45/49	31/45/50	42/47/55	
Fan										
Number		1	1	1	2	2	2	2	3	
Air flow 2-pipe	Lo/Med/Hi m ³ /sec	0.03/0.06/0.12	0.03/0.07/0.11	0.04/0.11/0.16	0.05/0.11/0.19	0.06/0.18/0.23	0.07/0.20/0.25	0.10/0.24/0.29	0.19/0.26/0.39	
Air flow 4-pipe	Lo/Med/Hi m ³ /sec	0.03/0.06/0.11	0.02/0.06/0.11	0.03/0.10/0.15	0.04/0.10/0.17	0.05/0.16/0.18	0.06/0.19/0.20	0.09/0.22/0.25	0.18/0.25/0.30	
Filter		G2	G2	G2	G2	G2	G2	G2	G2	
Electrical data										
Power supply	Voltage	V	230	230	230	230	230	230	230	
	Phase		Single phase	Single phase	Single phase	Single phase	Single phase	Single phase	Single phase	
	Frequency	Hz	50/60	50/60	50/60	50/60	50/60	50/60	50/60	
Power consumption 2-pipe	Lo/Med/Hi W	5/11/41	5/13/41	4/16/42	2/13/43	4/24/46	2/30/54	11/44/77	23/42/108	
Power consumption 4-pipe	Lo/Med/Hi W	5/11/39	5/13/40	6/15/40	2/12/42	2/23/44	2/28/52	11/43/75	22/41/116	
Water connections										
Type		Female gas threaded	Female gas threaded	Female gas threaded	Female gas threaded	Female gas threaded	Female gas threaded	Female gas threaded	Female gas threaded	
2-pipe	Inch	1/2	1/2	1/2	1/2	1/2	1/2	3/4	3/4	
4-pipe	Cooling	Inch	1/2	1/2	1/2	1/2	1/2	3/4	3/4	
	Heating	Inch	1/2	1/2	1/2	1/2	1/2	1/2	1/2	
Dimensions and weight										
Dimension	HxWxD	mm	225 x 766 x 477	225 x 766 x 477	225 x 951 x 477	225 x 1136 x 477	225 x 1321 x 477	225 x 1506 x 477	225 x 1319 x 477	225 x 1506 x 477
Weight	2 / 4-pipes	kg	19/20	19/20	22/23	27/29	30/32	35/37	35/37	47/49
2-pipe RRP	£		635	648	674	736	784	825	892	1.132
4-pipe RRP	£		664	668	696	763	815	860	932	1.183

1) According to Eurovent standard. Air: 27 °C DB / 19 °C WB. Water in / out: 7 °C / 12 °C. 2) Air: 20 °C. Water in / out: 50 °C / 45 °C. 3) The sound pressure levels are based on (NR) characteristics of a room having volume of 100 m³ with reverberation of 0.5 seconds.

Technical focus

- Cooling capacity from 0.5 to 9.6 kW
- Heating capacity from 0.6 to 13.6 kW
- Low energy consumption EC fan[s]

Main features and accessories

- 2 and 4-pipe configurations
- Left or right hand arrangements
- Ease of installation
- Very low acoustic levels
- 2 way or 3 way ON / OFF valves
- Auxiliary drain pan
- Air intake with removable grid
- G2 filter

Operating limits

Entering water temperature	From 5 to 90 °C
Indoor air temperature	From 5 to 32 °C





Fan coils - floor-standing chassis (AC)



Optional controller.
Wired remote controller.
PAW-FC-903TC



Optional controller.
Advanced wired remote controller.
PAW-FC-RC1

2-pipe - Left connection (PAW-)			FC2A-P010L	FC2A-P020L	FC2A-P030L	FC2A-P040L	FC2A-P050L	FC2A-P060L	FC2A-P070L	FC2A-P080L
2-pipe - Right connection (PAW-)			FC2A-P010R	FC2A-P020R	FC2A-P030R	FC2A-P040R	FC2A-P050R	FC2A-P060R	FC2A-P070R	FC2A-P080R
Total cooling capacity ¹⁾	Lo/Med/Hi	kW	0.7/1.0/1.5	0.7/1.2/1.7	1.0/2.0/2.5	1.2/2.4/3.2	1.7/3.2/4.6	2.7/4.6/5.8	3.4/6.1/7.3	4.6/6.1/8.1
Sensible cooling capacity ¹⁾	Lo/Med/Hi	kW	0.5/0.8/1.1	0.6/0.9/1.3	0.8/1.5/1.9	0.9/1.8/2.3	1.2/2.2/3.3	1.9/3.3/4.5	2.4/4.3/5.1	3.4/4.6/6.3
Water flow	Lo/Med/Hi	l/h	124/172/250	127/213/289	172/341/430	206/413/547	296/544/798	466/784/1003	587/1058/1252	798/1048/1400
Water pressure drop	Lo/Med/Hi	kPa	10.7/19.5/39.2	1.9/3.9/6.3	6.3/19.3/28.8	5.4/17.1/28.0	7.5/22.8/46.9	13.9/37.4/60.2	4.8/15.4/21.5	11.9/19.3/32.5
Heating capacity ²⁾	Lo/Med/Hi	kW	0.9/1.4/2.0	0.9/1.5/2.2	1.3/2.4/3.1	1.4/2.9/4.0	2.1/4.1/5.7	3.1/5.3/7.1	4.3/7.9/9.3	5.9/8.1/11.6
4-pipe - Left connection (PAW-)			FC4A-P010L	FC4A-P020L	FC4A-P030L	FC4A-P040L	FC4A-P050L	FC4A-P060L	FC4A-P070L	FC4A-P080L
4-pipe - Right connection (PAW-)			FC4A-P010R	FC4A-P020R	FC4A-P030R	FC4A-P040R	FC4A-P050R	FC4A-P060R	FC4A-P070R	FC4A-P080R
Total cooling capacity ¹⁾	Lo/Med/Hi	kW	0.7/0.9/1.3	0.6/1.1/1.6	1.0/1.9/2.4	1.1/2.3/3.0	1.7/3.0/4.3	2.6/4.4/5.6	3.3/5.9/6.9	4.5/5.9/8.0
Sensible cooling capacity ¹⁾	Lo/Med/Hi	kW	0.5/0.7/1.0	0.5/0.8/1.2	0.8/1.5/1.8	0.8/1.7/2.2	1.2/2.2/3.1	1.8/3.2/4.3	2.3/4.2/4.9	3.3/4.4/6.2
Water flow	Lo/Med/Hi	l/h	114/159/225	109/192/268	165/327/414	194/388/517	284/522/748	449/756/967	575/1019/1193	775/1020/1380
Water pressure drop	Lo/Med/Hi	kPa	8.3/15.2/29.0	1.5/3.4/5.6	3.0/9.5/14.4	6.4/22.3/36.8	4.2/12.8/25.1	10.2/27.7/44.5	5.9/17.9/24.4	19.3/31.1/53.6
Heating capacity ²⁾	Lo/Med/Hi	kW	0.5/0.7/1.0	0.6/0.9/1.1	1.0/1.4/1.6	0.9/1.6/2.1	1.5/2.3/3.0	1.9/2.9/3.7	2.7/3.6/4.3	3.9/5.6/7.1
Water flow	Lo/Med/Hi	l/h	79/127/178	100/146/190	164/232/274	160/273/354	251/401/508	325/505/633	456/626/736	673/963/1226
Water pressure drop	Lo/Med/Hi	kPa	1.9/3.5/5.6	1.5/3.2/5.3	5.1/9.0/11.9	9.2/26.5/42.7	10.7/24.6/29.5	20.3/43.9/52.9	67.2/117.9/137.8	33.1/63.7/75
Sound levels										
Global sound power	Lo/Med/Hi	dB[A]	33/40/49	31/43/50	30/45/52	30/44/51	34/46/56	38/51/58	43/56/61	50/55/64
Global sound pressure ³⁾	Lo/Med/Hi	dB[A]	24/31/40	22/34/41	21/36/43	21/35/42	25/37/47	29/42/49	34/47/52	41/46/55
Fan										
Number			1	1	1	2	2	2	2	3
Air flow 2-pipe	Lo/Med/Hi	m ³ /sec	0.03/0.05/0.08	0.03/0.05/0.07	0.04/0.08/0.11	0.05/0.10/0.14	0.07/0.14/0.20	0.10/0.18/0.26	0.13/0.25/0.30	0.18/0.26/0.39
Air flow 4-pipe	Lo/Med/Hi	m ³ /sec	0.03/0.05/0.07	0.02/0.04/0.07	0.04/0.07/0.10	0.05/0.09/0.13	0.07/0.13/0.19	0.09/0.17/0.25	0.13/0.24/0.28	0.18/0.25/0.38
Filter			G2	G2	G2	G2	G2	G2	G2	G2
Electrical data										
Power supply	Voltage	V	230	230	230	230	230	230	230	230
	Phase		Single phase	Single phase	Single phase	Single phase	Single phase	Single phase	Single phase	Single phase
	Frequency	Hz	50/60	50/60	50/60	50/60	50/60	50/60	50/60	50/60
Power consumption 2-pipe	Lo/Med/Hi	W	13/24/36	10/18/29	16/37/45	15/37/56	28/55/72	37/75/105	53/100/147	90/112/188
Power consumption 4-pipe	Lo/Med/Hi	W	13/24/36	10/18/28	16/37/44	15/37/55	28/54/70	37/74/104	53/99/145	90/112/188
Water connections										
Type			Female gas threaded	Female gas threaded	Female gas threaded	Female gas threaded	Female gas threaded	Female gas threaded	Female gas threaded	Female gas threaded
2-pipe		Inch	1/2	1/2	1/2	1/2	1/2	1/2	3/4	3/4
	Cooling	Inch	1/2	1/2	1/2	1/2	1/2	1/2	3/4	3/4
4-pipe	Heating	Inch	1/2	1/2	1/2	1/2	1/2	1/2	1/2	1/2
Dimensions and weight										
Dimension ⁴⁾	HxWxD	mm	477 x 225 x 766	766 x 225 x 477	477 x 225 x 951	477 x 225 x 1136	477 x 225 x 1321	477 x 225 x 1506	575 x 225 x 1319	575 x 225 x 1506
Weight	2 / 4-pipes	kg	19/20	19/20	22/23	27/29	30/32	35/37	35/37	47/49
2-pipe RRP		£	327	342	366	428	477	518	580	820
4-pipe RRP		£	356	361	388	455	506	553	622	871

1) According to Eurovent standard. Air: 27 °C DB / 19 °C WB. Water in / out: 7 °C / 12 °C. 2) Air: 20 °C. Water in / out: 50 °C / 45 °C. 3) The sound pressure levels are based on (NR) characteristics of a room having volume of 100 m³ with reverberation of 0.5 seconds. 4) Without support feet.

Technical focus

- Cooling capacity from 0.7 to 8.1 kW
- Heating capacity from 0.7 to 10.3 kW
- 5-speed AC fan motor(s)

Main features and accessories

- 2 and 4-pipe configurations
- Left or right hand arrangements
- Ease of installation
- Very low acoustic levels
- 2 way or 3 way ON / OFF valves
- Auxiliary drain pan
- Air intake with removable grid
- G2 filter
- PAW-FC-SFS feet for floor-standing units

Operating limits

Entering water temperature	From 5 to 90 °C
Indoor air temperature	From 5 to 32 °C





Fan coils - floor-standing chassis (EC)



Optional controller.
Wired remote
controller for EC fans.
PAW-FC-907TC

2-pipe - Left connection (PAW-)		FC2E-P010L	FC2E-P020L	FC2E-P030L	FC2E-P040L	FC2E-P050L	FC2E-P060L	FC2E-P070L	FC2E-P080L	
2-pipe - Right connection (PAW-)		FC2E-P010R	FC2E-P020R	FC2E-P030R	FC2E-P040R	FC2E-P050R	FC2E-P060R	FC2E-P070R	FC2E-P080R	
Total cooling capacity ¹⁾	Lo/Med/Hi kW	0.6/1.2/2.1	0.6/1.4/2.4	0.9/2.1/3.1	1.3/2.9/4.2	1.3/4.0/5.0	2.0/4.5/5.2	2.7/5.9/6.9	5.1/6.5/8.8	
Sensible cooling capacity ¹⁾	Lo/Med/Hi kW	0.5/1.1/1.9	0.5/1.1/1.9	0.6/1.6/2.4	1.0/2.1/3.0	1.1/3.0/3.7	1.4/3.5/4.0	2.0/4.3/5.2	3.7/4.8/6.6	
Water flow	Lo/Med/Hi l/h	107/210/356	110/237/406	148/354/532	230/506/722	231/685/743	341/767/800	463/1008/1098	879/1111/1254	
Water pressure drop	Lo/Med/Hi kPa	8.2/28.2/76.9	1.5/4.6/11.0	5.0/20.5/42.1	6.4/24.4/46.3	4.9/35.1/41.0	7.8/35.8/38.8	3.0/14.0/16.6	14.1/21.4/26.6	
Heating capacity ²⁾	Lo/Med/Hi kW	0.8/1.6/2.9	0.9/1.9/3.3	1.0/2.2/3.4	1.4/3.0/5.3	1.7/5.2/5.5	2.3/5.9/6.1	3.8/7.3/8.2	6.2/8.0/9.3	
4-pipe - Left connection (PAW-)		FC4E-P010L	FC4E-P020L	FC4E-P030L	FC4E-P040L	FC4E-P050L	FC4E-P060L	FC4E-P070L	FC4E-P080L	
4-pipe - Right connection (PAW-)		FC4E-P010R	FC4E-P020R	FC4E-P030R	FC4E-P040R	FC4E-P050R	FC4E-P060R	FC4E-P070R	FC4E-P080R	
Total cooling capacity ¹⁾	Lo/Med/Hi kW	0.5/1.1/1.9	0.6/1.2/2.2	0.8/1.9/2.9	1.2/2.7/4.0	1.2/3.6/4.6	1.8/4.1/4.9	2.6/5.1/6.4	5.0/6.2/9.6	
Sensible cooling capacity ¹⁾	Lo/Med/Hi kW	0.4/0.9/1.7	0.4/1.0/1.8	0.6/1.5/2.2	0.9/1.9/2.8	1.0/2.8/3.5	1.2/3.2/3.8	1.9/3.8/4.8	3.6/4.6/7.2	
Water flow	Lo/Med/Hi l/h	92/185/327	97/206/375	129/321/493	205/457/681	212/625/686	306/707/749	443/886/977	855/1070/1242	
Water pressure drop	Lo/Med/Hi kPa	5.8/20.1/59.2	1.3/3.7/9.7	4.0/9.2/19.7	6.3/29.6/60.1	2.5/17.9/21.3	5.1/24.3/27.2	3.5/13.6/16.5	22.9/33.9/44.3	
Heating capacity ²⁾	Lo/Med/Hi kW	0.4/0.8/1.4	0.6/0.9/1.5	1.0/1.4/1.8	1.2/2.0/2.8	1.6/2.4/2.5	1.4/2.9/3.1	2.5/3.4/3.6	4.5/5.9/6.9	
Water flow	Lo/Med/Hi l/h	76/140/235	95/161/255	166/243/304	204/350/483	267/416/438	233/503/531	434/583/614	767/1011/1194	
Water pressure drop	Lo/Med/Hi kPa	1.8/4.0/8.4	1.4/3.8/9.4	5.3/9.7/14.1	15.6/41.8/76.3	11.9/26.3/28.9	11.5/43.6/48.1	61.5/103.8/113.9	42.1/69.7/95.1	
Sound levels										
Global sound power	Lo/Med/Hi dB[A]	34/47/60	34/47/60	31/50/59	29/44/52	30/51/57	32/54/58	40/54/59	51/56/64	
Global sound pressure ³⁾	Lo/Med/Hi dB[A]	25/38/51	25/38/51	22/41/50	20/35/43	21/42/48	23/45/49	31/45/50	42/47/55	
Fan										
Number		1	1	1	2	2	2	2	3	
Air flow 2-pipe	Lo/Med/Hi m ³ /sec	0.03/0.06/0.12	0.03/0.07/0.11	0.04/0.11/0.16	0.05/0.11/0.19	0.06/0.18/0.23	0.07/0.20/0.25	0.10/0.24/0.29	0.19/0.26/0.39	
Air flow 4-pipe	Lo/Med/Hi m ³ /sec	0.03/0.06/0.11	0.02/0.06/0.11	0.03/0.10/0.15	0.04/0.10/0.17	0.05/0.16/0.18	0.06/0.19/0.20	0.09/0.22/0.25	0.18/0.25/0.30	
Filter		G2	G2	G2	G2	G2	G2	G2	G2	
Electrical data										
Power supply	Voltage	V	230	230	230	230	230	230	230	
	Phase		Single phase	Single phase	Single phase	Single phase	Single phase	Single phase	Single phase	
	Frequency	Hz	50/60	50/60	50/60	50/60	50/60	50/60	50/60	
Power consumption 2-pipe	Lo/Med/Hi W	5/11/41	5/13/41	4/16/42	2/13/43	4/24/46	2/30/54	11/44/77	23/42/108	
Power consumption 4-pipe	Lo/Med/Hi W	5/11/39	5/13/40	6/15/40	2/12/42	2/23/44	2/28/52	11/43/75	22/41/116	
Water connections										
Type		Female gas threaded	Female gas threaded	Female gas threaded	Female gas threaded	Female gas threaded	Female gas threaded	Female gas threaded	Female gas threaded	
2-pipe	Inch	1/2	1/2	1/2	1/2	1/2	1/2	3/4	3/4	
4-pipe	Cooling	Inch	1/2	1/2	1/2	1/2	1/2	3/4	3/4	
	Heating	Inch	1/2	1/2	1/2	1/2	1/2	1/2	1/2	
Dimensions and weight										
Dimension ⁴⁾	HxWxD	mm	477 x 225 x 766	766 x 225 x 477	477 x 225 x 951	477 x 225 x 1136	477 x 225 x 1321	477 x 225 x 1506	575 x 225 x 1319	575 x 225 x 1506
Weight	2 / 4-pipes	kg	19/20	19/20	22/23	27/29	30/32	35/37	35/37	47/49
2-pipe RRP	£		496	508	533	595	643	684	751	991
4-pipe RRP	£		523	528	556	622	674	719	791	1.041

1) According to Eurovent standard. Air: 27 °C DB / 19 °C WB. Water in / out: 7 °C / 12 °C. 2) Air: 20 °C. Water in / out: 50 °C / 45 °C. 3) The sound pressure levels are based on (NR) characteristics of a room having volume of 100 m³ with reverberation of 0.5 seconds. 4) Without support feet.

Technical focus

- Cooling capacity from 0.5 to 9.6 kW
- Heating capacity from 0.6 to 13.6 kW
- Low energy consumption EC fan(s)

Main features and accessories

- 2 and 4-pipe configurations
- Left or right hand arrangements
- Ease of installation
- Very low acoustic levels
- 2 way or 3 way ON / OFF valves
- Auxiliary drain pan
- Air intake with removable grid
- G2 filter
- PAW-FC-SFS feet for floor-standing units

Operating limits

Entering water temperature	From 5 to 90 °C
Indoor air temperature	From 5 to 32 °C



Fan coils - wall-mounted (AC)



Optional controller.
Wired remote
controller.
PAW-FC-903TC



Optional controller.
Advanced wired
remote controller.
PAW-FC-RC1



Infrared remote
supplied with IR
versions.
IR Controller

2-pipe			PAW-FC2A-K007	PAW-FC2A-K009	PAW-FC2A-K018	PAW-FC2A-K022
			PAW-FC2A-K007IR	PAW-FC2A-K009IR	PAW-FC2A-K018IR	PAW-FC2A-K022IR
Total cooling capacity ¹⁾	Lo/Med/Hi	kW	1.0/1.3/1.7	1.6/1.7/2.4	2.8/3.0/3.5	2.9/3.1/3.9
Sensible cooling capacity ¹⁾	Lo/Med/Hi	kW	0.7/1.0/1.2	1.2/1.3/1.9	2.1/2.3/2.7	2.3/2.5/3.1
Water flow	Lo/Med/Hi	l/h	172/231/287	270/291/418	483/508/609	502/535/669
Water pressure drop	Lo/Med/Hi	kPa	18.6/24.9/30.9	18.5/27.0/40.0	34.6/41.3/55.6	37.2/33.7/45.2
Heating capacity ²⁾	Lo/Med/Hi	kW	1.4/1.7/2.0	1.7/2.0/2.7	2.9/3.2/4.0	3.1/3.7/4.4
Sound levels						
Sound power	Lo/Med/Hi	dB(A)	45/49/51	47/52/57	49/53/59	56/59/63
Sound pressure ³⁾	Lo/Med/Hi	dB(A)	32/36/38	34/39/44	40/43/46	43/46/50
Fan						
Number			1	1	1	1
Air flow	Lo/Med/Hi	m ³ /sec	0.08/0.09/0.10	0.10/0.11/0.15	0.15/0.16/0.19	0.17/0.20/0.24
Filter			G1	G1	G1	G1
Electrical data						
Power supply	Voltage	V	230	230	230	230
	Phase		Single phase	Single phase	Single phase	Single phase
	Frequency	Hz	50	50	50	50
Fuse rating		A	3	3	3	3
Power consumption	Lo/Med/Hi	W	39/42/62	30/47/59	44/50/55	50/55/70
Water connections						
Type			Female gas threaded	Female gas threaded	Female gas threaded	Female gas threaded
Water connections		Inch	1/2	1/2	1/2	1/2
Dimensions and weight						
Dimension	HxWxD	mm	275 x 180 x 845	275 x 180 x 845	298 x 200 x 940	298 x 200 x 940
Weight		kg	11	11	13	13
RRP		£	383	423	476	517
RRP with IR Controller		£	423	459	506	553

1) According to Eurovent standard. Air: 27 °C DB / 19 °C WB. Water in / out: 7 °C / 12 °C. 2) According to Eurovent standard. Air: 20 °C. Water in / out: 45 °C / 40 °C. 3) Sound pressure considering a local of 100 m³ a reverberation time of 0.5 seconds and a distance of 1 m.

Technical focus

- 4 sizes
- Cooling capacity from 1.0 to 3.9 kW
- Heating capacity from 1.4 to 4.1 kW
- Version: 2-pipes, AC fan

Main features and accessories

- 2 way or 3 way valve ON / OFF
- 3-speed AC fan motor
- Silent unit for optimum customer comfort
- Aesthetic design suitable for residential and hotel applications
- Compatible with IR controller (supplied with IR versions)
- Coil with hydrophilic fins to improve the condensate flow

Operating limits

Entering water temperature	From 5 to 60 °C
Indoor air temperature	From 6 to 40 °C



Smart fan coils

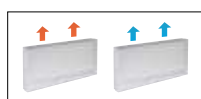

Built-in advanced thermostat.

		PAW-AAIR-200-2	PAW-AAIR-700-2	PAW-AAIR-900-2	
Total cooling capacity	Lo/Med/Hi	kW	0.2/0.3/0.6	0.8/1.0/1.2	1.2/1.5/1.7
Sensible cooling capacity	Lo/Med/Hi	kW	0.2/0.3/0.5	0.6/0.9/1.1	1.1/1.4/1.6
Water flow	Lo/Med/Hi	kg/h	40.0/59.0/95.0	129.0/178.0/207.0	198.0/261.0/300.0
Water pressure drop	Lo/Med/Hi	kPa	0.4/2.0/2.9	1.0/2.0/2.0	6.0/9.0/12.0
Inlet water temperature		°C	10	10	10
Outlet water temperature		°C	15	15	15
Inlet air temperature		°C	27.0	27.0	27.0
Outlet air temperature	Lo/Med/Hi	°C	15.0/17.0/18.0	14.0/16.0/17.0	16.0/17.0/18.0
Relative humidity of inlet air		%	47	47	47
Total heating capacity	Lo/Med/Hi	kW	0.2/0.5/0.6	0.7/1.0/1.2	0.9/1.4/1.7
Water flow	Lo/Med/Hi	kg/h	37.3/80.8/98.0	121.8/177.5/204.3	152.4/244.2/292.9
Water pressure drop	Lo/Med/Hi	kPa	0.4/2.0/2.9	0.3/0.8/1.0	0.5/1.6/2.2
Inlet water temperature		°C	35	35	35
Outlet water temperature		°C	30	30	30
Inlet air temperature		°C	19.0	19.0	19.0
Outlet air temperature	Lo/Med/Hi	°C	38.9/32.0/30.0	33.3/31.8/30.6	30.2/31.1/30.6
Air flow	Lo/Med/Hi	m ³ /sec	0.02/0.03/0.05	0.04/0.07/0.09	0.07/0.10/0.13
Maximum input power	Lo/Med/Hi	W	7.0/9.0/13.0	14.0/18.0/22.0	16.0/20.0/24.0
Sound pressure	Lo/Med/Hi	dB(A)	23/33/40	24/36/42	25/36/44
Dimension (HxWxD)		mm	735x579x129	935x579x129	1135x579x129
Net weight		kg	17	20	23
3 Ways valve included			Yes	Yes	Yes
Touch screen thermostat			Yes	Yes	Yes
RRP		£	665	720	861

* Smart fan coils is produced by Innova.

Accessories	RRP £
PAW-AAIR-LEGS-1 Kits of 2 legs to protect the water pipings	51

Accessories	RRP £
PAW-AAIR-RHCABLE Motor connection cable for units with hydraulic connections on the right	24

Stylish floor-standing fan coils with advanced controller

The slimline of Smart fan coils delivers high efficiency climate control.

With a depth of just under 130 mm they are at the cutting edge of the market. Blending easily into the home, Smart fan coil's elegant design and product refinements are clear to see in every detail.

Exceptional ventilation efficiency means the motor uses considerably less energy (low wattage). The fan speed is continuously modulated by the temperature controller with proportional integral logic, with undoubted advantages for regulating the temperature and humidity in summer mode.

Technical focus

- 4 operation modes (auto, silent, night-time and maximum ventilation speed)
- Exclusive design
- Extremely compact (only 129 mm deep)
- Cooling and dehumidification functions possible (drain is needed)
- 3-way valve included (no overflow valve needed on the installation if more than 3 units installed)
- Touch screen thermostat

With standard cast radiators.

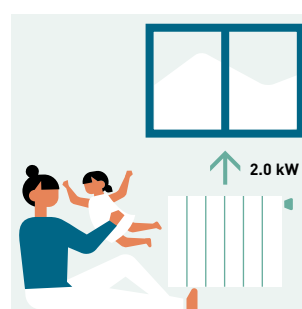

Water at 65 °C needed.

With Smart fan coil.

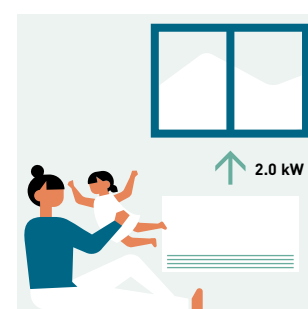

Water at 35 °C needed.

All temperature curves and capacity are available on www.panasonicproclub.com

PRO Club 



Control and connectivity



Simple user friendly control for outdoor units

A control panel with intuitive design is equipped on all ECOi-W systems as standard. The microprocessor based control has a new IHM logic and implements a smart handling for your demand.

Basic operation.

- ON / OFF setting
- Cooling / Heating mode setting

Energy Saving.

- Intelligent logic control for inlet water temperature
- Night setback operation to reduce electrical consumption and noise
- Part load operating mode
- Maximum discharge temperature control

Service / Maintenance.

- Automatic test operation at the push of a button
- Alarm notice with the latest 10 alarms
- Counter for operating hours of compressor and pump
- Compressor operating limits saved in a flash memory

Others.

- BMS compatible (RS485 ModBus RTU or BACnet MSTP protocol)



Remote control kit

PAW-SYSREMKIT

Simple remote control for the need to be installed remotely from the units.

Features:

- 8 lines of display with selectable blue and white back light
- Push-and-roll knob for easy operation
- Schedule function
- Alarm button with LED indicator
- Firmware can be upgraded via USB interface



New remote monitoring service ECOi-W Cloud

PAW-CM000SP041.

Remote access in real time to optimise the service and maintenance work.

Alarm notification via e-mail.

Reporting and graph visualization with 300 varieties.

Various LED signals on the hardware to check the status on site.

Technical focus:

- Maximum 10 outdoor units connectable
- Modbus RTU is required
- History of data interval up to 5 minutes
- 4G SIM card fitted
- IP65 casing
- Optional antenna is available in the case that 4G signal is not good enough



Wired controllers for AC and EC fan coils

Advanced wired remote controller (AC)

PAW-FC-RC1

This advanced controller provides a higher level of comfort in heating. The sensor can be used as a water flow sensor, stopping the fan when the water temperature is low, avoiding cold drafts in winter.

Features:

- For 2-pipe and 4-pipe, AC fan
- Change Over function (cold draft prevention)
- Room thermostat
- 3 outputs, 230 V relays for fan control
- 2 outputs, 230 V relays for heating / cooling control
- Connection to BMS - Modbus RTU slave
- 1 DI for presence detection (key card switch)
- 1 AI for sensor



Wired remote controller (EC)

PAW-FC-907TC

Stylish and sophisticated design with backlit LCD display, is suitable for installation within a wide variety of locations such as office, hotel and residential applications. By connecting the controller to the range of EC fan coils, the user can take advantage of the improved performance, higher levels of efficiency and thus improved energy savings.

Features:

- For 2-pipe and 4-pipe, EC fan
- Back lit LCD screen with touch control
- Adjustable range EC fan control
- Economiser
- Connection to BMS via Modbus
- 1 DI for presence detection (key card switch)



Wired remote controller (AC)

PAW-FC-903TC









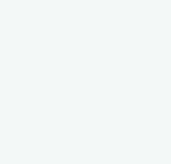
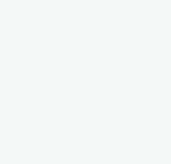

Feature rich and perfectly adapted to control AC fan coils, the PAW-FC-903TC is the addition for any fan coil. With intuitive user interface provided by the push button control and large LCD display, it will fit seamlessly with almost any location.

Features:

- For 2-pipe, AC fan
- Back lit LCD screen
- 3 speed control relay, for fan
- Economizer

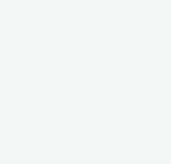

Accessories and control

Wired remote controller for outdoor units		Remote monitoring service ECOi-W Cloud			
 <p>Remote control for the need to be installed remotely from the units.</p> <p>----- PAW-SYSREMKIT 0000 €</p>		 <p>Cloudgate plug and play IP65 box mobile 4G Europe.</p> <p>----- PAW-CM000SP041 TBC €</p>	 <p>Extension kit and cable gland for mobile (2/4G) antenna (3 m).</p> <p>----- PAW-CM000K0001 TBC €</p>	 <p>Tservice wireless fee for 1 year. Periodic prepaid subscriptions identified by software "tokens" loaded in customer's private portal.</p> <p>----- PAW-00SRTS011 TBC €</p>	
Shut off valves			Victaulic connection kit		
 <p>Shut off valves kit for model 20 - 40.</p> <p>----- PAW-SYSSOV1 0000 €</p>		 <p>Shut off valves kit for model 45 - 75.</p> <p>----- PAW-SYSSOV2 0000 €</p>	 <p>Shut off valves kit for model 90 - 125.</p> <p>----- PAW-SYSSOV3 0000 €</p>	 <p>Victaulic connection kit for model 140 - 210.</p> <p>----- PAW-SYSVICTH 0000 €</p>	
Wired remote controller for fan coil					
 <p>Wired remote controller for fan coil.</p> <p>----- PAW-FC-903TC 81 €</p>		 <p>Advanced wired remote controller for fan coil.</p> <p>----- PAW-FC-RC1 90 €</p>		 <p>Wired remote controller for EC fan coil.</p> <p>----- PAW-FC-907TC 136 €</p>	
Fan coil ceiling, floor-standing and ducted valve accessories					
<p>2 way valve + drain pan for 2-pipe ceiling, floor-standing and ducted models 010-060.</p> <p>----- PAW-FC-2WY-11/55-1 63 €</p>		<p>2 way valve + drain pan for 2-pipe ceiling, floor-standing and ducted models 070-080.</p> <p>----- PAW-FC-2WY-65/90-1 72 €</p>		<p>2 way valve + drain pan for 2-pipe ducted model F040.</p> <p>----- PAW-FC-2WY-F040 85 €</p>	
<p>3 way valve + drain pan for 2-pipe ceiling, floor-standing and ducted models 010-060.</p> <p>----- PAW-FC-3WY-11/55-1 93 €</p>		<p>3 way valve + drain pan for 2-pipe ceiling, floor-standing and ducted models and 070-080.</p> <p>----- PAW-FC-3WY-65/90-1 104 €</p>		<p>3 way valve + drain pan for 2-pipe ducted model F040.</p> <p>----- PAW-FC-3WY-F040 138 €</p>	
<p>2 way valve + drain pan for 4-pipe ceiling, floor-standing and ducted models 010-060.</p> <p>----- PAW-FC4-2WY-010 113 €</p>		<p>2 way valve + drain pan for 4-pipe ceiling, floor-standing and ducted models 070-080.</p> <p>----- PAW-FC4-2WY-070 121 €</p>		<p>2 way valve + drain pan for 4-pipe ducted model F040.</p> <p>----- PAW-FC4-2WY-F040 143 €</p>	
<p>3 way valve + drain pan for 4-pipe ducted, ceiling and floor-standing model 010.</p> <p>----- PAW-FC4-3WY-010 182 €</p>		<p>3 way valve + drain pan for 4-pipe ceiling, floor-standing and ducted models 020-060.</p> <p>----- PAW-FC4-3WY-020 182 €</p>		<p>3 way valve + drain pan for 4-pipe ceiling, floor-standing and ducted models 070-080.</p> <p>----- PAW-FC4-3WY-070 223 €</p>	
<p>3 way valve + drain pan for 4-pipe ducted model F040</p> <p>----- PAW-FC4-3WY-F040 253 €</p>					

Fan coil high static ducted valve accessories

2 way valve + drain pan for 2-pipe high static ducted models E070. ----- PAW-FC2-2WY-E070 157 €	2 way valve + drain pan for 2-pipe high static ducted models E150-E180. ----- PAW-FC-2WY-150 153 €	2 way valve + drain pan for 2-pipe high static ducted models E210-E240. ----- PAW-FC2-2WY-E210 223 €
3 way valve + drain pan for 2-pipe high static ducted models E070. ----- PAW-FC2-3WY-E070 277 €	3 way valve + drain pan for 2-pipe high static ducted models E150-E180. ----- PAW-FC-3WY-150 198 €	3 way valve + drain pan for 2-pipe high static ducted models E210-E240. ----- PAW-FC2-3WY-E210 348 €
2 way valve + drain pan for 4-pipe high static ducted model E070. ----- PAW-FC4-2WY-E070 249 €	2 way valve + drain pan for 4-pipe high static ducted models E150-E180. ----- PAW-FC4-2WY-E150 255 €	2 way valve + drain pan for 4-pipe high static ducted models E210-E240. ----- PAW-FC4-2WY-E210 312 €
3 way valve + drain pan for 4-pipe high static ducted model E070. ----- PAW-FC4-3WY-E070 382 €	3 way valve + drain pan for 4-pipe high static ducted models E150-E180. ----- PAW-FC4-3WY-E150 382 €	3 way valve + drain pan for 4-pipe high static ducted models E210-E240. ----- PAW-FC4-3WY-E210 437 €

Fan coil cassette valve accessories

2 way valve + drain pan for 2-pipe cassette models U020-U040. ----- PAW-FC2-2WY-U020 181 €	2 way valve + drain pan for 2-pipe cassette models U050-U070. ----- PAW-FC2-2WY-U050 181 €	3 way valve + drain pan for 2-pipe cassette models U020-U040. ----- PAW-FC2-3WY-U020 181 €	3 way valve + drain pan for 2-pipe cassette models U050-U070. ----- PAW-FC2-3WY-U050 181 €
2 way valve + drain pan for 4-pipe cassette models U020-U040. ----- PAW-FC4-2WY-U020 302 €	2 way valve + drain pan for 4-pipe cassette models U050-U070. ----- PAW-FC4-2WY-U050 302 €	3 way valve + drain pan for 4-pipe cassette models U020-U040. ----- PAW-FC4-3WY-U020 302 €	3 way valve + drain pan for 4-pipe cassette models U050-U070. ----- PAW-FC4-3WY-U050 302 €

Fan coil wall-mounted valve accessories

2 way valve for 2-pipe wall-mounted K007-K022. ----- PAW-FC2-2WY-K007 75 €	3 way valve for 2-pipe wall-mounted K007-K022. ----- PAW-FC2-3WY-K007 120 €
---	--

Smart fan coil accessories

Kits of 2 legs to protect the water pipings. ----- PAW-AAIR-LEGS-1 51 €	Motor connection cable for units with hydraulic connections on the right. ----- PAW-AAIR-RHCABLE 24 €
--	--



Panasonic condensing units with natural refrigerant

Panasonic's CR Series of CO₂ condensing units provide the ideal solution for supermarkets, convenience stores and gas stations.

Keeping food always fresh at right temperature in showcases or cold rooms is a very critical point. And one of the biggest challenges for those retailers has been the expensive effects of refrigeration breakdowns which can result in costly product wastage.

CO ₂ transcritical condensing units - CR Series	→ 216
Choose the sustainable green solution by Panasonic	→ 218
CO ₂ Condensing units - CR Series	→ 219

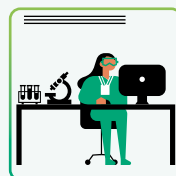
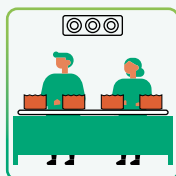

CO₂ transcritical condensing units - CR Series

4 HP MT/LT Type, a new line-up in CR Series, offers a wide range of refrigeration systems, meeting the specific needs of small retail stores.



1 Superior efficiency with reliable quality

- Panasonic has combined the 2-stage compressor with the split cycle for increased efficiency
- High seasonal performance. SEPR: Maximum 3.83 in cooling, 1.92 in freezing ¹⁾
- High COP at high ambient temperature

1) 200VF5A.

2 Flexible installation

- Set-points at medium or low temperature available depending on applications
- Compact unit
- Silent operation
- Long piping length: Maximum 100 m ²⁾
- High external static pressure ²⁾
- Transfer pressure control for stable expansion valve control in showcases ²⁾

2) 1000VF8/8A.

3 Heat recovery port as renewable energy

- Maximum 16.7 kW of heating for free
- Optional possibility to get subsidy (depending on location)
- Easy connection process

Why CO₂?: Natural refrigerant

EU F-Gas regulation is a key priority for European countries. It ensures compliance with the Kigali Amendment supporting international climate commitments on greenhouse gases and leading the global transition to climate-friendly HFC-free technologies. Carbon dioxide (R744) is regaining its place in the refrigeration world. Driven by environmental concerns, legislation now requires increased adoption of 'alternative' refrigerants, such as CO₂. CO₂ is an environmentally-friendly solution, with zero ODP and "GWP" (Global Warming Potential)=1 means natural substance in the atmosphere.

In Europe a step-by-step HFC reduction has been in place since the F-Gas regulation was introduced in 2015. Countries all over the world have actively been preparing to enact the necessary domestic legislation to implement the agreement to reduce the use of HFCs. Panasonic is now able to provide a solution in Europe with CO₂ refrigeration systems to prevent global warming and to support environment-friendly retail operations. The following table shows how well R744 (CO₂) performs regarding environmental impact and safety.

ODP (Ozone Depletion Potential) = 0 - GWP (Global Warming Potential) = 1.

	Next generation refrigerant			Current refrigerant	
	CO ₂	Ammonia	Isobutane	R410A	R404A
ODP	0	0	0	0	0
GWP	1	0	4	2090	3920
Flammability	Non flammable	Light flammable	Flammable	Non flammable	Non flammable
Toxicity	No	Yes	No	No	No

Superior cooling capacity at each evaporating temperature

CO₂ transcritical condensing units have a high cooling capacity at each set point. The CO₂ 2-stage compressor developed by Panasonic is designed to compress CO₂ refrigerant twice; it reduces the load in operation by half (compared to 1-stage refrigerant compression) and delivers increased durability and reliability.

Units can be programmed to run at low and medium temperatures at initial set-up. These settings can then be modified by turning a simple and user friendly rotary switch to further enhance energy savings.

CR Series	Low temperature	Medium temperature	ET (Evaporation Temperature) set points range	Room size example (LT / MT)*
OCU-CR200VF5A	✓	✓	-45 ~ -5 °C	10 m ³ / 40 m ³
OCU-CR400VF8	—	✓	-20 ~ -5 °C	— / 80 m ³
OCU-CR400VF8A	✓	✓	-45 ~ -5 °C	20 m ³ / 80 m ³
OCU-CR1000VF8	—	✓	-20 ~ -5 °C	— / 200 m ³
OCU-CR1000VF8A	✓	✓	-45 ~ -5 °C	50 m ³ / 200 m ³

* Room size is reference. Please contact to authorized Panasonic dealer for calculation.

MT/LT TYPE
200VF5A
4 kW / 2 kW

MT TYPE
400VF8 - 7.5 kW
NEW MT/LT TYPE
400VF8A
8 kW / 4 kW

MT TYPE
1000VF8 - 15 kW
MT/LT TYPE
1000VF8A
16 kW / 8 kW

3.83* SEPR COOLING | **1.92* SEPR FREEZING**

* SEPR values has been tested at 3-part laboratory.



900 mm



1143 mm



890 mm

Panasonic's combined technology of the 2-stage compressor with the split cycle

- Panasonic 2-stage rotary compressor delivering powerful performance for more than 20 years
- Split cycle* enhances cooling effect

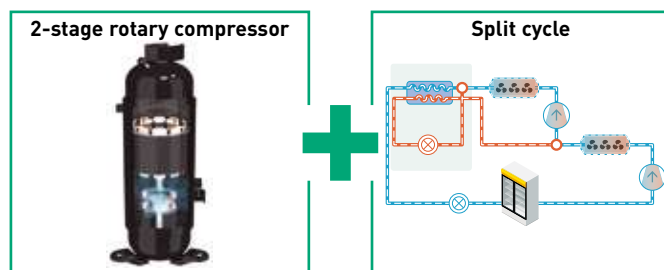
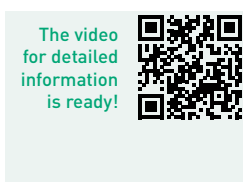

Standard cycle.

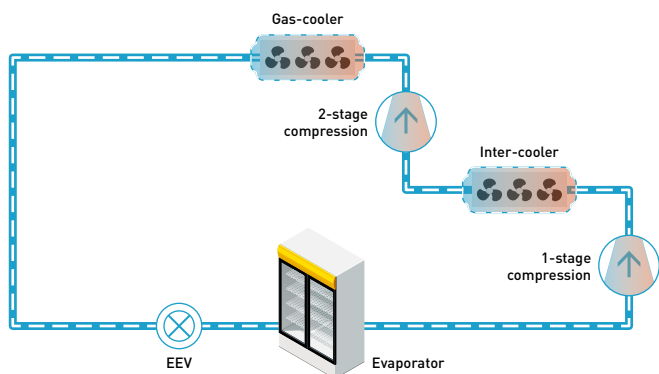

Split cycle.

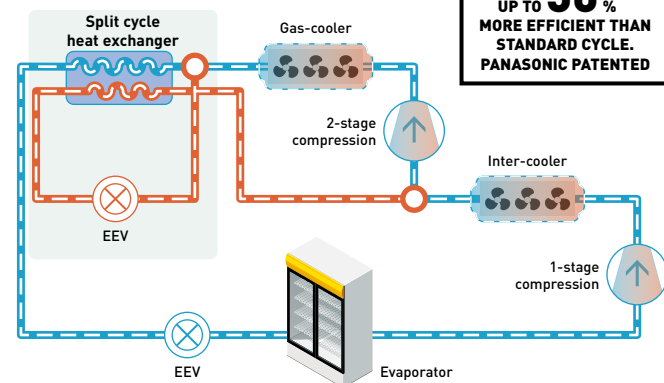

UP TO 50%
MORE EFFICIENT THAN
STANDARD CYCLE.
PANASONIC PATENTED**

New control panel and electric expansion valves.

An intelligent controller has been redesigned with a compact chassis. This controller has the smart program especially for showcases and cold rooms.

Electric expansion valves (EEVs) are ready with 7 different sizes to meet precisely the field demand.



Intelligent controller with compact chassis.

- MPXPRO control
- Size: 300 x 220 x 120 mm

Model reference
PAW-CO2-PANEL-C



Electric expansion valves (EEVs) line-up.

Model reference	
PAW-E2V03CWAC0	PAW-E2V14CWAC0
PAW-E2V05CWAC0	PAW-E2V18CWAC0
PAW-E2V09CWAC0	PAW-E2V24CWAC0
PAW-E2V11CWAC0	

Choose the sustainable green solution by Panasonic

Environmentally friendly CO₂ condensing units.

Modbus compatibility with monitoring system

Panasonic CO₂ condensing units - CR Series can be supervised by major monitoring system such as CAREL, Eliwell, Danfoss and RDM. Monitoring system ensures the recording, monitoring and reporting of temperature conditions etc... of entire CO₂ condensing units system at shops.

Monitoring system

			
Standard boss & boss-mini	AK-SM Series*	TelevisGo	DMTOUCH

* M2M1-10 gateway (Model code: FDS021) is required in addition to the monitoring system. M2M1-10 gateway is a local supply.

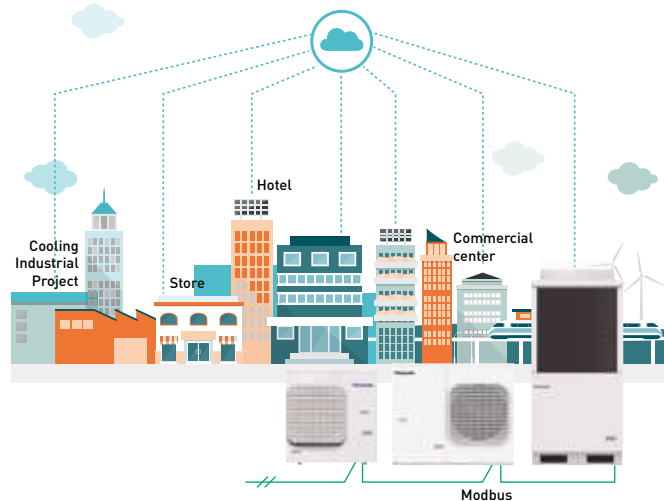

New CO₂ service checker

The service checker is a useful tool which supports your technical tasks on the field such as commissioning, maintenance and troubleshooting for Panasonic CO₂ condensing units - CR Series. Panasonic will supply the DRX file where the Panasonic unit's library is included with the acquisition of the CO₂ service checker.

Main features:

- Reading and recording variable technical parameters
- Setting change of operating values possible
- 2D graph visualization for the detailed analysis
- Monitoring an alarm status, for example the status of the compressor oil level



Model reference

PAW-CO2-CHECKER

To use it, is necessary to download free Device Manager software from the Eliwell website:

Visit: <https://www.eliwell.com/en/Family/DeviceManager.html> using this QR.

Eliwell product name: Device Manager 100. Eliwell part number: DMP1000002000.



Design support tool available in Panasonic PRO Club.

Panasonic has launched a new online calculator to support engineers, installers, and technicians to quickly make calculations when specifying solutions for commercial refrigeration systems. The calculator can be found on Panasonic's PRO Club.

- Evaporation temperature selection
- Cooling capacity calculator
- Refrigerant pipe calculation
- Electric expansion valves calculation
- Refrigerant amount calculation

Ready to works on all devices, computers, tablets and smartphones!!



PRO Club

www.panasonicproclub.com or connect simply with your smartphone to the PRO Club using this QR



CO₂ Condensing units - CR Series

Please contact Panasonic for RRP.



Standard model		OCU-CR200VF5A	OCU-CR400VF8	OCU-CR400VF8A	OCU-CR1000VF8	OCU-CR1000VF8A			
Anti corrosion coating model		OCU-CR200VF5ASL	OCU-CR400VF8SL	OCU-CR400VF8ASL	OCU-CR1000VF8SL	OCU-CR1000VF8ASL			
Type (MT: medium temp. LT: low temp.)		MT (4 kW) / LT (2 kW)	MT (7.5 kW)	MT (8 kW) / LT (4 kW)	MT (15 kW)	MT (16 kW) / LT (8 kW)			
Power supply	Voltage	V	220/230/240	380/400/415	380/400/415	380/400/415	380/400/415		
	Phase		Single phase	Three phase	Three phase	Three phase	Three phase		
	Frequency	Hz	50	50	50	50	50		
Cooling capacity at ET -10 °C AT 32 °C	kW	3.70	7.10	7.7	14.00	15.10			
Cooling capacity at ET -35 °C AT 32 °C	kW	1.80	—	3.8	—	8.00			
Evaporator connection		Multiple	Multiple	Multiple	Multiple	Multiple			
Evaporation temperature	Min ~ Max °C	-45 ~ -5	-20 ~ -5	-45 ~ -5	-20 ~ -5	-45 ~ -5			
Ambient temperature	Min ~ Max °C	-20 ~ +43	-15 ~ +43	-20 ~ +45	-15 ~ +43	-15 ~ +43			
Refrigerant		R744	R744	R744	R744	R744			
Design pressure liquid line	Mpa	12	8	8	8	8			
Design pressure suction line	Mpa	8	8	8	8	8			
User system external alarm. Digital input. Non-voltage contact		Yes	Yes	Yes	Yes	Yes			
Liquid tube electromagnetic valve	Vac	220/230/240	220/230/240	220/230/240	220/230/240	220/230/240			
Showcase operation ON / OFF signal. Digital input. Non-voltage contact		Yes	Yes	Yes	Yes	Yes			
Modbus communication line (RS485)	Ports	2	2	2	2	2			
Compressor type		2- stage rotary	2- stage rotary	2- stage rotary	2- stage rotary	2- stage rotary			
Dimension	HxWxD mm	930x900x437	948x1143x609	948x1143x609	1941x890x890	1941x890x890			
Net weight	Kg	70	136	136	293	320			
Piping diameter	Suction pipe	Inch (mm)	3/8(9.52)	1/2(12.70)	1/2(12.70)	3/4(19.05)	3/4(19.05)		
	Liquid pipe	Inch (mm)	1/4(6.35)	3/8(9.52)	3/8(9.52)	5/8(15.88)	5/8(15.88)		
Length of connection piping	m	25	50	50	100 ¹⁾	100 ¹⁾			
PED	CAT	I	II	II	II	II			
Air flow	m ³ /sec	0.90	0.98	0.98	3.67	3.67			
External static pressure	Pa	17	50	50	58	58			
Heat recovery port		—	—	Yes	—	Yes			
Standard performance									
Ambient temperature	°C	32	32	32	32	32			
Evaporating temperature	°C	-10	-35	-10	-10	-35			
Cooling capacity	kW	3.70	1.80	7.10	7.7	3.8	14.00	15.10	8.00
Power consumption	kW	1.79	1.65	4.00	4.5	3.8	8.20	8.20	7.57
Nominal load ampere	A	7.94	7.26	6.14	7.2	6.2	12.60	12.60	11.60
Sound pressure	dB(A)	35.5 ²⁾	35.5 ²⁾	33 ³⁾	33 ³⁾	33 ³⁾	36.0 ⁴⁾	36.0 ⁴⁾	36.0 ⁴⁾

Necessary accessories						
Drier filter liquid line, diameter 6.35 mm	D-152T	Yes (included: delivered with the unit)	Yes (included: delivered with the unit)	Yes (included: delivered with the unit)	—	—
Drier filter liquid line, diameter 15.88 mm	D-155T	—	—	—	Yes (included: delivered with the unit)	Yes (included: delivered with the unit)
Suction filter, diameter 19.05 mm (outer diameter welding)	S-008T	—	Yes (included: delivered with the unit)	Yes (included: delivered with the unit)	Yes (included: delivered with the unit)	Yes (included: delivered with the unit)

1) PZ-68S (refrigeration oil) must be added if >50 m. 2) ET-10 °C, 65 S-1, 10 m from product. 3) ET-10 °C, 80 S-1, 10 m from product. 4) ET -10 °C, 60 S-1, 10 m from product.

Accessories	
PAW-CO2-PANEL-C	Panel with MPXPRO control, stator, probes, etc.
SPK-TU125	Tube connector adaptor for vacuum and service
CZ-CO2LBR0L500	Lubrication oil PZ-68S (0,5 L)
PAW-E2V03CWACO	Electric expansion valve 3,8" ODF high pressure without stator, size 3
PAW-E2V05CWACO	Electric expansion valve 3,8" ODF high pressure without stator, size 5
PAW-E2V09CWACO	Electric expansion valve 3,8" ODF high pressure without stator, size 9
PAW-E2V11CWACO	Electric expansion valve 3,8" ODF high pressure without stator, size 11
PAW-E2V14CWACO	Electric expansion valve 3,8" ODF high pressure without stator, size 14
PAW-E2V18CWACO	Electric expansion valve 3,8" ODF high pressure without stator, size 18
PAW-E2V24CWACO	Electric expansion valve 3,8" ODF high pressure without stator, size 24
PAW-CO2-CHECKER	CO ₂ service checker

Spare parts for service and maintenance	
80203513179000	Suction filter, diameter 19,05 mm (outer diameter welding)
80203517115003	Lubrication oil PZ-68S (4,0 L)*
80203517117000	Lubrication oil PZ-68S (0,5 L)*
80203513180000	Filter dryer D-152T (type CO-082-S)
80203513179000	Filter dryer D-155T (type CO-085-S)

* You can find the PZ-68S oil "Safety Sheet" in the SAFETY section of our pipe selection software, available on our PRO Club platform.



Energy saving



Refrigerant gas R32 Our heat pumps containing the refrigerant R32 show a drastic reduction in the value of Global Warming Potential (GWP).



ErP 35°C

Better efficiency and Value for low temperature applications. Energy efficiency class up to A+++ in a scale from A+++ to D.



DHW

Better efficiency and Value for domestic hot water. Energy efficiency class up to A+ in a scale from A+ to F.



9.50 SEER

Exceptional Seasonal Cooling Efficiency based on the new ErP regulation. Higher SEER ratings mean greater efficiency - year-round cooling savings!



5.20 SCOP

Exceptional Seasonal Heating Efficiency based on the new ErP regulation. Higher SCOP ratings mean greater efficiency - year-round heating savings!



ECONAVI

Domestic Econavi. Sunlight Sensor technology can detect and reduce the waste of energy by optimising air conditioner operation according to room conditions. With just one touch of a button, you can save energy.



ECONAVI

Commercial Econavi. Intelligent Human Activity Sensor and new Sunlight Sensor technologies that can detect and reduces the waste of energy by optimising air conditioner operation according to room conditions. With just one touch of a button, you can save energy.



INVERTER+

Inverter Plus System classification highlights Panasonic's highest performing systems.



INVERTER

Inverter. The Inverter range provides greater efficiency and comfort. Provides more precise temperature control, without highs and lows, and keeps the ambient temperature constant with lower energy consumption and a significant reduction in noise and vibration levels.



R2 ROTARY COMPRESSOR

Panasonic R2 Rotary Compressor. Designed to withstand extreme conditions, it delivers high performance and efficiency.



HIGH EFFICIENCY COMPRESSOR

High efficiency compressor. Compressors that operate with a wider Hz range realize a more efficient operation throughout the year. For Big PACi Series.



ALL INVERTER COMPRESSORS

All inverter compressors. Multiple large-capacity all inverter compressors (more than 14 HP). Two independently controlled inverter compressors achieve high efficiency. Redesigned components in the body provide performance improvement especially in the rated cooling condition and EER performance.



HIGH COP

High efficiency models performs higher COP than standard units and standard combinations.



ECO G

ECO G technology offers the best in energy efficiency. ECO G gas VRF is specially designed for buildings where the electricity is restricted or CO₂ emissions must be reduced.



CO₂ R744

Natural CO₂ / R744. R744 refrigerant provides higher energy saving and lower CO₂ emission compared to R404A. Zero ODP and GWP=1 means natural substance.



4.68

High seasonal efficiency in cooling mode. SEER follows COMMISSION REGULATION (EU) No 2016/2281.



3.55

High seasonal efficiency in heating mode. SCOP follows COMMISSION REGULATION (EU) No 813/2013.



ECOi-W Series are compliant with ErP regulation. SEER follows COMMISSION REGULATION (EU) No 2016/2281. SCOP follows COMMISSION REGULATION (EU) No 813/2013.



EC MOTOR GREEN VENTILATION

EC motor green ventilation. Range of fan coil with improved efficiency with optional EC fan motor.

High performance and indoor air quality



DHW

DHW. With Aquarea you can also heat your domestic hot water at a very low cost with the optional hot water cylinder.



OUTPUT WATER

45 °C Output water. Maximum water outlet temperature up to 45°C.



nanoeX

nanoe™ X. Technology with the benefits of hydroxyl radicals has the capacity to inhibit pollutants, viruses, and bacteria to clean and deodorise.



PM2.5 FILTER

PM2.5 filter. Particulate matter (PM2.5) can be found suspended in the air, including dust, dirt, smoke and liquid droplets. This filter can catch PM2.5 particles including hazardous pollutants as well as house dust and pollen.



19 dB(A)

Super Quiet. With Super Quiet technology our devices are quieter than a library (30 dB(A)).



SUPER QUIET

Super quiet. Extra quiet operation is available as standard (with sizes 20 – 40, 140 – 210).



HUMIDITY CONTROL MILD DRY

Fine control helps prevent a rapid decrease in room humidity while maintaining the set temperature. Maintains an RH* up to 10 % higher than cooling operation (*RH: Relative Humidity). Ideal when sleeping with the air conditioner on.



HUMIDITY CONTROL DRY

Mild Dry. By intermittent control of compressor and indoor unit's fan, "Mild Dry" gives you comfort. It realizes efficient dehumidification according to room temperature.



AEROWINGS

More comfort with Aerowings. Direct air flow to the ceiling, creating a shower cooling effect with built-in twin flap.



STATIC PRESSURE UP TO 7 mmAq

Static pressure up to 7 mmAq. Low static pressure hide-away RAC with selectable static pressure up to 7 mmAq.



FILTER INCLUDED

Filter included. Hide-away with filter included.



BLUEFIN

Bluefin. Panasonic has extended the life of its condensers with an original anti-rust coating.



LARGE FAN

Large fan provides larger air flow rate and very quiet operation at low speed.



DC FAN

DC fan: Safe and precise.



AUTOMATIC FAN

Automatic fan operation. Convenient microprocessor control automatically adjusts fan speed to High, Medium or Low, corresponding to room sensor and maintains comfortable air flow throughout the room.



SELF-DIAGNOSING

Self-diagnosing function. By using electronic control valves past warnings are stored. This makes it easier to diagnose malfunctions, reducing service labour and therefore costs.



AUTO-FLAP CONTROL

Comfortable auto-flap control. When the unit is first turned on, flap position is automatically adjusted in accordance with the cooling or heating operation.



AUTOMATIC RESTART

Automatic restart. Automatic restart function for power failure. Even when power failure occurs, preset programmed operation can be reactivated once power is resumed.



AIR SWEEP

Air Sweep. The air sweep function moves the flap up and down in the air outlet, directing air in a "sweeping" motion around the room and providing comfort in every corner.



BUILT-IN DRAIN PUMP

Built-in drain pump. Maximum head 50 cm (or 75 cm for U type) from the bottom of the unit.



ULTIMATE CUSTOMISATION

Ultimate customisation. Various pump, hydraulic, ambient options offered, plus many more. Ultimate customization for your needs and environment.



DEFROST LIMITING

Defrost limiting cycle (140 – 210). Each pair of coils can be defrosted wisely while the other pair of coils are running in heating mode. This alternated defrost cycle ensures stable hot water even at low ambient conditions.



COOLING MODE

Down to -10 °C in cooling mode. The air conditioner works in cooling mode when the outdoor temperature of -10 °C.



HEATING MODE

Down to -15 °C in heating mode. The air conditioner works in heat pump mode when the outdoor temperature is as low as -15 °C.



OPERATION RANGE

-20 °C operating range. The PRO-HT Tanks work with an outdoor temperature is as low as -20 °C.



COOLING MODE

Cooling with outdoor temperature up to 52 °C. The ECOi EX system works in cooling mode with performance data at outdoor temperature up to 52 °C.



AMBIENT TEMPERATURE

Operating range up to 43 °C. The system operates up to 43 °C, allowing for installation in various locations.



ANTI CORROSION COATING

Anti corrosion coating. Selectable fin type with or without an anti corrosion coating. The anti corrosion coating prevents salt damage for a longer lifespan.



HEAT RECOVERY PORT

Heat recovery port. The heat recovery port is available to cut running costs as optional. By utilizing exhausted heat generated by refrigeration to the energy source for heating.



R22 R410A R22 / R410A RENEWAL

R410A/R22 renewal. The Panasonic renewal system allows good quality existing R410A or R22 pipe work to be re-used whilst installing new high efficiency R32 systems.



R22 RENEWAL

R22 renewal. The Panasonic renewal system allows good quality existing R22 pipe work to be re-used whilst installing new high efficiency R410A systems.

High connectivity



ADVANCED CONTROL

Advanced control. Remote controller with full dotted 3.5" wide back light screen. Menu with 17 available languages easy to use for installer and user. Included on J and H Generation.



INTEGRATION TO P-LINK

Domestic integration to P-Link - CZ-CAPRA1. Can connect RAC range to P-Link. Full control is now possible.



OPTIONAL WI-FI

Internet control. A next generation system providing user-friendly remote control of air conditioning or heat pump units from everywhere, using a simple Android™ or iOS smartphone, tablet or PC via the internet.



BMS CONNECTIVITY

Connectivity. The communication port can be integrated into the indoor unit and provides easy connection to, and control of, your Panasonic heat pump to your home or building management system.



PANASONIC AC SMART CLOUD

Panasonic AC Smart Cloud. The AC Smart Cloud from Panasonic allows you to have complete control of all your installations. In a simple click, receive status updates from all your units in real-time, preventing breakdowns and optimising costs.

Legacy Sanyo replacement technology from Panasonic

In almost all circumstances it is possible to replace old Sanyo units with current Panasonic models however, each Sanyo generation has different criteria to consider when replacing. Below we have outlined how to replace each generation.

GHP - J2 - 2-Pipe	
Sanyo MODEL	PANASONIC MODEL
SGP-E70J2GU2	No Equivalent
SGP-E90J2GU2	No Equivalent
SGP-E120J2GU2	No Equivalent
SGP-E150J2GU2	U-16GE3E5
SGP-E190J2GU2	U-20GE3E5

GHP - K1 - 2-Pipe	
Sanyo MODEL	PANASONIC MODEL
SGP-E70K1GU2	No Equivalent
SGP-E90K1GU2	No Equivalent
SGP-E120K1GU2W	No Equivalent
SGP-E150K1GU2W	U-16GE3E5
SGP-E190K1GU2W	U-20GE3E5
SGP-E240K1GU2W	U-25GE3E5

GHP - M2 - 2-Pipe	
SANYO MODEL	PANASONIC MODEL
SGP-EW150M2G2W	U-16GE3E5
SGP-EW190M2G2W	U-20GE3E5
SGP-EW240M2G2W	U-25GE3E5

GHP - J2 - 3-Pipe	
SANYO MODEL	PANASONIC MODEL
SGP-EZ190J2GU2	U-20GF3E5

GHP - K1 - 3-Pipe	
SANYO MODEL	PANASONIC MODEL
SGP-EZ190K1GU2	U-20GF3E5

GHP - M2 - 3-Pipe	
SANYO MODEL	PANASONIC MODEL
SGP-EW120M2G2W	No Equivalent
SGP-EZ150M2G2	U-16GF3E5
SGP-EZ190M2G2	U-20GF3E5
SGP-EZ240M2G2	U-25GF3E5

GHP - ECO G Power	
SANYO MODEL	PANASONIC MODEL
SGP-EGW190M2G2W	No Equivalent

VRF - Indoor Units

Model Size	Cassette 90x90	Duct	Ceiling	Wall
	X***XH	U***XH	T***XH	K***XH
	XDR***GXH56	UR***GXH56	TDR***GXH56	KR***GXH56
74 / 75 / 76	S-22MU2E5B	S-22MF3E5A	—	S-22MK2E5B
94 / 95 / 96	S-28MU2E5B	S-28MF3E5A	—	S-28MK2E5B
124 / 125 / 126	S-36MU2E5B	S-36MF3E5A	S-36MT2E5A	S-36MK2E5B
164 / 165 / 166	S-45MU2E5B	S-45MF3E5A	S-45MT2E5A	S-45MK2E5B
184 / 185 / 186	S-56MU2E5B	S-56MF3E5A	S-56MT2E5A	S-56MK2E5B
254 / 255 / 256	S-73MU2E5B	S-73MF3E5A	S-73MT2E5A	S-73MK2E5B
364 / 365 / 366	S-106MU2E5B	S-106MF3E5A	S-106MT2E5A	S-106MK2E5B
484 / 485 / 486	S-140MU2E5B	S-140MF3E5A	S-140MT2E5A	—
604 / 605 / 606	S-160MU2E5B	S-160MF3E5A	—	—

4 & 5 Series Indoor Units: Above is a table showing the current Panasonic equivalent for each Sanyo indoor model. Indoor units can be added or replaced without any setting changes. Please note there have been design changes therefore dimensions and appearances will not be the same. Please check in technical manual.

VRF - Mini ECOi	
Sanyo Reference	Panasonic Equivalent
SPW-CR365GX(H)56(B)	U-4LE2E5
SPW-CR485GX(H)56(B)	U-5LE2E5
SPW-CR605GX(H)56(B)	U-6LE2E5
SPW-CR365GXH8B	U-4LE2E8
SPW-CR485GXH8B	U-5LE2E8
SPW-CR605GXH8B	U-6LE2E8

VRF - 6 Series 2-Pipe	
Sanyo Reference	Panasonic Equivalent
SPW-C0706DXH8	U-8ME2E8
SPW-C0906DXH8	U-10ME2E8
SPW-C1156DXH8	U-12ME2E8
SPW-C1306DXH8	U-14ME2E8
SPW-C1406DXH8	U-16ME2E8
SPW-C1606DXH8	U-18ME2E8
SPW-C1806DXH8	U-20ME2E8

VRF - 5 Series 2-Pipe	
Sanyo Reference	Panasonic Equivalent
SPW-C0705DXHN8	U-8ME2E8
SPW-C0905DXHN8	U-10ME2E8
SPW-C1155DXHN8	U-12ME2E8
SPW-C1305DXHN8	U-14ME2E8
SPW-C1405DXHN8	U-16ME2E8

VRF - 5 Series Outdoor Units - 3-Pipe	
Sanyo Reference	Panasonic Equivalent
SPW-C0705DZH8	U-8MF3E8
SPW-C0905DZH8	U-10MF3E8
SPW-C1155DZH8	U-12MF3E8
SPW-C1305DZH8	U-14MF3E8
SPW-C1405DZH8	U-16MF3E8

Please be advised that when replacing Sanyo outdoor unit with any U-***MF3E8 outdoor unit. It is necessary to take into consideration that the discharge pipe length is required for additional refrigerant charge.



VRF - 4 Series Outdoor Units - 3-Pipe

Sanyo Reference	Panasonic Equivalent
SPW-CR704GDZH8	U-8MF3E8
SPW-CR904GDZH8	U-10MF3E8
SPW-CR1154GDZH8	U-12MF3E8
SPW-CR1304GDZH8	U-14MF3E8
SPW-CR1404GDZH8	U-16MF3E8
SPW-CR704GDZH8B	U-8MF3E8
SPW-CR904GDZH8B	U-10MF3E8
SPW-CR1154GDZH8B	U-12MF3E8
SPW-CR1304GDZH8B	U-14MF3E8
SPW-CR1404GDZH8B	U-16MF3E8

Please be advised that when replacing Sanyo outdoor unit with any U-***MF3E8 outdoor unit. It is necessary to take into consideration that the discharge pipe length is required for additional refrigerant charge.

VRF - 3 Series 3-Pipe - R407c

Sanyo Reference	Panasonic Equivalent
SPW-CR703GZH8	U-8MF3E8
SPW-CR903GZH8	U-10MF3E8

This generation runs on R407c refrigerant so it is always best practice to replace all equipment and take advantage of Panasonic's renewal technologies. However in situations where this is not feasible then it is possible to replace indoors and also outdoor units with conditions. When carrying out these replacements it is particularly important to check the wall thickness and integrity of the pipework is appropriate for re-use and that standard renewal procedures are followed.

NOTE: The new R410a system will run at a lot higher pressure than the existing R407c system therefore it is necessary to change a setting on the outdoor unit which will restrict the running pressure to the lower value associated with R407c refrigerant. As a further fail safe it is recommended to replace the high pressure switch, the part number for this is CZ-PSWK2.

Please be advised that when replacing Sanyo outdoor unit with any U-***MF3E8 outdoor unit. It is necessary to take into consideration that the discharge pipe length is required for additional refrigerant charge.

Local and System Controls

Controls	Sanyo Reference	Panasonic Equivalent
Wired RC	RCS-TM80BG	CZ-RTC5B
Schedule timer	SHA-TM64AGB	CZ-ESWC2
System controller	SHA-KC64AGB	CZ-64ESMC2
On/Off controller	SHA-KC16KAGB	CZ-ANC2
Intelligent controller	SHA-KT256EG	CZ-256ESMC2
Communication Adaptor connector	SHA-KA128AGB	CZ-CFUNC2
Seri-Para I/O unit for outdoor	ACC-XSP4U1GB	CZ-CAPDC2
Interface Adaptor	SHA-KL4UGB	CZ-CAPC2
Seri-Para I/O unit for each I/U	ACC-SP1AGB	CZ-CAPBC2
Lon Works Interface	SHA-LN16UGB	CZ-CLNC2
WEB INTERFACE	SHA-KW64EG	CZ-CWEBC2

All local controls work via the same 2 core cable as current Panasonic controllers meaning they can easily be replaced for new controllers. The appearance of the new Panasonic controls have changed and also not all of the new features will work on existing Sanyo equipment (i.e. energy monitoring on CZ-RTC5B). The same applies for system controls and other interfaces which operate using 2 core communications (U1,U2) therefore new replacements are compatible just some of the new features may not be available.

Heat Recovery Boxes

Sanyo Reference	Panasonic Equivalent
ATK-RZP56BGWB	CZ-P56HR3
ATK-RZP56BG	CZ-P56HR3
ATK-ZP80UG	CZ-P56HR3
ATK-RZP160BGWB	CZ-P160HR3
ATK-RZP160BG	CZ-P160HR3
ATK-ZP140UG	CZ-P160HR3
ACC-3WAY-AGB	CZ-CAPE2
ACC-3WAY-AG	CZ-CAPE2
CR-3WAY-TG	CZ-CAPE2

Care must be taken when replacing SVK boxes due to variation of wirings. The Sanyo kit used a cable with additional connectors. Please check wiring and spare parts for differences.

The above is for guidance only, please contact your usual sales representative before proceeding with Sanyo replacement for up to date advice.

Cassette 60x60	Floor	Chassis	Slim Duct	1 Way Cass.	2 Way Cass.
XM***XH	FR***GXH56	FMR***GXH56	US***XH	LDR***GXH56	—
XMR***EXH56	FR***GXH56	FMR***GXH56	FUR***EXH56	LDR***GXH56	—
—	FR***GXH56	FMR***GXH56	—	LDR***GXH56	SR***GXH56
S-22MY2E5B	S-22MP1E5	S-22MR1E5	S-22MM1E5B	—	S-22ML1E5
S-28MY2E5B	S-28MP1E5	S-28MR1E5	S-28MM1E5B	S-28MD1E5	S-28ML1E5
S-36MY2E5B	S-36MP1E5	S-36MR1E5	S-36MM1E5B	S-36MD1E5	S-36ML1E5
S-45MY2E5B	S-45MP1E5	S-45MR1E5	S-45MM1E5B	S-45MD1E5	S-45ML1E5
S-56MY2E5B	S-56MP1E5	S-56MR1E5	S-56MM1E5B	S-56MD1E5	S-56ML1E5
—	S-71MP1E5	S-71MR1E5	—	S-73MD1E5	S-73ML1E5
—	—	—	—	—	—
—	—	—	—	—	—
—	—	—	—	—	—

3 Series Indoor Units: When using a current Panasonic R410a outdoor and mixing the current Panasonic indoors with 3 series Sanyo indoor units on the same system, you will need to access the detailed settings to change code 15 to 0029 on the Sanyo indoor units. To amend the setting you will need a standard controller CZ-RTC4 or CZ-RTC5 and a maintenance cable PAW-MRC which allows you to plug the controller on the outdoor PCB. Once connected follow the procedure below to change the code.

Please contact Panasonic Technical Department before proceeding.

Notes

A large grid of small dots for taking notes, arranged in approximately 30 columns and 40 rows.

Notes

A large grid of small dots, intended for taking notes.

Panasonic Heating & Cooling Solutions customer service

If your end customer is seeking further support from Panasonic directly, please forward the following ways to contact us:

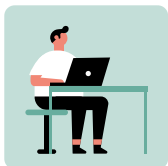

Use our European website www.aircon.panasonic.eu for contacting us. Panasonic has implemented a new contact page on the Panasonic Heating and Cooling Solutions website for potential or existing Panasonic customers.



Another option is to contact the highly experienced teams at the Panasonic call centres, who are more than qualified to support Panasonic clients in 13 different languages across Europe.

Our Call Centres in Europe for End Customers

Country	Phone number	Opening times
Belgium	+32 2 320 55 38	Mo-Fr 9-17h
Denmark	+45 89 87 45 00	Mo-Fr 9-17h
Finland	+35 8646041590	Mo-Fr 9-17h
France	0800 805 215	Mo-Fr 9-17h
Germany	+49 611 71187211	Mo-Sat 7-18h
Hungary	+36 1 700 89 65	Mo-Fr 9-17h
Ireland	1800 939 977	Mo-Fr 9-17h
Italy	+39 2 6433235	Mo-Fr 9-17h
Luxembourg	+32 2 320 55 38	Mo-Fr 9-17h
Netherlands	+31 73 6402 538	Mo-Sat 7-18h

Country	Phone number	Opening times
Norway	+47 69 67 61 00	Mo-Fr 9-17h
Poland	800 080 911	Mo-Fr 9-17h
Portugal	800 78 22 20	Mo-Fr 9-17h
Spain	+34 900 828 787	Mo-Fr 9-17h
Sweden	+46 85 221 81 00	Mo-Fr 9-17h
Switzerland DE	+41 415615366	Mo-Fr 9-17h
Switzerland FR	+41 435880049	Mo-Fr 9-17h
Switzerland IT	+41 435880048	Mo-Fr 9-17h
United Kingdom	0808 208 2115	Mo-Fr 9-17h



www.panasonic.co.uk/aircon

heating & cooling solutions

Due to the ongoing innovation of our products, the specifications of this catalogue are valid barring typographic errors, and may be subject to minor modifications by the manufacturer without prior warning in order to improve the product. The total or partial reproduction of this catalogue is prohibited without the express authorisation of Panasonic Marketing Europe GmbH.

Panasonic®

To find out how Panasonic cares for you, log on to:
www.panasonic.co.uk/aircon

General requests:
Email: uk-aircon@eu.panasonic.com

Sales administration team:
Email: uk-aircon-salesadmin@eu.panasonic.com

Technical service team:
Email: uk-aircon-tech@eu.panasonic.com
UK Office : +44 (0) 1344 853393

Heating & Cooling Solutions.
Panasonic Appliances Air Conditioning Europe (PAPAEU).
Panasonic UK, a branch of Panasonic Marketing Europe GmbH.
Registered Office: Building 3, Albany Place, Hydeway, Welwyn Garden City, AL7 3BT



Do not add or replace refrigerant other than the specified type. Manufacturer is not responsible for the damage and deterioration in safety due to usage of the other refrigerant.
The outdoor units in this catalogue contains fluorinated greenhouse gases with a GWP higher than 150.

