

SAMSUNG

VRF Technical Data Book

Hydro Unit HT for Europe



Model : AM***TNBF*B/EU

History

* 3@7<	! =2771/87<	~ /B3	&3; /@
Ver.1.0	Release the VRF Hydro Unit HT TDB for Europe	20.09.18	

Nomenclature

Indoor Unit

Model Name

AM	160	T	N	B	F	E	B	/	EU
(1)	(2)	(3)	(4)	(5)	(6)	(7)	(8)		Buyer

(1) Classification

AM	DVM
----	-----

(5) Product Notation

B	HYDRO UNIT
---	------------

(2) Capacity

X 1/10 kW (3 digits)

(6) Feature

F	CASCADE
---	---------

(3) Version

T	2020
---	------

(7) Rating Voltage

A	115V, 60hz, 1Φ
B	220V, 60Hz, 1Φ
C	208~230V, 60Hz, 1Φ
D	200~220V, 50Hz, 1Φ
E	220~240V, 50Hz, 1Φ
F	208~230V, 60Hz, 3Φ
G	380~415V, 50Hz, 3Φ

(4) Product Type

X	Outdoor Unit
N	Indoor Unit

(8) Mode

B	Heat Pump (R134A)
---	-------------------

Features & Benefits

Hydro Unit

Stay cooler, warmer, and supply hot water

Designed for large buildings, such as hotels, offices and hospitals, the new Samsung DVM Hydro system is a versatile and efficient air cooling and heating system that also supplies hot water. Improving on conventional systems, its integrated design ensures that heat is effectively recovered and recycled, providing a high Coefficient of Performance (COP), while also enabling outstanding manageability with just one control system for everything.



Integrated Solution Easy & Simple Connection Integrated Control

Altogether easier and more efficient

The Samsung DVM Hydro system is compatible with all DVM S Outdoor units and can be added to create a single, integrated solution for heating and hot water that's simple to manage. So it ensures much greater efficiency to suit a variety of demands by recycling redundant heat and transferring it to other areas where it is needed – generating substantial energy and cost savings all year round.

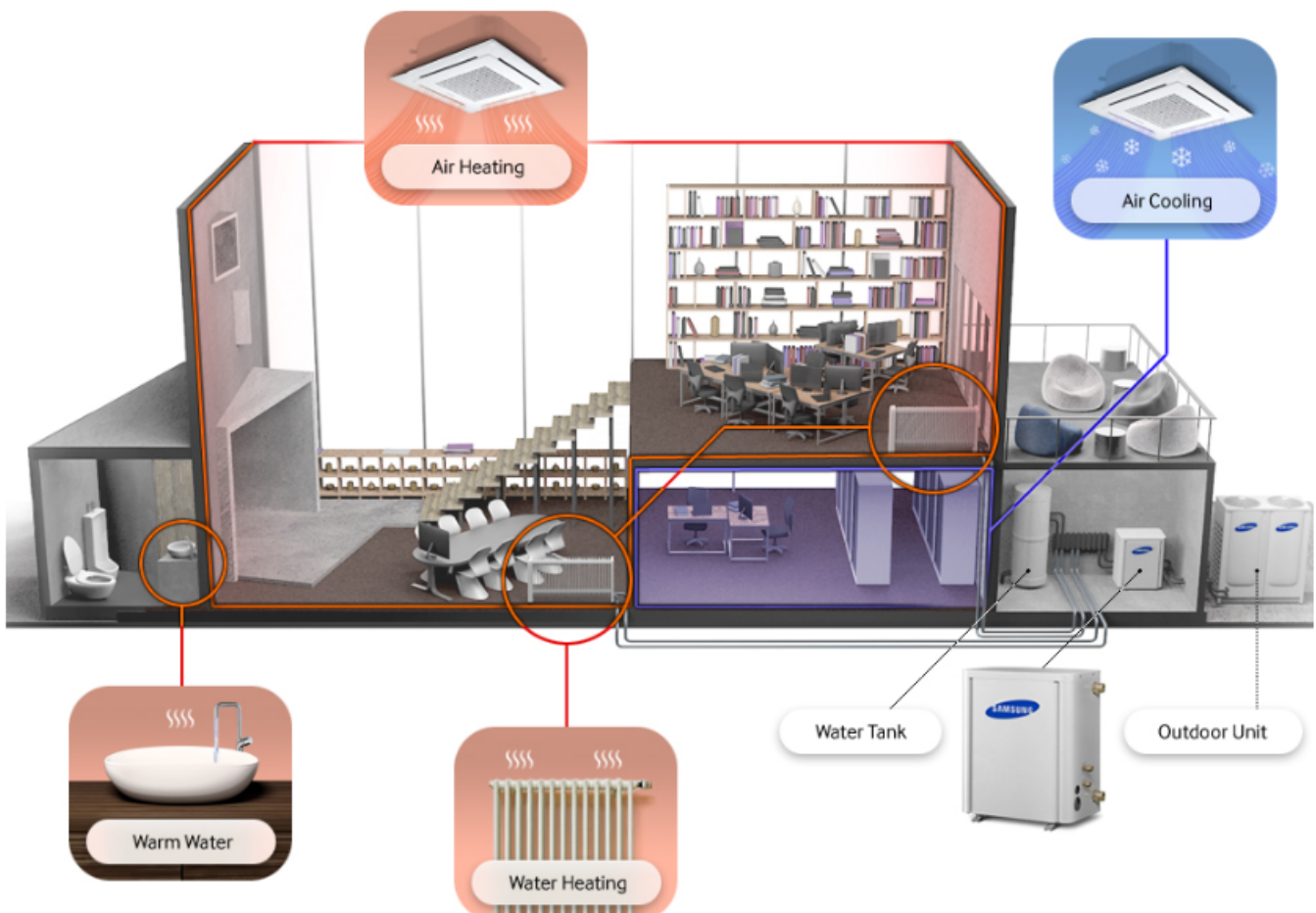

Contents

1. Line up	6
2. Specification	7
3. Summary Table	9
4. Capacity Table	10
5. Capacity correction	13
6. Dimensional Drawing	15
7. Electrical Wiring Diagram	17
8. Sound Data	19
9. Operation range	20
10. Piping Diagram	21
11. Hydraulic Performance	22
12. Installation	23

1. Line up

Hydro Unit

Capacity	16kW		25kW	
Image				
Model	AM160TNBFEB/EU	AM160TNBFGB/EU	AM250TNBFEB/EU	AM250TNBFGB/EU

2. Specifications

Model				AM160TNBFEB/EU	AM250TNBFEB/EU	
Power Supply			Φ, #, V, Hz	1,2,220-240,50	1,2,220-240,50	
Mode			-	HP/HR	HP/HR	
Performance	Capacity (Nominal)	Cooling 2)	kW	-	-	
			Btu/h	-	-	
		Heating 2)	kW	16	25	
			Btu/h	54,600	85,300	
Power	Power Input (Nominal)	Cooling 1)	W	-	-	
		Heating 2)		3100	5000	
	Current Input (Nominal)	Cooling 1)	A	-	-	
		Heating 2)		14.3	23.1	
	MCA				18.0	30.0
	MFA				25	40
Compressor	Type		-	Rotary	Rotary	
	Output		kW × n	-	-	
	Model Name		-	UX5T250FNBEX	UX5T250FNBEX	
	Oil	Type	-	POE	POE	
		Initial Charge	cc	1,700	1,700	
Heat exchanger	Type		-	PHE	PHE	
	Quantity		-	2	2	
	Pipe size		Inch	PT1 (25A)	PT1 (25A)	
	Water flow tare		LPM	23	36	
	Flow Switch		LPM	12	12	
Option Code			-	01104C-105000-20A0A0-332200	01104C-105000-20FAFA-332100	
Piping Connections	Liquid Pipe	Φ,mm		9.52	9.52	
		Φ, inch		3/8	3/8	
	Gas Pipe	Φ,mm		15.88	15.88	
		Φ, inch		5/8	5/8	
Field Wiring	Power Source Wire (L<10m, Single Installation)		mm ²	4.0	4.0	
	Transmission Cable	Min.	mm ²	0.75	0.75	
Refrigerant	Type		-	R-134a	R-134a	
	Control Method		-	EEV	EEV	
	Factory Charging		kg / tCO ₂ e	2.15 / 3.07	2.15 / 3.07	
Sound	Sound Pressure	H / M / L	dB(A)	42.0/-/-	42.0/-/-	
Dimensions	Net Weight		kg	105.0	105.0	
	Shipping Weight		kg	112.5	112.5	
	Net Dimensions (W×H×D)		mm	518 x 1,210 x 330	518 x 1,210 x 330	
	Shipping Dimensions (W×H×D)		mm	652 x 1,374 x 426	652 x 1,374 x 426	
Operating Temp. Range	Ambient	Cooling	°C	-	-	
		Heating	°C	-20~43	-20.0 ~ 35	
		Hot water	°C	-20~43	-20~43	
	Leaving Water	Cooling	°C	-	-	
		Heating	°C	25~80	25~80	

* Specifications may be subject to change without prior notice for product improvement.

* 1) Nominal cooling capacities are based on;

- Water temperature : 23°C inlet, 18°C outlet - Indoor temperature : 27°C DB, 19°C WB - Outdoor temperature : 35°C DB, 24°C WB

* 2) Nominal heating capacities are based on; - Water temperature : 55°C inlet, 65°C outlet -Indoor temperature : 20°C DB

- Outdoor temperature : 7°C DB, 6°C WB

* 3) Sound pressure was acquired in an anechoic room. Thus actual noise level may be different depending on the installation conditions.

*4) These products contain R410A which is fluorinated greenhouse gas.

* Heat Exchanger type : Plate Heat Exchanger (STS)

*5) These products contain R134a(GWP=1,430) which is fluorinated greenhouse gas.

2. Specifications

Model				AM160TNBFGB/EU	AM250TNBFGB/EU	
Power Supply			Φ, #, V, Hz	3,4,380-415,50	3,4,380-415,50	
Mode			-	HP/HR	HP/HR	
Performance	Capacity (Nominal)	Cooling 2)	kW	-	-	
			Btu/h	-	-	
		Heating 2)	kW	16	25	
			Btu/h	54,600	85,300	
Power	Power Input (Nominal)	Cooling 1)	W	-	-	
		Heating 2)		3100	5000	
	Current Input (Nominal)	Cooling 1)	A	-	-	
		Heating 2)		4.85	7.85	
	MCA				16.1	16.1
	MFA				20	20
Compressor	Type		-	Rotary	Rotary	
	Output		kW × n	-	-	
	Model Name		-	UX5T250FNBEX	UX5T250FNBEX	
	Oil	Type	-	POE	POE	
Initial Charge		cc	1,700	1,700		
Heat exchanger	Type		-	PHE	PHE	
	Quantity		-	2	2	
	Pipe size		Inch	PT1 (25A)	PT1 (25A)	
	Water flow tare		LPM	23	36	
	Flow Switch		LPM	12	12	
Option Code			-	01104C-105000-20A0A0-332200	01104C-105000-20FAFA-332100	
Piping Connections	Liquid Pipe		Φ,mm	9.52	9.52	
			Φ, inch	3/8	3/8	
	Gas Pipe		Φ,mm	15.88	15.88	
			Φ, inch	5/8	5/8	
Field Wiring	Power Source Wire (L<10m, Single Installation)		mm ²	2.5	2.5	
	Transmission Cable	Min.	mm ²	0.75	0.75	
Refrigerant	Type		-	R-134a	R-134a	
	Control Method		-	EEV	EEV	
	Factory Charging		kg / tCO2e	2.15 / 3.07	2.15 / 3.07	
Sound	Sound Pressure	H / M / L	dB(A)	42.0/-/-	42.0/-/-	
Dimensions	Net Weight		kg	103.5	103.5	
	Shipping Weight		kg	111.0	111.0	
	Net Dimensions (W×H×D)		mm	518 x 1,210 x 330	518 x 1,210 x 330	
	Shipping Dimensions (W×H×D)		mm	652 x 1,374 x 426	652 x 1,374 x 426	
Operating Temp. Range	Ambient	Cooling	°C	-	-	
		Heating	°C	-20~43	-20~43	
		Hot water	°C	-20~43	-20~43	
	Leaving Water	Cooling	°C	-	-	
		Heating	°C	25~80	25~80	

* Specifications may be subject to change without prior notice for product improvement.

* 1) Nominal cooling capacities are based on;

- Water temperature : 23°C inlet, 18°C outlet - Indoor temperature : 27°C DB, 19°C WB - Outdoor temperature : 35°C DB, 24°C WB

* 2) Nominal heating capacities are based on; - Water temperature : 55°C inlet, 65°C outlet - Indoor temperature : 20°C DB

- Outdoor temperature : 7°C DB, 6°C WB

* 3) Sound pressure was acquired in an anechoic room. Thus actual noise level may be different depending on the installation conditions.

* 4) These products contain R410A which is fluorinated greenhouse gas.

* Heat Exchanger type : Plate Heat Exchanger (STS)

* 5) These products contain R134a(GWP=1,430) which is fluorinated greenhouse gas.

3. Summary Table

Hydro Unit

Electrical characteristics

Capacity [kW]	Model	Power Supply				Voltage Range [V]		Nominal Running Current [A]	Current [A]	
		Φ	#	Hz	Voltage	Min. (-10%)	Max. (+10%)	Heating	MCA	MFA
16	AM160TNBFEB/EU	1	2	50	220-240	198	264	14.3	18.0	25
16	AM160TNBFGB/EU	3	4	50	380-415	342	456	4.85	16.1	20
25	AM250TNBFEB/EU	1	2	50	220-240	198	264	23.1	30.0	40
25	AM250TNBFGB/EU	3	4	50	380-415	342	456	7.85	16.1	20

NOTE

- MCA : Minimum circuit amperes
- MFA : Maximum fuse amperes
- Select wire size based on the value of MCA

4. Capacity table

1) Heating

Ta : Ambient temperature, HC : Heating Capacity(W), PI : Power Input(W)
 LW : Leaving Water temperature, EW : Entering Water temperature

Model	Ta	LW[°C]		LW[°C]		LW[°C]		LW[°C]	
		45		55		65		75	
	[°C DB]	HC	PI	HC	PI	HC	PI	HC	PI
160	-20	15,000	2,062	15,000	2,017	15,000	2,523	14,000	3,193
	-17	15,000	2,083	15,000	1,952	15,000	2,357	14,500	3,063
	-15	15,500	2,313	15,500	2,007	15,500	2,435	15,000	2,895
	-7	15,500	2,305	16,000	2,185	16,000	2,598	15,500	2,956
	-3	16,000	2,352	16,000	2,380	16,000	2,560	16,000	3,087
	1	16,000	2,146	16,000	2,363	16,000	2,501	16,000	3,052
	3	16,000	2,041	16,000	2,314	16,000	2,453	16,000	2,963
	7	16,000	1,868	16,000	2,281	16,000	2,419	16,000	2,828
	11	16,000	1,850	16,000	2,279	16,000	2,428	16,000	2,763
	15	16,000	1,806	16,000	2,259	16,000	2,474	16,000	2,734
	20	16,000	1,784	16,000	2,232	16,000	2,444	16,000	2,701
	25	16,000	1,763	16,000	2,205	16,000	2,415	16,000	2,668
	30	16,000	1,741	16,000	2,178	16,000	2,385	16,000	2,636
35	16,000	1,719	16,000	2,151	16,000	2,355	16,000	2,603	
250	-20	23,000	4,460	23,000	4,734	22,000	5,017	21,500	5,424
	-17	23,500	4,333	23,500	4,563	23,500	4,802	22,500	5,159
	-15	24,000	4,287	24,500	4,456	24,500	4,670	23,500	4,996
	-7	24,500	3,878	25,000	4,084	25,000	4,235	24,000	4,442
	-3	25,000	3,736	25,000	3,933	25,000	4,073	24,500	4,226
	1	25,000	3,616	25,000	3,803	25,000	3,948	25,000	4,051
	3	25,000	3,565	25,000	3,747	25,000	3,900	25,000	3,979
	7	25,000	3,443	25,000	3,652	25,000	3,831	25,000	3,865
	11	25,000	3,417	25,000	3,580	25,000	3,799	25,000	3,791
	15	25,000	3,400	25,000	3,530	25,000	3,798	25,000	3,758
	20	25,000	3,359	25,000	3,488	25,000	3,752	25,000	3,713
	25	25,000	3,318	25,000	3,445	25,000	3,707	25,000	3,668
	30	25,000	3,278	25,000	3,403	25,000	3,661	25,000	3,623
35	25,000	3,237	25,000	3,360	25,000	3,616	25,000	3,578	

EW: Entering Water temperature	EW = 40°C	EW = 45°C	EW = 55°C	EW = 65°C
Leaving Water temperature - Entering Water temperature	ΔT=5°C	ΔT=10°C	ΔT=10°C	ΔT=10°C

Conditions

- ΔT = Leaving Water temperature - Entering Water temperature
- No pump power input is included.
- Equivalent piping length = 7.5m
- Ta < 0 °C : RH=75%, Ta > 0 °C : RH=85%

4. Capacity table

2) Capacity calculation method

How to calculate heating capacity and power input : Combination of outdoor unit and hydro unit HT

- Heating capacity and power input of hydro unit HT : refer to the indoor unit capacity table.
- Power input of outdoor unit : refer to the outdoor unit capacity table (indoor 20°C DB).

Example

- Standard condition: Outdoor 7°C DB/6°C WB, Indoor 20°C DB
- Water condition: EW 55°C, LW 65°C

8HP DVM S TDB Heat Capacity Table

combination, % (Capacity index)	Outdoor Temperature(°C)		Indoor Temperature (°C,DB)	
			20.0°C	
	DB	WB	TC kW	PI kW
100%	-20	-21	19.8	7.80
	-17	-18	20.9	7.96
	-15	-16	22.0	8.04
	-12	-13	22.9	7.92
	-10	-11	23.9	7.68
	-7	-8	24.4	7.21
	-5	-6	25.2	6.84
	-3	-4	25.2	6.21
	0	-1	25.2	5.84
	3	2	25.2	5.52
	5	4	25.2	5.23
	7	6	25.2	5.10
	9	8	25.2	4.85
	11	10	25.2	4.63
13	12	25.2	4.42	
15	14	25.2	4.27	

Combination 1 (Outdoor Unit 8HP + Indoor Unit 8HP)

Indoor Heat Capa.[kW]	25	= HT Capacity Table
PI Indoor Unit(8HP)[kW]	3.831	= HT Capacity Table (Ref. P.10)
PI Outdoor Unit(8HP)[kW]	5.10	----- Outdoor Unit Capacity Table
PI System[kW]	8.93	=Indoor Unit PI + Outdoor Unit PI

4. Capacity table

10HP DVM S TDB Heat Capacity Table

combination, % (Capacity index)	Outdoor Temperature(°C)		Indoor Temperature (°C,DB)	
			20.0 °C	
	DB	WB	TC kW	PI kW
100%	-20	-21	26.5	10.24
	-17	-18	28.1	10.45
	-15	-16	29.1	10.67
	-12	-13	29.7	10.62
	-10	-11	30.7	10.40
	-7	-8	31.2	9.57
	-5	-6	31.5	8.99
	-3	-4	31.5	8.15
	0	-1	31.5	7.68
	3	2	31.5	7.25
	5	4	31.5	6.88
	7	6	31.5	6.70
	9	8	31.5	6.38
	11	10	31.5	6.08
	13	12	31.5	5.81
15	14	31.5	5.61	

Combination 1 (Outdoor Unit 10HP + Indoor Unit 5HP x 2ea)

Indoor Heat Capa.[kW]	16	= HT Capacity Table (Ref. P.10)
Indoor Heat Capa.[kW]	32	= 2 x 5HP
PI Indoor Unit(5HP)[kW]	2.419	= HT Capacity Table (Ref. P.10)
PI Total Indoor Unit[kW]	4.838	= 2 x 5HP
PI Outdoor Unit(10HP)[kW]	6.70	----- Outdoor Unit Capacity Table
PI System[kW]	11.54	= Total Indoor Unit PI + Outdoor Unit PI

Flowrate Information

Flowrate[l/min]	**160**	**250**
ΔT = 15°C	15.4	24.1
ΔT = 10°C	23.0	36.0
ΔT = 5°C	46.0	72.0

5. Capacity correction

How to calculate heating capacity and power input : Integrated value

1. Defrosting correction factor (Outdoor unit)

- On heating operation, frost can be formed on heat exchanger according to outdoor temperature. (Frost on heat exchanger results in decreasing the performance.)
To remove frost on heat exchanger of outdoor unit, defrost operation is carried out periodically.
During defrost operation, capacity of outdoor unit may decrease.
The decrement is not considered to the individual capacity tables.

Outdoor temperature (°C, DB)	-10	-8	-6	-4	-2	0	3	5	7
Capacity coefficient	0.98	0.97	0.95	0.93	0.88	0.85	0.86	0.91	1

Corrected Heating Capacity = heating capacity x Capacity coefficient

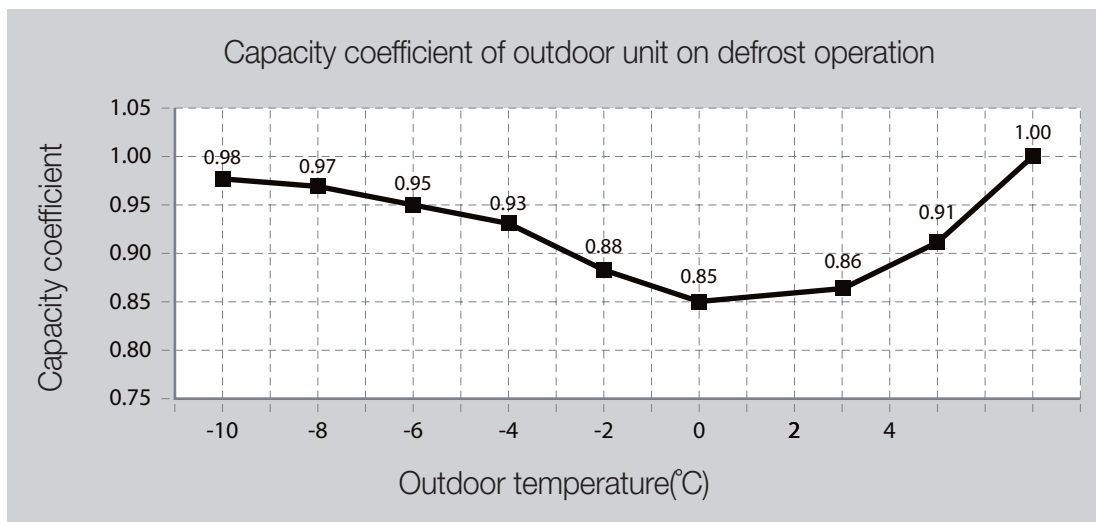

2. Power input of hydro unit HT during defrost operation

	Power Input (W)
HT 5HP	1050
HT 8HP	1500

3. Capacity correction factor of hydro unit HT during defrost operation

	HT Capa Correction Factor
HT 5HP	0.3
HT 8HP	

※ In case of the defrosting interval, it discharges the heat as much as (rated capacity x correction factor). [Water temp. Drop]
ex) HT 5HP HT 5HP defrosting capacity = -16kW*0.3 = -4.8kW

5. Capacity correction

Example) Combination: 10HP DVM S + 5HP HT X 2ea, Outdoor 5°C DB, EW/LW=55°C/65°C

- 1) Defrosting correction factor (Outdoor unit, 5°C) = 0.91
- 2) Capacity correction factor (Hydro unit HT) = 0.3
- 3) Integrated capacity correction factor = $0.91 - (1 - 0.91) \times 0.3 = 0.883$
- 4) HC = $0.883 \times 16,000W \times 2ea = 28.3kW$
- 5) Power input (Outdoor unit) = 6.88kW
- 6) Power input (Hydro unit HT) = $\{ 0.91 \times (2,453W + 2,419W) / 2 + (1 - 0.91) \times 1,050W \} \times 2 = 4.62kW$
- 7) Total PI = 6.88 + 4.62 = 11.5kW

Correction Factor : Ref.P13, Hydro Unit Capacity Table : Ref.P.10

10HP DVM S TDB Heat Capacity Table

combination, % (Capacity index)	Outdoor Temperature(°C)		Indoor Temperature (°C,DB)	
			20.0 °C	
	DB	WB	TC kW	PI kW
100%	-20	-21	26.5	10.24
	-17	-18	28.1	10.45
	-15	-16	29.1	10.67
	-12	-13	29.7	10.62
	-10	-11	30.7	10.40
	-7	-8	31.2	9.57
	-5	-6	31.5	8.99
	-3	-4	31.5	8.15
	0	-1	31.5	7.68
	3	2	31.5	7.25
	5	4	31.5	6.88
	7	6	31.5	6.70
	9	8	31.5	6.38
	11	10	31.5	6.08
13	12	31.5	5.81	
15	14	31.5	5.61	

6. Dimensional Drawing

Dimensional Drawing

Units : mm

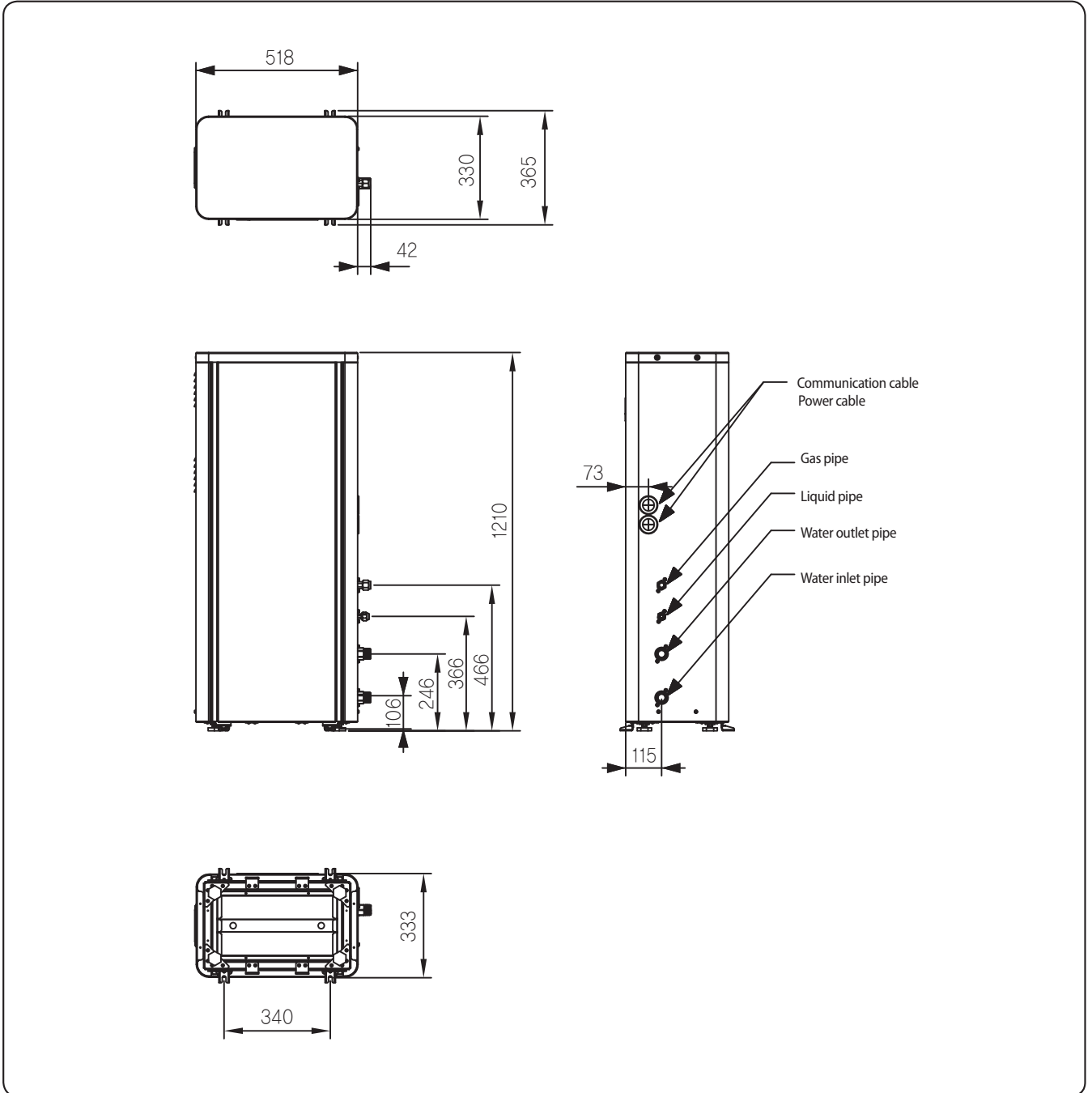

Refrigerant side	Liquid side connection part	3/8 (ø9.52)
	Gas side connection part	5/8 (ø22.23)
Water side connection part		PT 1 (25 A)

6. Dimensional Drawing

Center of gravity

Units : mm

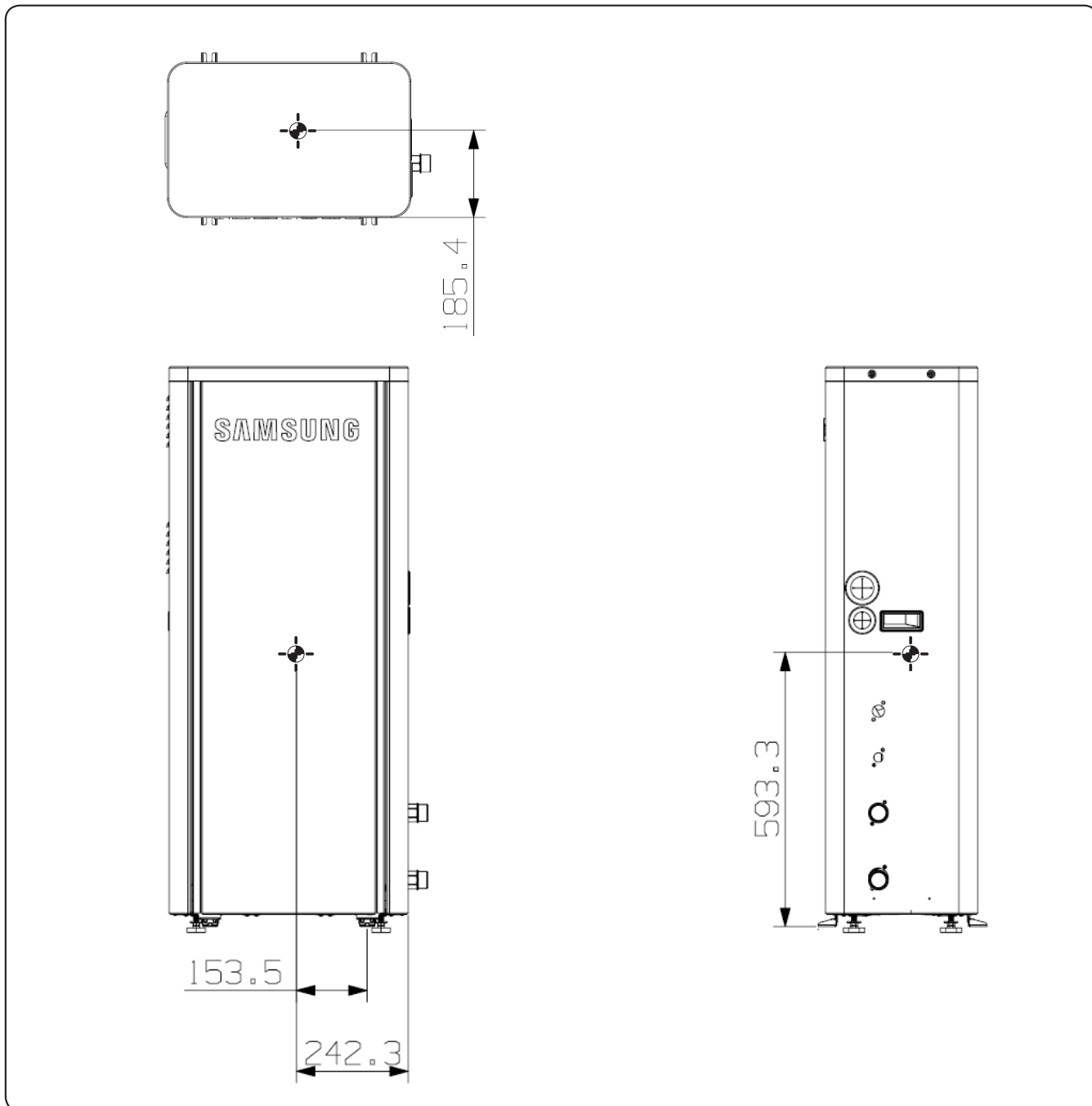

7. Electrical wiring diagram

Hydro Unit

AM160TNBFEB/EU, AM250TNBFEB/EU

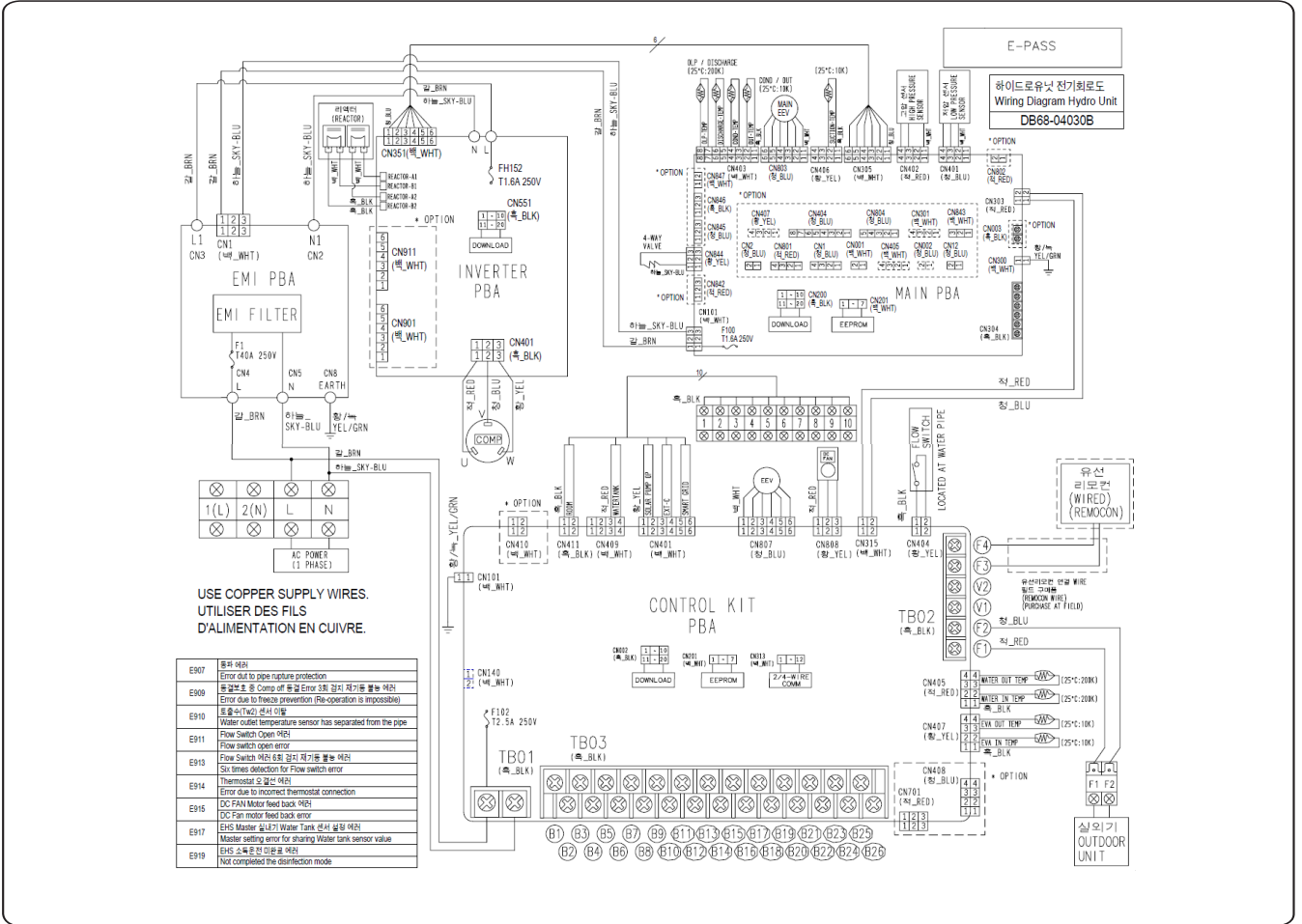

MAIN PBA	Printed circuit board (MAIN)	OLP-TEMP	Thermistor - OLP
INVERTER PBA	Printed circuit board (INVERTER)	DISCHARGE-TEMP	Thermistor – DISCHARGE
EMI PBA	Printed circuit board (EMI)	COND-TEMP	Thermistor – COND
CONTROL KIT PBA	Printed circuit board (CONTROL KIT)	OUT-TEMP	Thermistor – OUT Ambient
REACTOR	Reactor	SUCTION-TEMP	Thermistor – SUCTION
EEV	Electronic Expansion Valve	WATER OUT TEMP	Thermistor – WATER OUT
COMP	Compressor	WATER IN TEMP	Thermistor – WATER IN
HIGH PRESSURE SENSOR	HIGH PRESSURE SENSOR	EVA OUT TEMP	Thermistor – EVA OUT
LOW PRESSURE SENSOR	LOW PRESSURE SENSOR	EVA IN TEMP	Thermistor – EVA IN
4-WAY VALVE	Solenoid valve – 4-WAY		

NOTES

- This wiring diagram applies only to the indoor unit.
- Symbols show as follow;
BLK : black, RED : red, BLU : blue, WHT:white, YEL : yellow, BRN : brown, SKY : sky-blue, GRN : green
- For connection wiring indoor-outdoor transmission F1-F2, indoor-wired remotecontroller transmission F3-F4.
- ⊕: Protective earth(screw), □□□□: Connector, n_y : T

7. Electrical wiring diagram

Hydro Unit

AM160TNBFGB/EU, AM250TNBFGB/EU

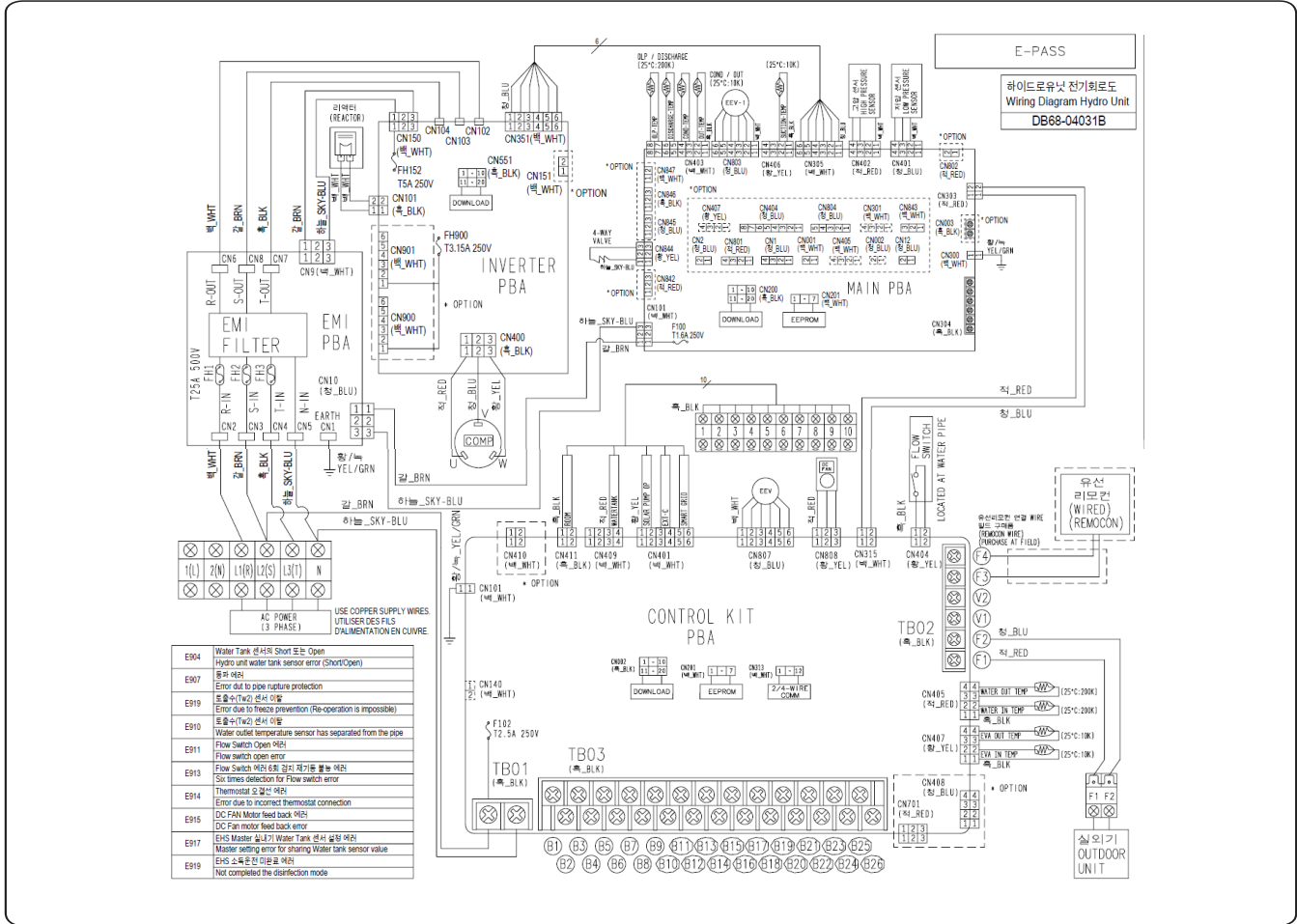

MAIN PBA	Printed circuit board (MAIN)	OLP-TEMP	Thermistor - OLP
INVERTER PBA	Printed circuit board (INVERTER)	DISCHARGE-TEMP	Thermistor – DISCHARGE
EMI PBA	Printed circuit board (EMI)	COND-TEMP	Thermistor – COND
CONTROL KIT PBA	Printed circuit board (CONTROL KIT)	OUT-TEMP	Thermistor – OUT Ambient
REACTOR	Reactor	SUCTION-TEMP	Thermistor – SUCTION
EEV	Electronic Expansion Valve	WATER OUT TEMP	Thermistor – WATER OUT
COMP	Compressor	WATER IN TEMP	Thermistor – WATER IN
HIGH PRESSURE SENSOR	HIGH PRESSURE SENSOR	EVA OUT TEMP	Thermistor – EVA OUT
LOW PRESSURE SENSOR	LOW PRESSURE SENSOR	EVA IN TEMP	Thermistor – EVA IN
4-WAY VALVE	Solenoid valve – 4-WAY		

NOTES

- This wiring diagram applies only to the indoor unit.
- Symbols show as follow;
BLK : black, RED : red, BLU : blue, WHT:white, YEL : yellow, BRN : brown, SKY : sky-blue, GRN : green
- For connection wiring indoor-outdoor transmission F1-F2, indoor-wired remotecontroller transmission F3-F4.
- ⊕: Protective earth(screw), □□□□: Connector, n / $_$: T

8. Sound Data

Hydro Unit

Sound Pressure level

Unit: dB(A)

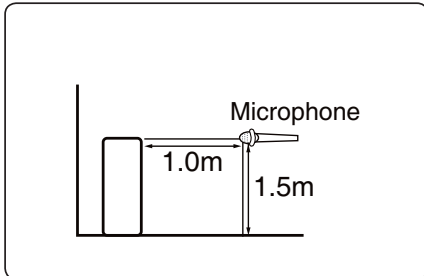

Model	Heating
AM160TNBF*B/EU	42
AM250TNBF*B/EU	42

- NC Curve

1) AM160TNBF*B/EU

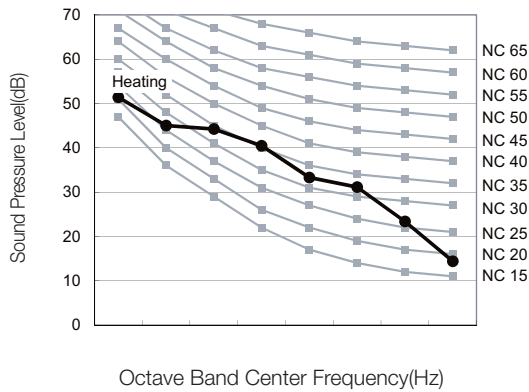

2) AM250TNBF*B/EU

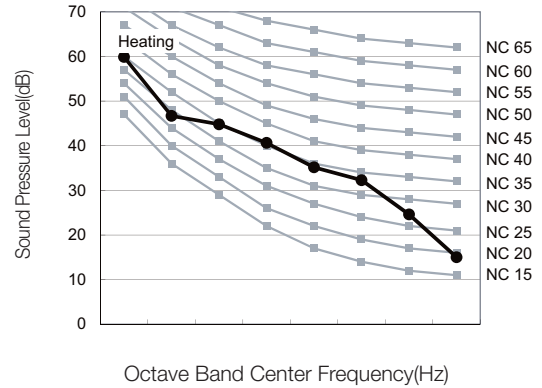

NOTE

- Specifications may be subject to change without prior notice.
- Sound pressure level is obtained in an anechoic room.
- Sound pressure level is a relative value, depending on the distance and acoustic environment.
- Sound pressure level may differ depending on operation condition.
- dB(A) = A-weighted sound pressure level
- Reference acoustic pressure 0 dB= 20 uPa

9. Operation range

Heating Operation Range

* Ta : Ambient temperature

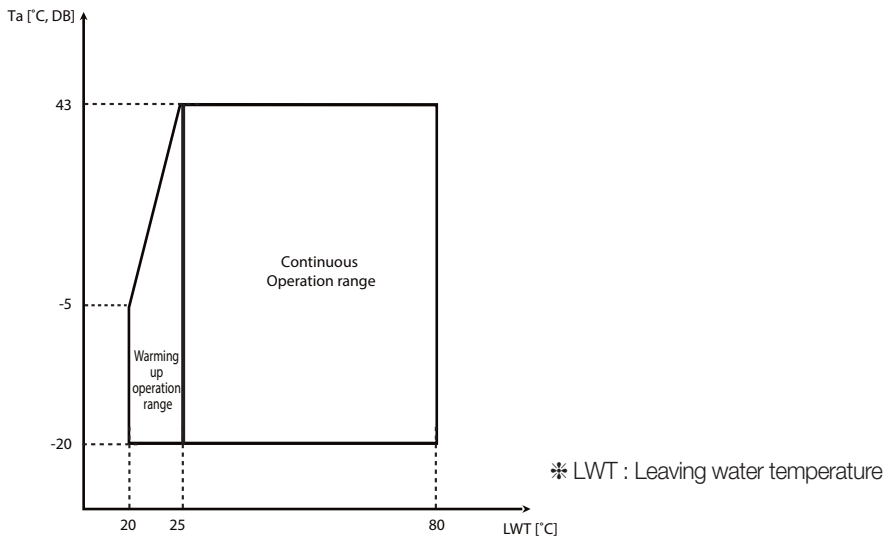

10. Piping diagram

Hydro Unit

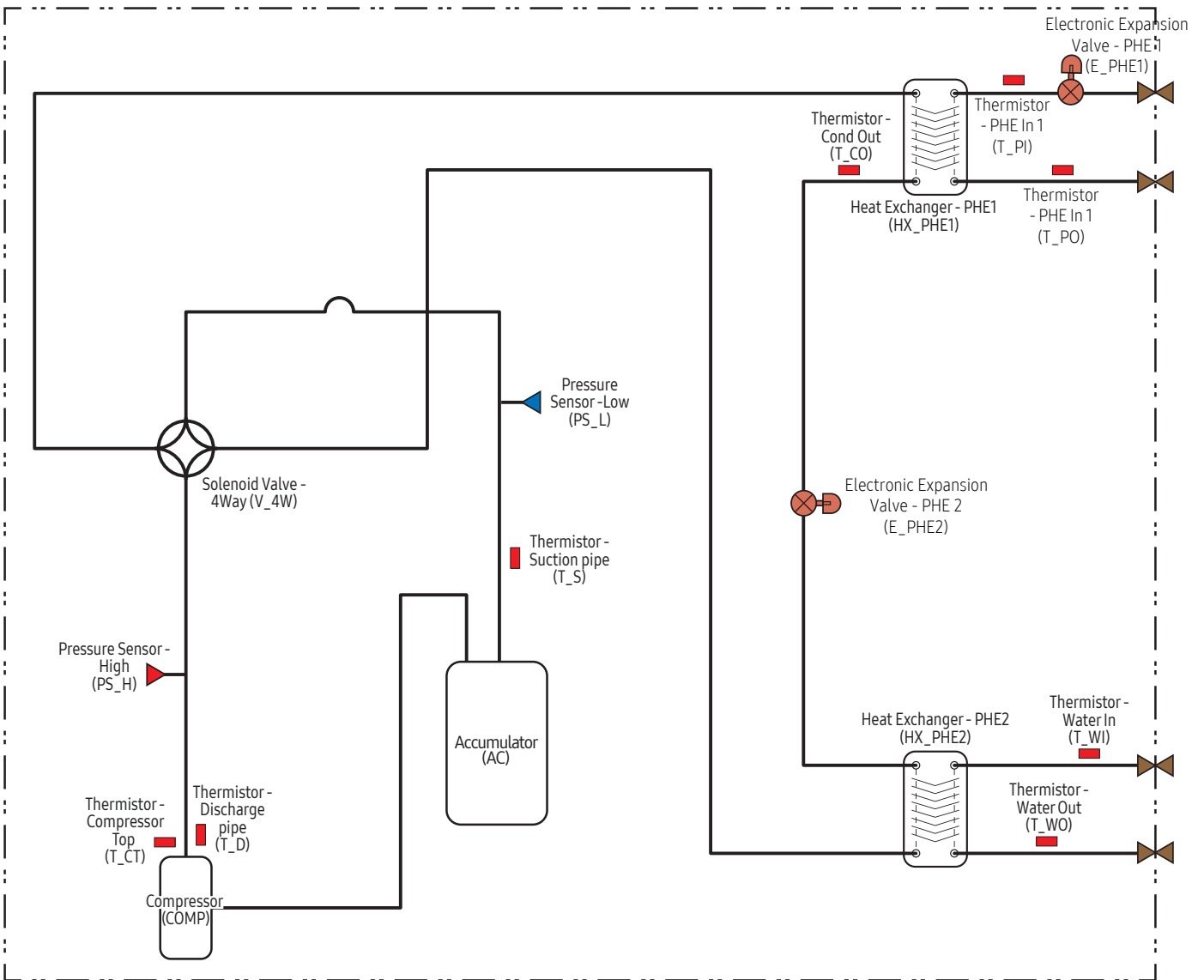

11. Hydraulic performance

Hydro Unit

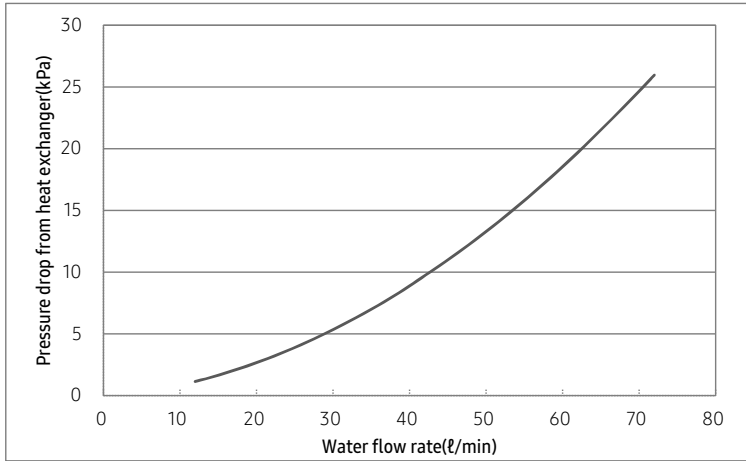

Water flow rate (LPM)	Pressure drop from heat exchanger (kPa)
12	1.1
15	1.6
20	2.7
25	3.9
30	5.3
35	7.0
40	8.9
50	13.3
60	18.5
70	24.6
72	26.0

12. Installation

Hydro Unit

Selecting installation location

- ▶ Choose a place with ventilation duct or opening to cool down the heat generated from the product and maintain the surrounding temperature within Hydro unit : 5 ~ 40 °C, humidity 80 % Hydro unit HT : 5 ~ 35 °C humidity 80 %.
- ▶ Choose a place where structure can bear the weight and vibration of the DVM Hydro unit / Hydro unit HT.
- ▶ Choose a flat place that rainwater does not settle or leak.
- ▶ Choose a well ventilated place with sufficient space for repair and other services.
- ▶ Choose a place where you can easily connect the refrigerant pipes between the DVM Hydro unit / Hydro unit HT and outdoor unit within allowable distance.
- ▶ Do not install this product in a place where it may corrode.
- ▶ Install the power cable and communication cable of the DVM Hydro unit / Hydro unit HT and outdoor unit at least 1 m away from the electric appliance such as TV. (In some cases, there may be problem even if there's more than 1m gap from the electric appliances.)

Space requirement

- ▶ When installing the product, make sure to secure minimum distance with obstacles as shown below.
- ▶ When you install one product on top of the other one, secure at least 600 mm of space on the water pipe side.

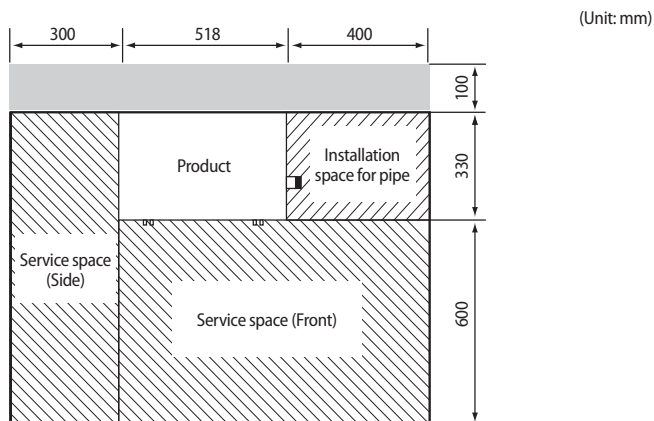

Hydro unit HT

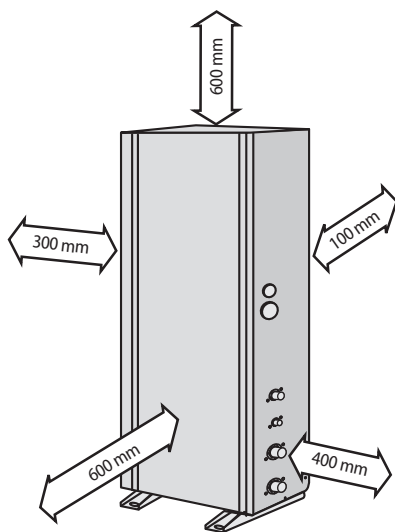

- CAUTION** | If the Hydro unit / Hydro unit HT is needed to be installed close to the walls unavoidably, prevent the vibration generated from the product to the walls with cushioning materials etc.

12. Installation

Hydro Unit

Base construction and installation of the DVM Hydro unit / Hydro unit HT



If this product is installed in residential area, apply anti-vibration product to prevent the vibration from transferring to the building.

- ▶ Manufacturer is not responsible for the damage occurred by not following the installation standards.
- 1. Considering the vibration and weight of the DVM Hydro unit / Hydro unit HT, strength of the base ground must be strong enough to prevent noise and the top part of the base ground has to be flat.
- 2. Base ground should be 1.5 times larger than the bottom of the Hydro unit.
- 3. It is necessary to add wire mesh or steel bar during concrete construction for the base ground to prevent damages or cracks.
- 4. Place the DVM Hydro unit / Hydro unit HT on the base construction and completely fix it with the bolt, nut and washer. (The bearing force has to be over 3.5 kN)
- 5. Fix the DVM Hydro unit / Hydro unit HT firmly with 4 foundation bolts.
- 6. When concrete construction for DVM Hydro unit / Hydro unit HT installation is completed, install an anti-vibration pad($t=20$ mm or more) or an anti-vibration frame(vibration transmissibility=5 % and below) to prevent vibration of the outdoor unit from transferring to the base ground.
- 7. When constructing base ground, DVM Hydro unit / Hydro unit HT must be supported within the range of following dimensions.

Base ground construction

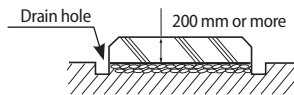

DVM Hydro unit HT installation

Considering the vibration and weight of the DVM Hydro unit HT, strength of the base ground must be strong enough to prevent noise and the top part of the base ground has to be flat.

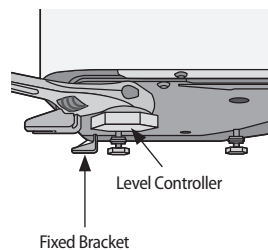

Adjust the level controller to make fixed controller has to be min. 10 mm higher than level controller.

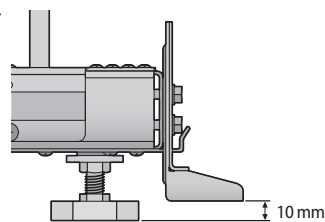

Place the DVM Hydro unit HT on the base construction and completely fix it with the foundation bolt(M10), nut and washer. The recommended length of foundation bolts are over 20 mm from the base ground.

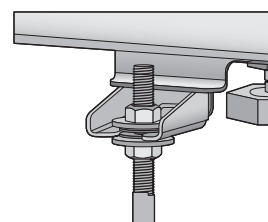

< A method of fixing the bracket >

12. Installation

Hydro Unit

Base construction and installation of the DVM Hydro unit HT

Anchor specification

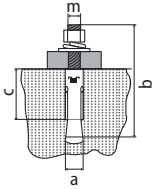

Size	Diameter of drill bit (a)	Anchor length (b)	Sleeve length (c)	Insert depth	Fastening torque
M10	14 mm	75 mm	40 mm	50 mm	30 N·m

Dimension of the Hydro unit HT

(Unit: mm)

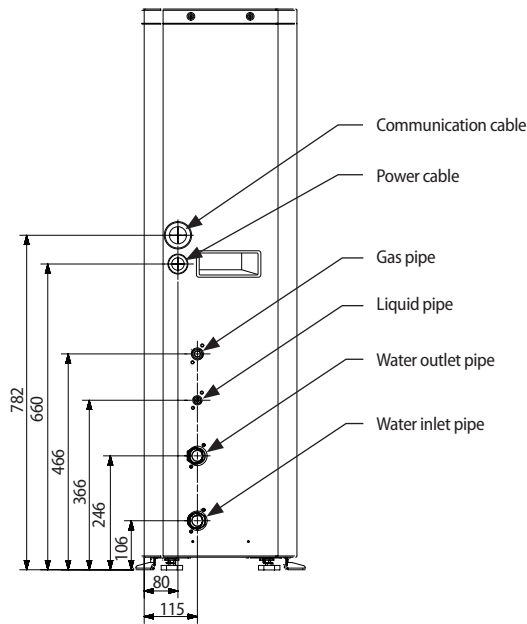
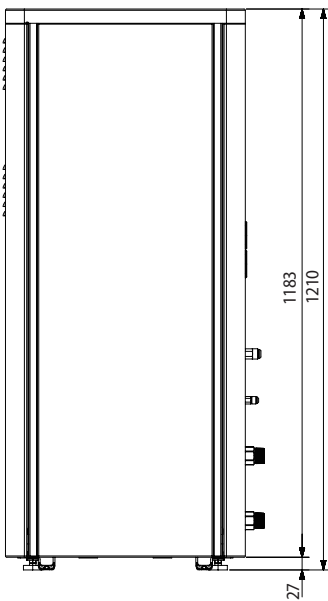
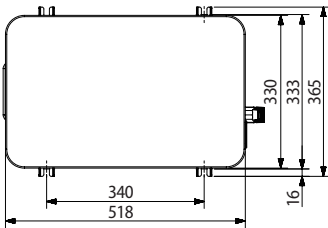

Model of the Hydro unit		AM***FNBF*B AM***TNBF**
Refrigerant side	Liquid side connection part	3/8" (ø9.52)
	Gas side connection part	5/8" (ø15.88)
Water side connection part		PT 1(25A)

12. Installation

Hydro Unit

Refrigerant pipe installation

Refrigerant pipe work

- ▶ Use exclusive tools and accessories for R-410A to respond to pressure of the R-410A and prevent foreign substances from entering into the pipes.
- ▶ The length of refrigerant pipe should be as short as possible and the height difference between the DVM Hydro unit / Hydro unit HT and outdoor unit should be minimized.
- ▶ Piping work must be done within allowable piping length, height difference, and the allowable length after branching.
- ▶ The pressure of the R-410A is high. Use only certified refrigerant pipe and follow the installation method.
- ▶ Use clean refrigerant pipe and there shouldn't be any harmful ion, oxide, dust, iron content or moisture inside pipe.
- ▶ Pipe work must be done aside from the product.
- ▶ After completing the pipe installation, calculate the additional amount of refrigerant according to method of each indoor units and make sure to use R-410A refrigerant when charging. (Color of the R-410A refrigerant container is painted in pink.)

Model name of DVM Hydro unit	AM***TNBF**
Amount of additional refrigerant	0.6 kg

- ▶ Do not use Flux when welding the refrigerant pipes.



- In case the capacity conjunction of the Hydro Unit HT exceeds 50 % among the total indoor unit, please don't put the additional refrigerant.
- When operate Hydro unit HT to add R-410A refrigerant at the outdoor unit side, Hydro unit HT will not work for cooling refrigerant charging operation if water temperature is under 33°C. Perform heating refrigerant charging operation or perform cooling refrigerant charging operation after warming water up over 33°C.
- When operate Hydro unit HT to collect R-410A refrigerant at the outdoor unit side, Hydro unit Ht will not work if water temperature is under 33°C. Perform refrigerant collecting operation after warming water up over 33°C.
- All other indoor units should perform the heating or stop, when R-134a refrigerant collecting operation.

Important information regulation regarding the refrigerant used

- ▶ DVM Hydro unit HT contains fluorinated greenhouse gases.
- ▶ Do not vent gases into the atmosphere.
- ▶ Refrigerant type : R-134a
- ▶ Quantity: 2.15 kg (3.075 tCO₂e)
- ▶ Global Warming Potential(GWP) = 1430
- ▶ Hermetically sealed equipment

Please fill in the following with indelible ink on the refrigerant charge label supplied with this product and on this manual.

- ▶ ① the factory refrigerant charge of the product.
 - ▶ ② the additional refrigerant amount charged in the field.
 - ▶ ①+② the total refrigerant charge.
- * The refrigerant charge label supplied with the product.

Unit	kg	tCO ₂ e
①, a		
②, b		
①+②, C		

Refrigerant type	GWP value
R-410A	2088

- GWP=Global Warming Potential
- Calculating tCO₂e : kg x GWP / 1000



- a Factory refrigerant charge of the product: see unit name plate.
- b Additional refrigerant amount charged in the field. (Refer to the above information for the quantity of refrigerant replenishment.)
- c Total refrigerant charge.
- d Refrigerant cylinder and manifold for charging.



- The filled-out label must be adhered in the proximity of the product charging port. (ex. onto the inside of the stop valve cover.)
- The F-GAS label must be adhered in the proximity of the product.

12. Installation

Hydro Unit

Installing the drain pipe

Installing the drain pipe

- ▶ Use a spirit level to make sure that product is horizontally leveled.
- ▶ Choose one of the 2 drain holes on the bottom of the product and insert the provided drain plug, then connect the drain pipe.
- ▶ From the 2 drain holes, block the unused hole with the provided rubber plug.
- ▶ Install the drain pipe at the rear side of the unit to get a sufficient space for repairs and service on the front side.
- ▶ Do not install a trap on the pipe and install the drain pipe horizontally with a slope of 1/50 or more to prevent water from flowing backwards.
- ▶ For smooth drainage, install an air vent that is open to air.
- ▶ Insulate the drain pipe and drain plug with insulation over 10 mm.
- ▶ Install self-regulating heat cable on the drain pipe to prevent it from being frozen.
- ▶ Install the safety equipment for a heating appliance.

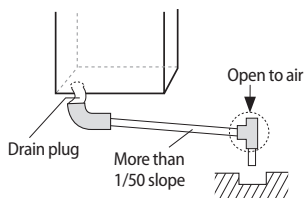

When concentrated drainage is installed

- ▶ Install a concentrated drain pipe with an air vent that is open to air.

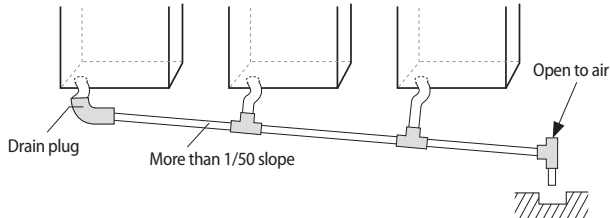

Checking the water leakage

Prepare about 2 liters of water and pour water into the drain pan of the DVM Hydro unit / Hydro unit HT as shown in the illustration.

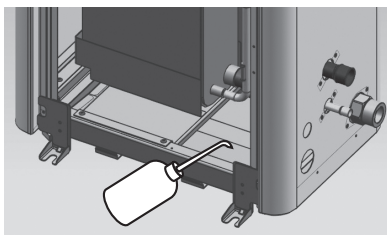

<DVM hydro unit>

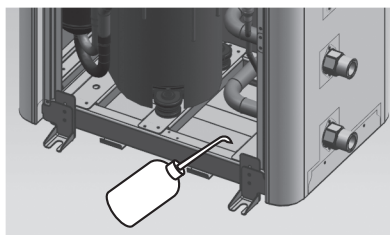

<DVM hydro unit HT>

12. Installation

Hydro Unit

Water pipe installation

1. Use closed type water pipe and closed type expansion tank when constructing water piping system.
2. Water pipe installation system
 - 1) Install the water pipe as shown in the below illustration. All the parts, other than DVM Hydro unit / Hydro unit HT, must follow on site installation specification.

<Water pipe connection part>

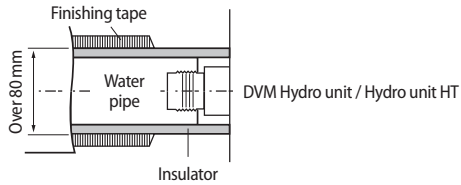

► Installing hot water supply

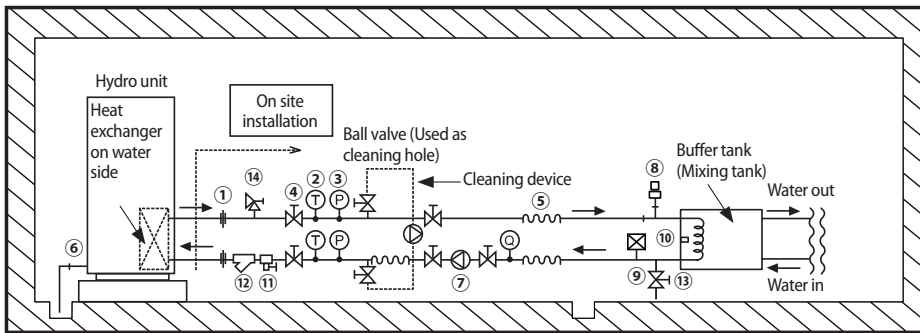

①	Water pipe joint (union, flange)	⑤	Flexible joint	⑨	Expansion tank
②	Thermometer	⑥	Drain (within the product)	⑩	Temperature sensor for hot water tank
③	Manometer	⑦	Pump	⑪	Drain valve
④	Ball valve	⑧	Air vent	⑫	Strainer
⑬	Water Valve	⑭	Pressure relief valve (Pressure safety valve)		

► Installing under floor heating

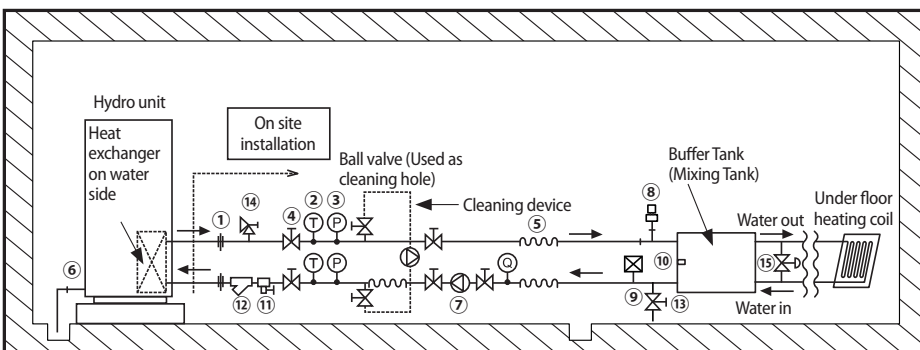

①	Water pipe joint (union, flange)	⑤	Flexible joint	⑨	Expansion tank
②	Thermometer	⑥	Drain (within the product)	⑩	Temperature sensor for thermal storage tank
③	Manometer	⑦	Pump	⑪	Drain valve
④	Ball valve	⑧	Air vent	⑫	Strainer
⑬	Water Valve	⑭	Pressure relief valve (Pressure safety valve)	⑮	Differential Pressure bypass Valve

12. Installation

Hydro Unit

When more than two water pipes are used for heating (e.g. Floor + Fan Coil Unit), Buffer Tank (Mixing Tank) or bypass valve should be used to maintain the water flow rate.

► On site installation specification

Model name	Strainer	Flow meter	Thermometer	Manometer	Air vent	Pump	Ball valve	Drain valve
AM160TNBF**	#50 PT 1	0~50 ℓ/min	0~100 °C	0~1 MPa	0.6 m³/h (Condition: 0.15 MPa)	23 ℓ/min	PT 1	15 A
AM250TNBF**		0~100 ℓ/min				36 ℓ/min		

Water pipe installation

- 2) Water pipe socket must be connected with a less tightening torque value stated in the below table. If you apply more torque, it may cause damage to the product.

Diameter of water pipe (Outer diameter, mm)	Tightening torque (N·m)
ø10~20	25
ø21~30	50
ø31~50	100
ø51~80	220
ø81~115	600

* 1 N·m = 10 kgf·cm

- 3) Use certified parts for water pipe system and the water pressure of the water pipe system connected to outdoor unit must remain under 1.0 MPa. Use copper or stainless pipe water pipe.
- 4) Water pipes must be equipped with valves and other instrumentations as shown in the diagram. Strainer must be installed within 1~2 m from the entrance pipe of the DVM Hydro unit / Hydro unit HT.
- When strainer is not installed, sand, dust or rust debris may cause product breakage.
 - Make sure that the strainer mesh is made of stainless steel.
- 5) Water inlet pipe is located at the bottom part of the heat exchanger and the water outlet pipe is at the top part of the heat exchanger.
- 6) DVM Hydro unit / Hydro unit HT must be installed indoor at room temperature and the water inlet and outlet must be insulated as shown in the 'Water pipe installation system' diagram on page 22.
- 7) Damp-proof, cold reserving and insulation work must be done thoroughly to prevent condensation from forming on the surface of the product and drain pipes of indoor/outdoor units. When the necessary work is not done thoroughly, you will waste energy caused by thermal loss and may get property damage during cold seasons when water pipe freezes and bursts.
- 8) If you stop the product for long time or in night time, water pipe circuit may freeze naturally when the temperature around the DVM Hydro unit / Hydro unit HT is under 0 °C. When water pipe circuit freezes, it will cause damage to the plate type heat exchanger and therefore preventive measure must be taken according to the situation.
- Drain remaining water in the water pipe
 - Install self-regulating heat cable on the water pipes
 - If the product is installed in a place where surround temperature drops below 0 °C, use anti-freeze accordingly for freezing point depression.
- 9) Install number of auto air discharge valve at a point where air may remain within the pipe (such as vertical water pipe). If the air within the pipe is not discharged, it may cause performance decrease or corrosion on the product or pipes.
- 10) Following is the operation range of water.

Section		Outlet water temperature (°C)		Amount of water (ℓ/min)	
		AM***TNBF**	AM160TNBF**	AM160TNBF**	AM250TNBF**
Standard condition	Cooling	-	-	-	-
	Heating	65	23	36	36
Operation range	Cooling	-	-	-	-
	Heating	25~80	14~46	14~72	14~72

- When the amount of cooling water is out of the operation range, stop the DVM Hydro unit / Hydro unit HT and take care of the cause before re-start the operation.
- Temperature of discharged water is very high so be careful not to come in contact with the body. Also, cover the external water pipe with appropriate insulator for insulation and preventing burns.

12. Installation

Hydro Unit

- 11) Water scale may occur on the plate type heat exchanger depending on the water quality and the type of plate heat exchanger so regular chemical cleaning is necessary. When installing water pipes, install a heat source water shut-off valve and also install the flushing pipe with a ball valves (for chemical cleaning) on the pipe installed between the shut-off valve and the outdoor unit.
- 12) Before trial operation, connect the cleaning pipes installed on inlet and outlet as shown in above illustration. Then, take appropriate measures (such as blind flange etc) to stop the circulation water from entering the outdoor unit plate type heat exchanger, and use circulating pump to remove foreign substance within the water pipes and clean the strainer. If you do not clean the strainer, foreign substances may accumulates on plate type heat exchanger and may break the heat exchanger or cause problem to it.
- 13) Make sure that water quality within the water pipe meets the standard of cooling water quality for refrigerating and air conditioning equipment.
 - Heat source water containing high level of foreign substances can cause water heat exchanger and pipe corrosion or creation of water scale. (Use the appropriate heat source water according to the below table)
 - If the make-up water is provide from any other source than local water supply, make sure to check the quality of water.
 - Strainer (which needs to be purchased separately) must be installed to the 'Water IN' pipes of the water pipe. If sand, dust or rust debris enters to water system, it may cause corrosion on metallic materials or blockage of the water heat exchanger and damage the heat exchanger.
 - If the existing thermal storage tank or pipes are used, foreign substances may block the plate type heat exchanger of the DVM Hydro unit / Hydro unit HT so, water quality and foreign substances must be managed.
- 14) Check that the total water volume in the installation, excluding the internal water volume of DVM Hydro unit / Hydro unit HT, is 20L minimum.

Section	Item	Closed circuit system		Effects		Recommended number for water quality inspection
		Heat source water	Make-up water	Corrosion	Scale	
Standard value	pH[25 °C]	7.0 ~ 8.0	7.0 ~ 8.0	○	○	Once a year
	Electric conductivity [25 °C] (mS/m)	30 and below	30 and below	○	○	
	Chloride ion (mg Cl/L)	50 and below	50 and below	○		
	Sulfate ion (mg SO ₄ ²⁻ /L)	50 and below	50 and below	○		
	M alkali level [pH 4.8](mg CaCO ₃ /L)	50 and below	50 and below		○	
	Total hardness (mg CaCO ₃ /L)	70 and below	70 and below		○	
	Calcium hardness (mg CaCO ₃ /L)	50 and below	50 and below		○	
	Ionized silica (mg SiO ₂ /L)	30 and below	30 and below		○	
Reference	Iron (mg Fe/L)	1.0 and below	0.3 and below	○	○	
	Copper (mg Cu/L)	1.0 and below	1.0 and below	○		
	Sulfate ion(mg S ²⁻ /L)	Not to be detected	Not to be detected	○		
	Ammonium ion (mg NH ₄ ⁺ /L)	0.3 and below	0.1 and below	○		
	Residual chlorine (mg Cl/L)	0.25 and below	0.3 and below	○		
	Free carbon dioxide (mg CO ₂ /L)	0.4 and below	0.4 and below	○		
	Stability index	-	-	○	○	



NOTE

- Circle (O) marks in the chart show the factor relevant to corrosion or water scale.
- When the water temperature is over 40°C, steels without protective coating may corrode when expose to water. Applying corrosion prevention material or degassing can be effective measure to prevent corrosion.
- For the cooling water and the make-up water, used under closed circuit water system with closed circuit cooling tower, should satisfy the standard shown in above table.
- Supplied water or make-up water should be tap water, industrial water. Purified water, neutralized water and softened water should not be supplied.
- 15 items in the above table is a typical factor for corrosion and/or water scale.
- When water pipe circuit freezes, it will cause breakage on the plate type heat exchanger. Therefore appropriate preventive measure must be taken according to the situation.
 - Drain remaining water in the water pipe
 - Constantly operate the water pump to circulate the water within the water pipe
 - Install a self-regulating heat cable on the water pipe
- Open the valve of the water pipe connected to the outdoor unit after flushing (cleaning foreign substances in water pipe) is completed.
- Check that air is vented from the water pipe and circulation amount is secured before opening the service valve on the refrigerant side of the outdoor unit.
- When circulating water stops during outdoor nit operation, it may cause breakage on plate type heat exchanger.

12. Installation

Hydro Unit

Pressure drop graphs

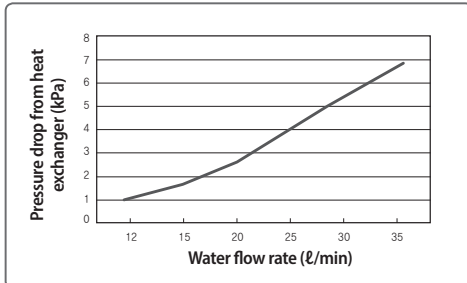

Connecting strainer

- ▶ Use a strainer with 50 mesh (Diameter of each hole must be under 0.4 mm, excluding punching plate)
- ▶ Connect the strainer after checking the direction of the strainer on the water inlet hole as shown in the illustration.
- ▶ Wind the Teflon tape more than 15 times on the thread of the water pipe before connecting it.
- ▶ Service port must face downward and angle should be within 45° on the left and the right side.
- ▶ After installing the strainer, makes sure that there is no water leakage on the connection part.
- ▶ For normal operation of the product, clean the strainer regularly (more than once a year).

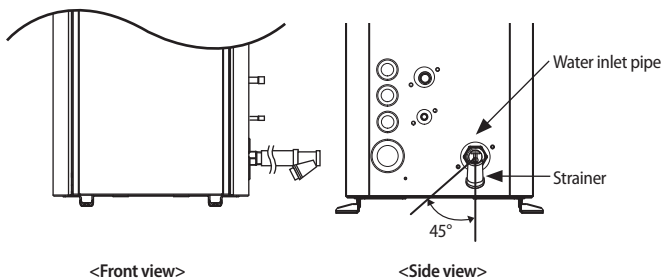

Connecting power and communication cable

Specification of electric wires

Indoor unit	Power supply	MCCB [A]	ELB [A]	Power cable (mm ²)	Earth cable (mm ²)	Communication cable (mm ²)
DVM Hydro unit HT	1Ø, 220~240V/50 Hz Max: 264 V Min: 198V	X [A]	X [A], 30 mA, 0.1 sec ↓	4.0 mm ² ↑ (Single Installation)	2.5 mm ²	0.75~1.5 mm ²
	3Ø, 380~415V/50 Hz Max: 456.5 V Min: 342V	X [A]	X [A], 30 mA, 0.1 sec ↓	2.5 mm ² ↑ (Single Installation)		

This Equipment complies with IEC 61000-3-12, provided that the short-circuit power S_{sc} is greater than or equal to 3.881 M at the interface point between the user's supply and the public system. It is responsibility of the installer or user of the equipment to ensure, by consultation with the distribution network operator if necessary that the equipment is connected only to a supply with a short-circuit power S_{sc} greater than or equal to 3.881 M

12. Installation

Hydro Unit

* Table for current (Single installation)

Indoor unit	Model	Rated current (A)	MCA (A)	MFA (Min. ELCB, MCCB, A)
DVM Hydro unit HT	AM160TNBFE*	14.3	18.0	25.0
	AM250TNBFE*	23.1	30.0	40.0
	AM160TNBFG*	4.85	16.1	20.0
	AM250TNBFG*	7.85	16.1	20.0

► Decide the power cable specification and maximum length within 10 % power drop among indoor units.

$$\sum_{k=1}^n \left(\frac{\text{Coef} \times 35.6 \times L_k \times i_k}{1000 \times A_k} \right) < 10\% \text{ of input voltage [V]}$$

- coef: 1.55
- L_k: Distance among each indoor unit [m], A_k: Power cable specification [mm²]
- i_k: Running current of each unit [A]

Example of Installation

- Total power cable length L = 100(m), Running current of each units 1[A]
- Total 10 indoor units were installed

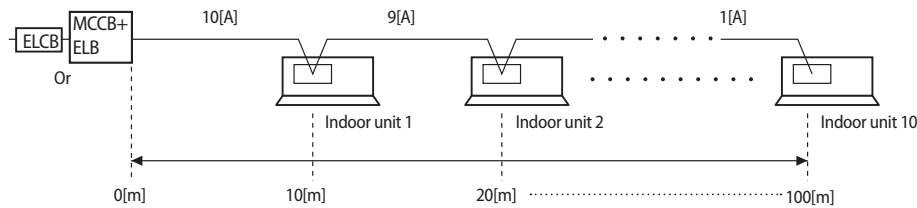

► Apply following equation

$$\sum_{k=1}^n \left(\frac{\text{Coef} \times 35.6 \times L_k \times i_k}{1000 \times A_k} \right) < 10\% \text{ of input voltage [V]}$$

* Calculation

- Installing 1 type of wire.

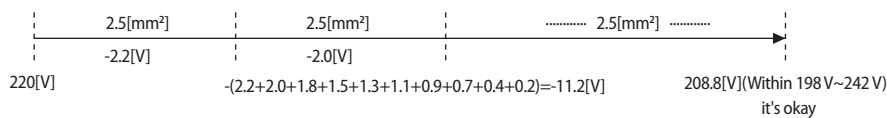

- Installing with 2 different sort wire.

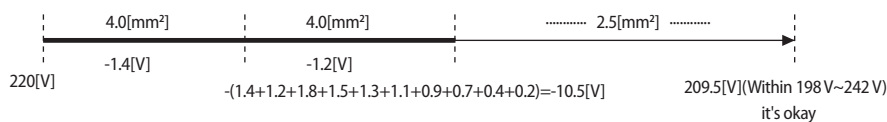

12. Installation

Hydro Unit

Connecting power and communication cable

DVM Hydro unit HT

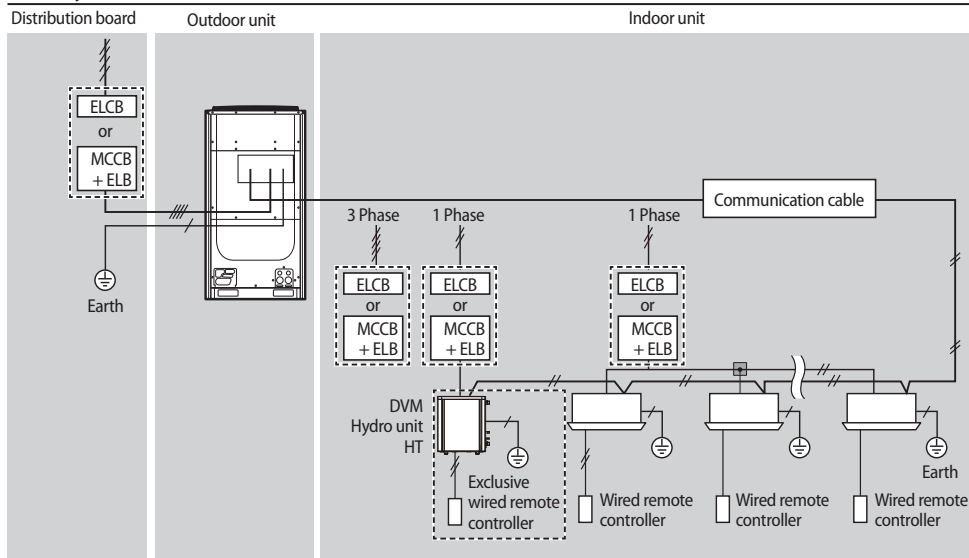

- Do not divide communication cable multiple times from one indoor/DVM Hydro unit / Hydro unit HT to another. It may cause communication error.
- Do not divide power cable multiple times from one Hydro unit HT to another. DVM Hydro unit HT can get a damage.
- Power supply cords of parts of appliances for outdoor use shall not be lighter than polychloroprene sheathed flexible cord. (Code designation IEC:60245 IEC 57 / CENELEC: H05RN-F) (ADN***BDE** / AM***FNBD** Model)
- Power supply cords of parts of appliances for outdoor use shall not be lighter than polychloroprene sheathed flexible cord. (Code designation IEC:60245 IEC 66 / CENELEC: H07RN-F) (AM***FNBF** / AM***TNBF** Model)

Power supply and communication cable configuration

- Withdraw a main power cable and a grounding cable through the cable outlet on the right side of the DVM Hydro unit / Hydro unit HT.
- When connecting external contact signal wire, connect them to the PCB terminal board through the cable outlets in the right side of the outdoor unit.
- Wires must be installed after putting them in separate cable protection tubes.
- Fix a cable tube at the cable outlet using a CD connector.

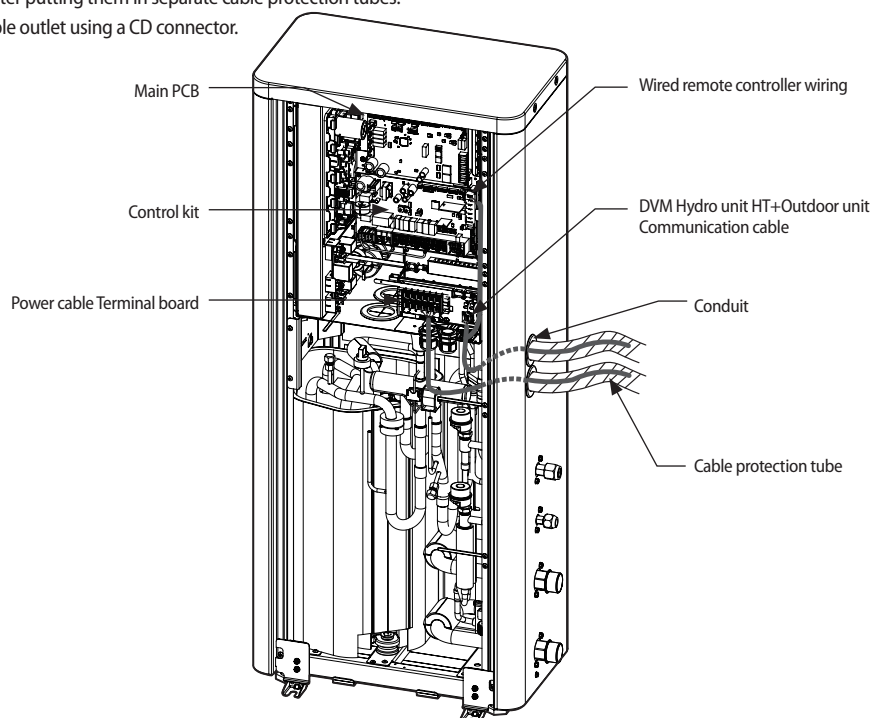

12. Installation

Hydro Unit

Specifications of the cable protection tube

Name	Material	Applicable conditions
Flexible PVC conduit	PVC	When the cable tube is installed indoor and not exposed to outside, because it is embedded in concrete structure
Class 1 flexible conduit	Galvanized steel sheet	When the cable tube is installed indoor but exposed to outside so there are risk of damage to the cable tube
Class 1 PVC coated flexible conduit	Galvanized steel sheet and Soft PVC compound	When the cable tube is installed outdoor and exposed to outside so there are risk of damage to the cable tube and extra waterproof is needed

Power and communication wiring diagram

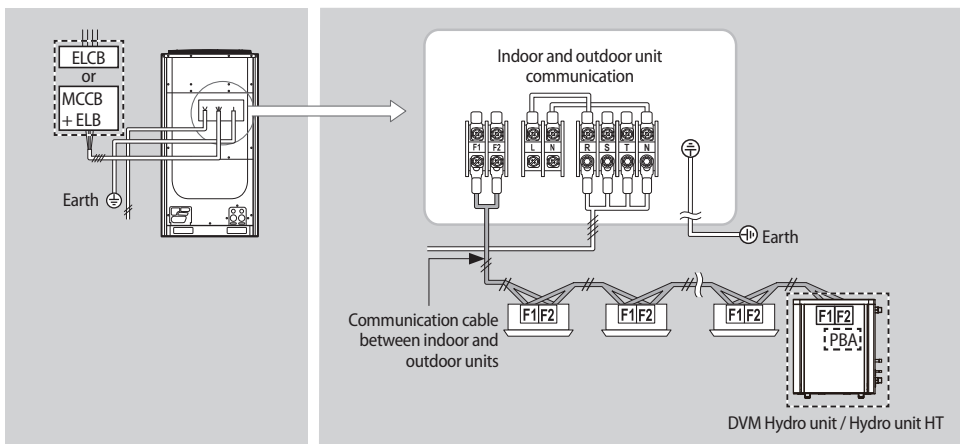

- ▶ The communication cable between indoor and outdoor units has no polarity.
- ▶ Arrange the cables using a clamp attached on the left side of the terminal board.
- ▶ When you connect the power cable, you must apply rated tightening torque to connect the screws for the terminal board.

PBA connection diagram

- Single phase

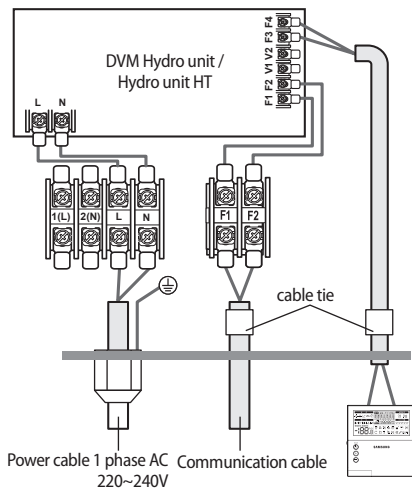

- Three phase

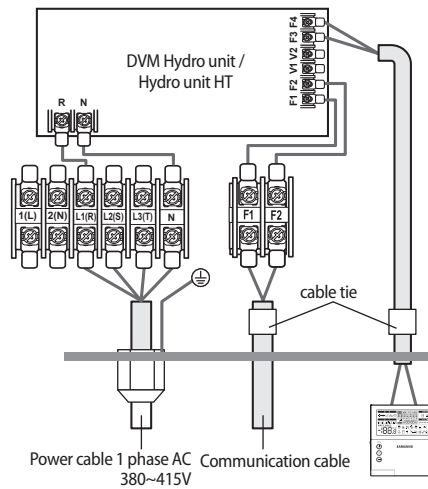

12. Installation

Hydro Unit

Wiring diagram for connecting 2 wired remote controllers

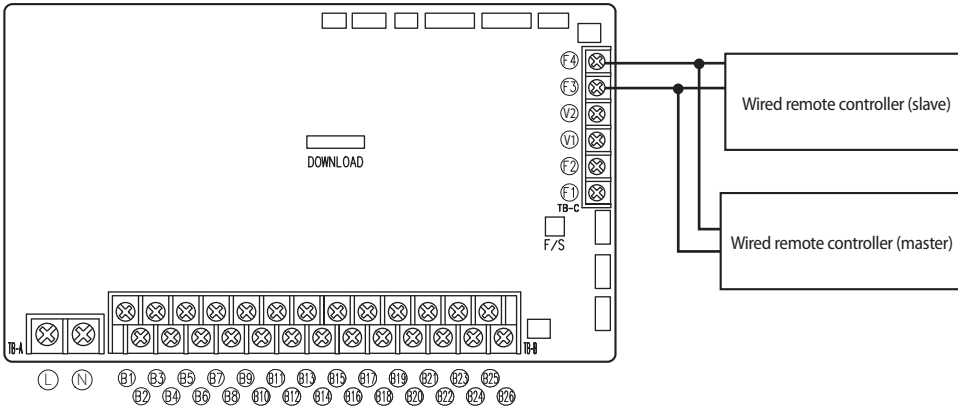

Connecting the power terminal

- ▶ Connect the cables to the terminal board using a solderless ring terminal.
- ▶ Properly connect the cables by using certified and rated cables and make sure to fix them properly so that external force is not applied to the terminal.
- ▶ Use a driver and wrench that can apply the rated torque when tightening the screws on the terminal board.
- ▶ Tighten the terminal screws by complying rated torque value. If the terminal is loose, arc heat may occur and cause fire and if the terminal is connected too firmly, terminal may get damaged.

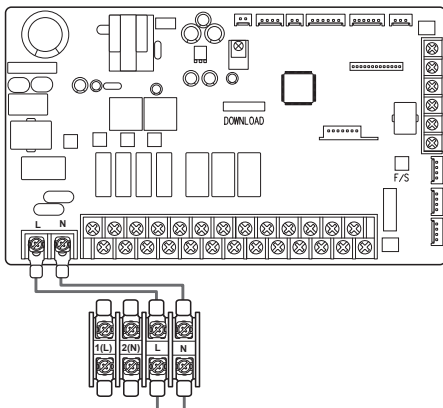

12. Installation

Hydro Unit

Connecting external contact

External contact connection diagram

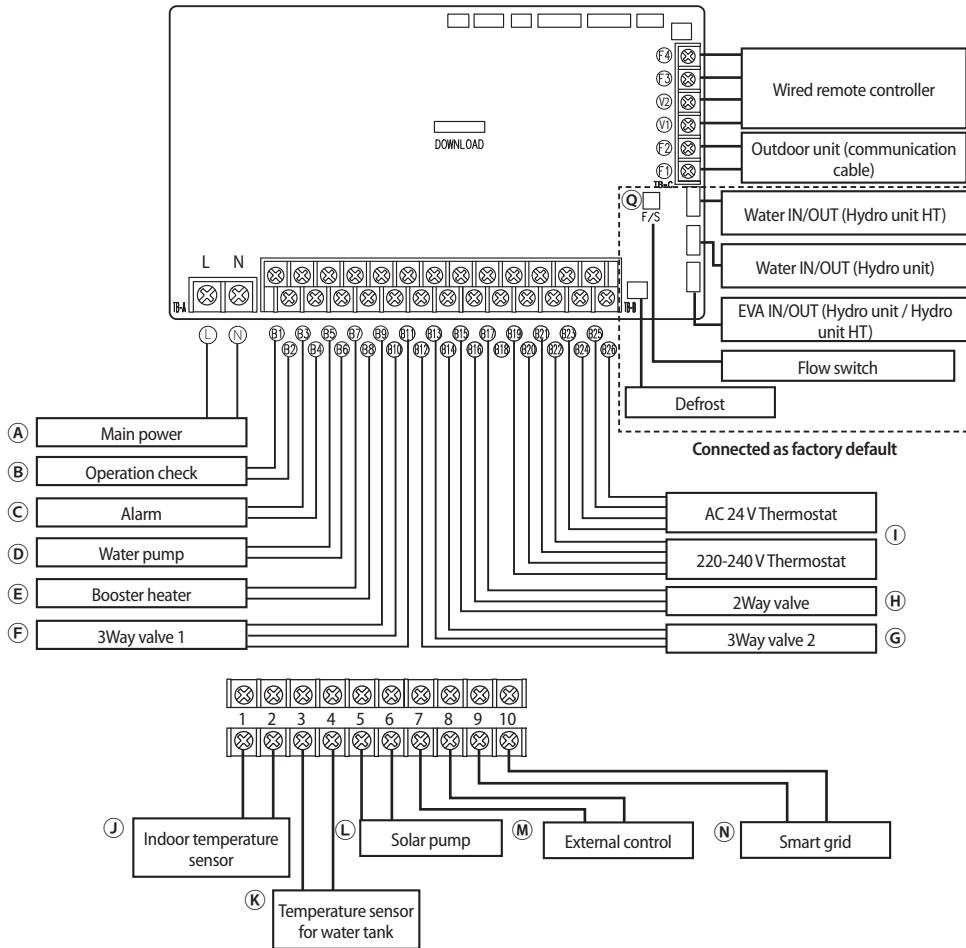

<DVM Hydro unit HT>

	Explanation	Terminal No.	Input / Output	AC/DC	Maximum allowable current
A	Power	L, N	Input	AC	2.5 A
B	Operation check	B1, B2	Contact output	-	0.5 A
C	Alarm	B3, B4	Contact output	-	0.5 A
D	Water pump	B5, B6	Contact output	-	0.5 A
E	Booster heater	B7, B8	Contact output	-	0.5 A
F	3Way valve 1	B9 ~ B11	Output	AC	0.5 A
G	3Way valve 2	B12 ~ B14	Output	AC	0.5 A
H	2Way valve	B15 ~ B17	Output	AC	0.5 A
I	AC 230, AC 24V Thermostat	B19 ~ B26	Input	AC	10 mA
J	Separately installed indoor temperature sensor (MRW-TA)	1,2(1,2)	Input	DC	1 mA

12. Installation

Hydro Unit

Explanation		Terminal No.	Input / Output	AC/DC	Maximum allowable current
K	Temperature sensor for water tank	7,8(3,4)	Input	DC	20 mA
L	Solar pump	13,14(5,6)	Contact input	-	10 mA
M	External control	16,17(7,8)	Contact input	-	1 mA
N	Smart grid	19,20(9,10)	Input	DC	1 mA
O	Communication cable (RS485)	F1, F2	Input, Output	DC	10 mA
P	Wired remote controller	V1	Output	DC	210 mA (per each controller)
		V2	Grounding	-	-
		F3, F4	Input, Output	DC	10 mA
Q	Flow switch	F/S	Input	DC	1 mA

* (): Hydro unit HT

* For instruction regarding on wiring power, communication and wired remote controller, refer to "Connecting power and communication cable" chapter.

* External control: Operation On or Off by external contact signal

* Smart grid: Set by remote controller FSV

FSV#5041 : Default is 0 (Disable)

FSV#5042 : 0 (default) While the external contact is maintained as High, disable all heat source (heater).

1 Use Booster Heater only

Connecting external contact

► Refer to the below table for the terminal numbers that needs on the site for connecting external contact.

Terminal No.	External contact	Function	Remarks
B1, B2	Operation check	Output operation status	Optional
B3, B4	Alarm	Output alarm status	Optional
B5, B6	Water pump	Output operation signal for a water pump	Mandatory
B7, B8	Booster heater	Output operation signal for booster heater of DHW tank	Optional
B9~B11	3Way valve 1	Output 3 way valve direction signal for indoor heating / DHW selection	Optional
B12~B14	3Way valve 2	Output for solar pump interconnection/defrost signal interconnection	Optional
B15~B17	2Way valve	Output 2 way valve switching signal for blocking cold water fall in floor cooling	Optional
B19, B20	AC230, Thermostat 1	Input thermostat signal for cooling (AC 220-240 V)	Optional
B21, B22	AC230, Thermostat 2	Input thermostat signal for heating (AC 220-240 V)	Optional
B23, B24	AC24, Thermostat 1	Input thermostat signal for cooling (AC 24V)	Optional
B25, B26	AC24, Thermostat 2	Input thermostat signal for heating (AC 24V)	Optional
1, 2 (1, 2)	Indoor temperature sensor	Connect indoor temperature sensor (Connection status can be checked on the wired remote controller.)	Optional
7, 8 (3, 4)	Temperature sensor for water tank	Connect temperature sensor of DHW tank (Connection status can be checked on the wired remote controller.)	hot water supply operation
13, 14 (5, 6)	Solar pump	Input contact signal for solar heat pump operation	Optional
16, 17 (7, 8)	External control	Input external contact control signal (Refer to seg 14 of 02 series remote controller installation option.)	Optional
19, 20 (9, 10)	Smart grid	Input contact signal for smart grid	Optional

* (): Hydro unit HT

* You may need to set different field specifications for the wired remote controller depending on the function.

12. Installation

Hydro Unit

Water pump connection

- ▶ Connect a water pump to B5, B6 of the PBA terminal block.

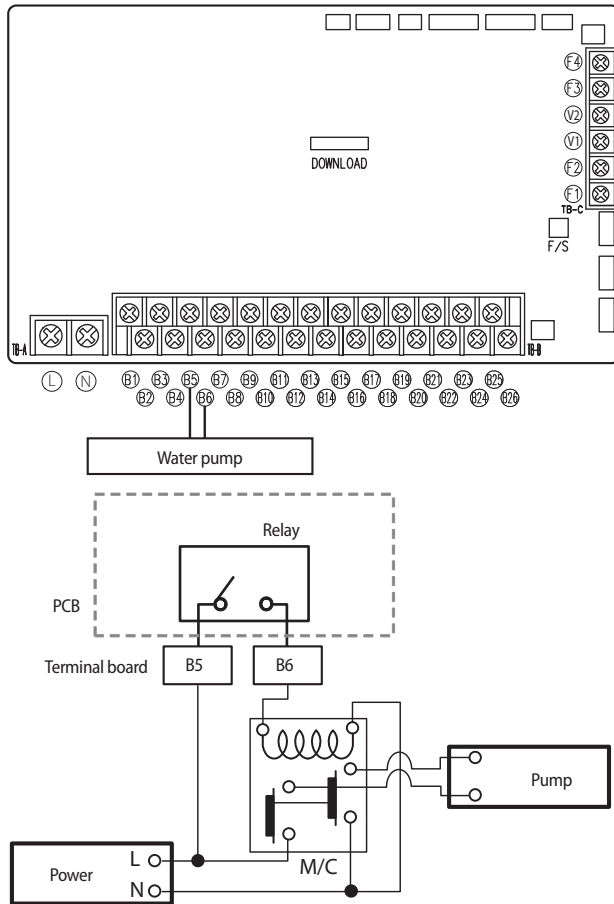

• Terminal of this product is for water pump and the maximum allowable current is 0.5 A

Specification table

Part	Specification
Terminal block (Output)	B5, B6
Connection type	Water pump (No-voltage contact)

12. Installation

Hydro Unit

Booster heater connection

- ▶ Connect a booster heater to B7, B8 of the PBA terminal block.

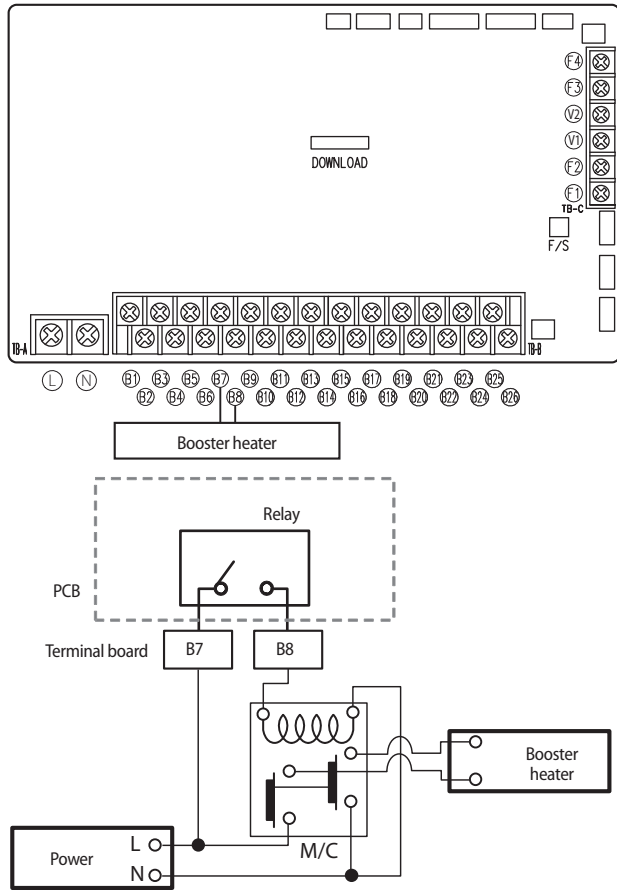

Specification table

Part	Specification
Terminal block (Output)	B7, B8
Connection type	Booster heater (No-voltage contact)

12. Installation

Hydro Unit

3Way valve connection

- ▶ Check the type of 3Way valve and connect it to the terminal board as shown in the illustration.
- ▶ Use a rated wire and connect it as shown in the illustration.
- ▶ 3 Way valve 1: When the valve is connected to B9 and B11, its direction should be indoor side.
- ▶ 3 Way valve 2: When the valve is connected to B12 and B14, its direction should be tank side.

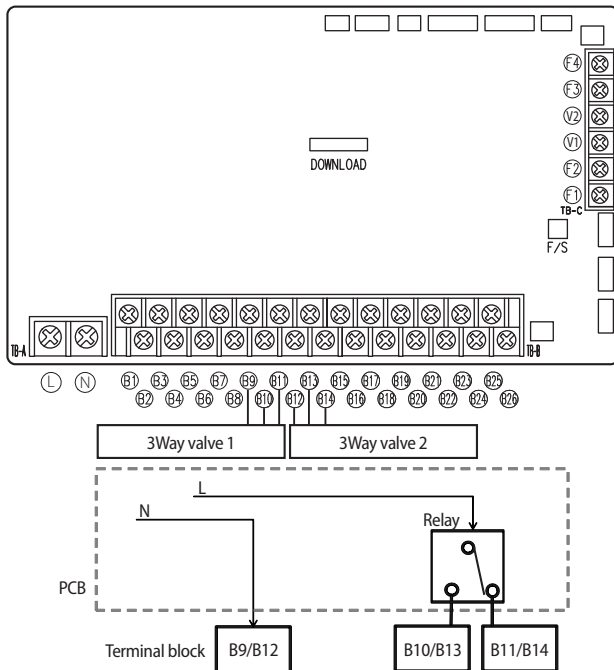

* Initially, relay is connected between L and B11/B14 of the terminal block.



• Before completing installation of 3Way valve, check the opening direction of the port.

Part	Specification
Output (B9 ~ B11, B12 ~ B14)	AC 220 - 240 V (Max 0.5A / 120W)

Allowed connection

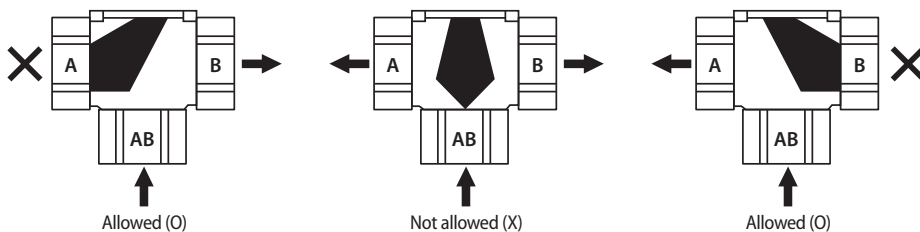

12. Installation

Hydro Unit

Example of installation (Danfoss H-series valve)

► Connecting the valve

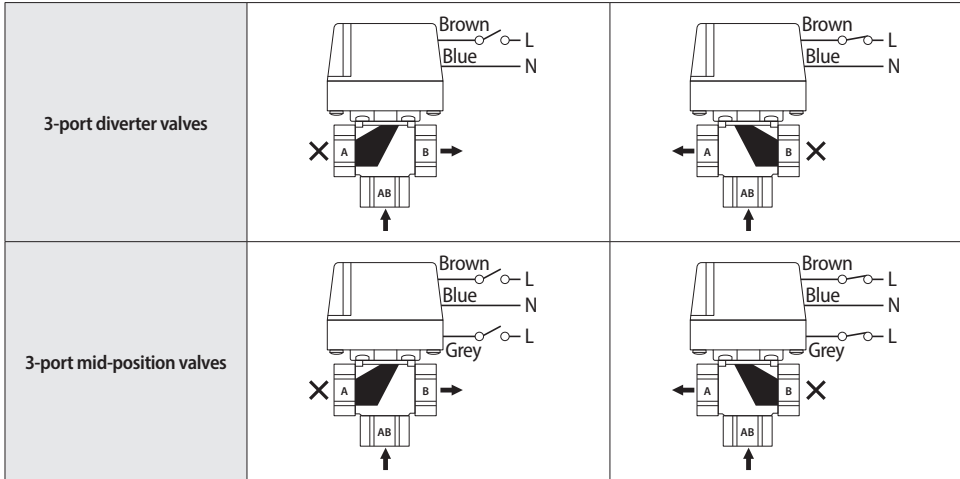

► Example of wiring

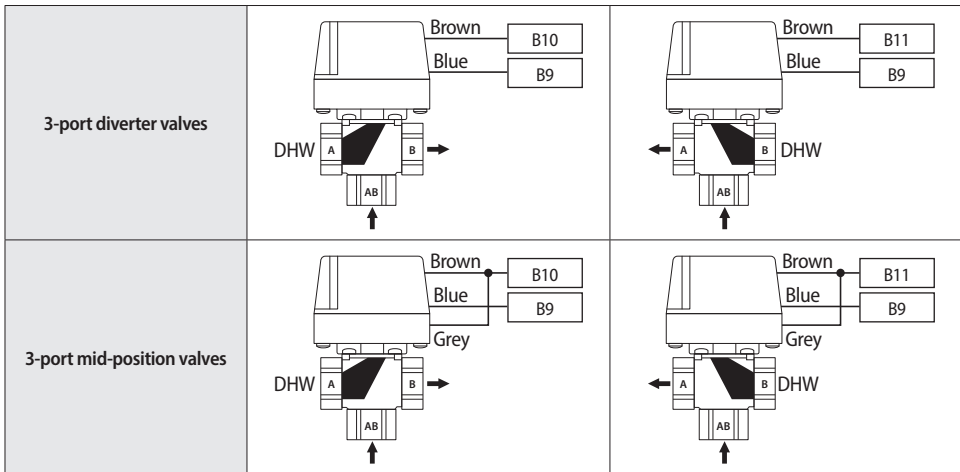

* Connect B12/B13 (3 Way valve 2) of the terminal block to use the defrost mode contact output.

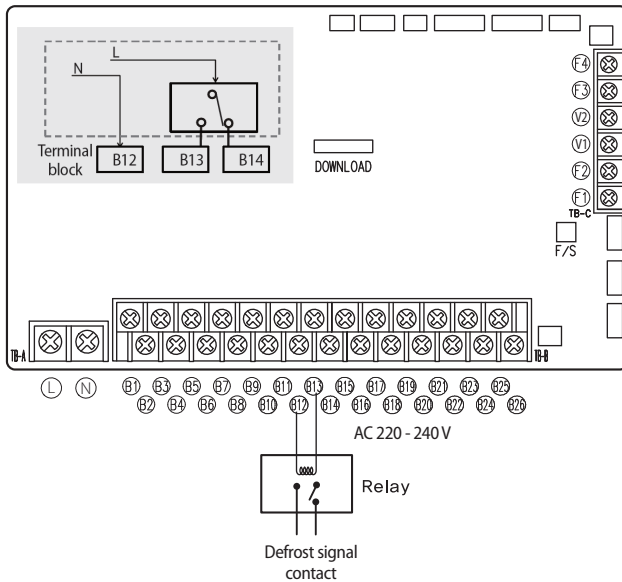

12. Installation

Hydro Unit

Connecting 2Way valve

- ▶ Connect a 2Way valve to B15, B16 and B17 of the PBA terminal block.
- ▶ 2Way valve is interlocked with 3Way valve 1.

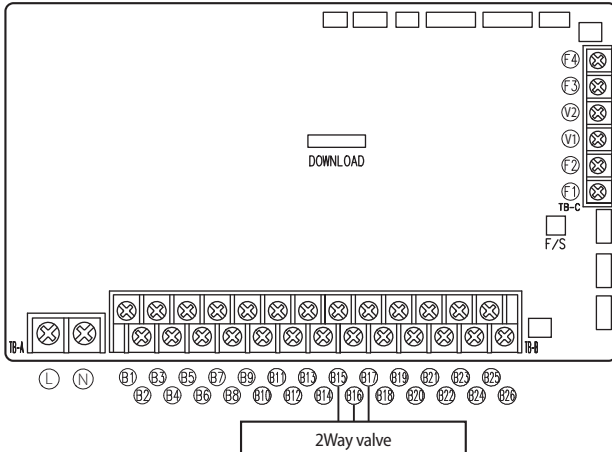

* Initially, relay is connected between L and B17 of the terminal block.



• Terminal of this product is for 2Way valve and the maximum allowable current is 0.5 A

Specification table

Part	Specification
Terminal block (Output)	B15: Output power N B16: Output power L (switch type) B17: Output power L (switch type)
Connection type	Directly connect 2Way valve (below 0.5 A)
Output (B15~B17)	AC 220 - 240 V (Max 0.5A / 120W)

Wiring 2Way valve

When floor cooling and fan coil unit cooling operate at the same time, 2 way valve prevent temperature drop of the floor.

- ▶ Use a rated wire to connect it as shown in the illustration and fix it with a cable tie.
- ▶ Initial setting of the valve is 'closed (no flow)'.

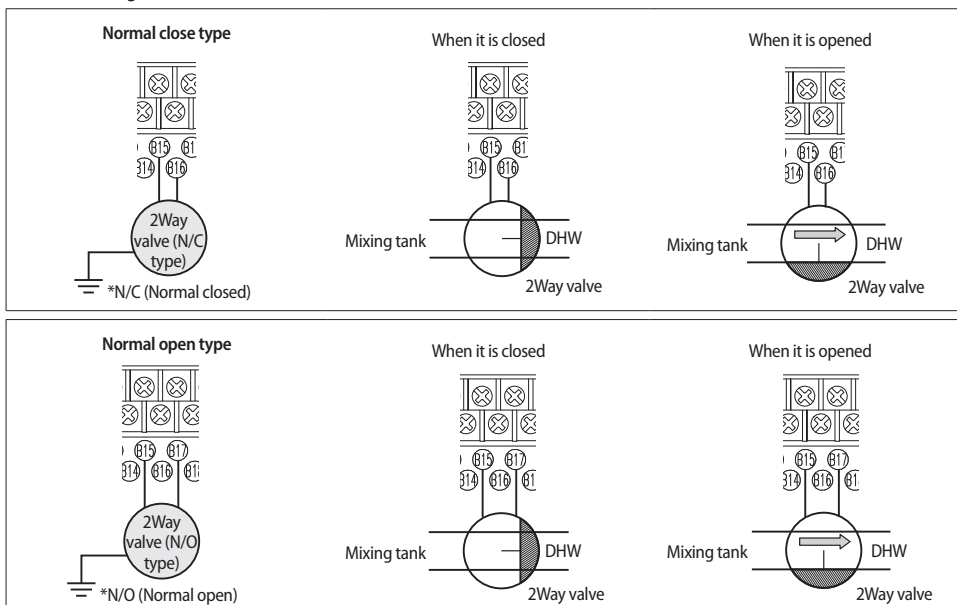

• Wiring is different for a N/C (Normal closed) valve and N/O (Normal open) valve.

12. Installation

Hydro Unit

AC 220-240 V or AC 24V thermostat

- ▶ Connect the indoor thermostat to B19~B26 of the PBA terminal block.
- ▶ Connect a thermostat to the designated terminal as stated in the rated table.
- ▶ Only 1 type of thermostat can be connected. (B19~B22 or B23~B26)
- ▶ Product will not operate when signal for cooling and heating mode is inputted at the same time.

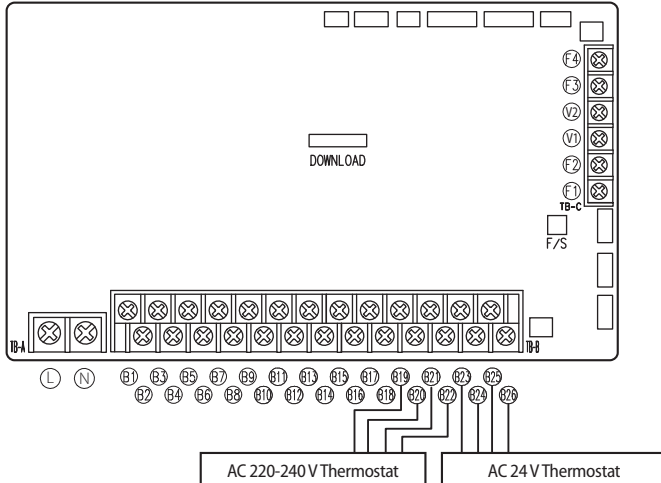

CAUTION • Maximum allowable current of each terminal is below 10mA

Specification table

Part	Specification
Terminal block (AC 220-240 V)	B19: Output power L (for cooling mode) B20: Input power N (for cooling mode) B21: Output power L (for heating mode) B22: Input power N (for heating mode)
Terminal block (AC 24V)	B23: Output power L (for cooling mode) B24: Input power N (for cooling mode) B25: Output power L (for heating mode) B26: Input power N (for heating mode)
Connection type	Connect to indoor power controller
Input (B19~B22)	AC 220-240 V (Maximum 10 mA)
Input (B23~B26)	AC 24V (Maximum 10 mA)
Condition for operation	When B20 or B24 is detected -> cooling mode When B22 or B26 is detected -> heating mode

AC 220-240 V thermostat

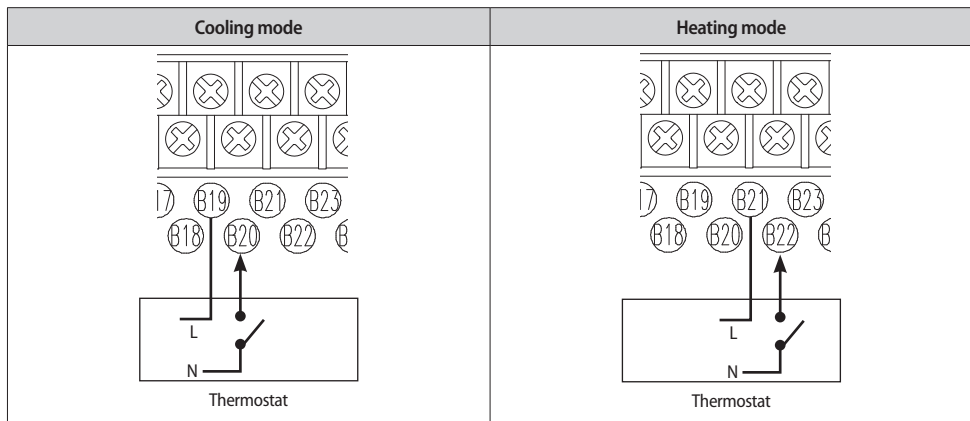

12. Installation

Hydro Unit

AC 24V thermostat

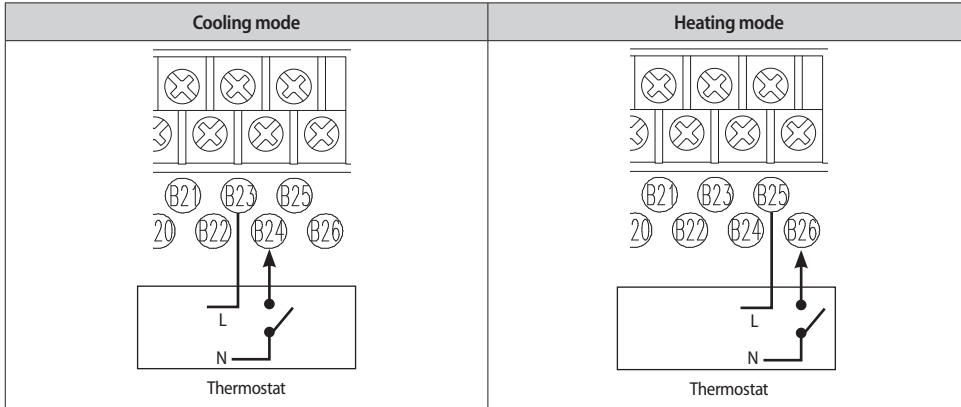

Connecting temperature sensor of water tank and flow switch

- ▶ Connect the temperature sensor of water tank to number 7 and 8 of the terminal block located on the bottom side.
- ▶ Connect 4~20 mA temperature sensor for water tank. When there is more than one unit, at least one of them should be connected directly to the temperature sensor.

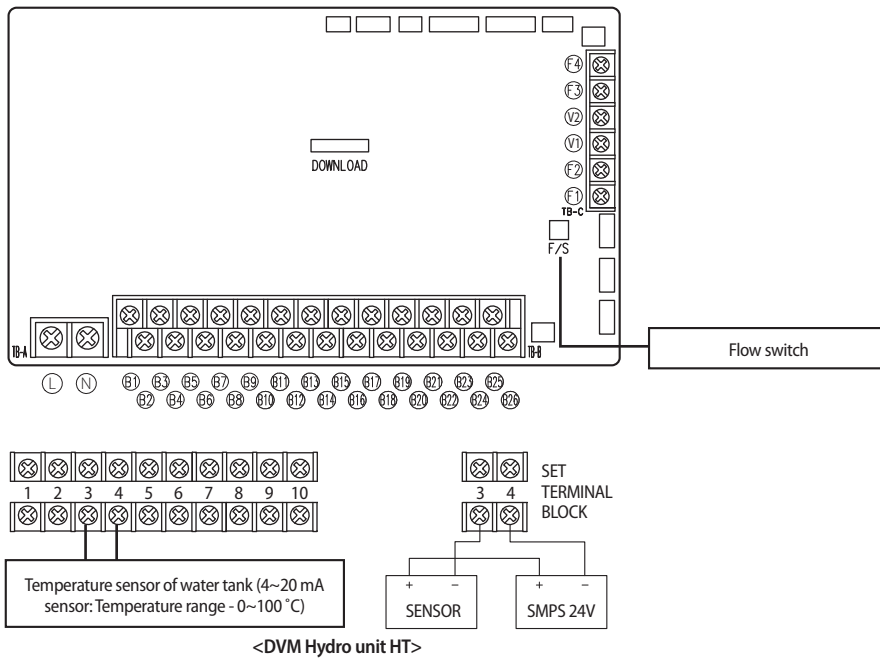

12. Installation

Hydro Unit

Connecting solar pump

- ▶ Connect the signal wire for solar pump to number 13 and 14 (HT: 5. 6) of the terminal block located on the bottom side.

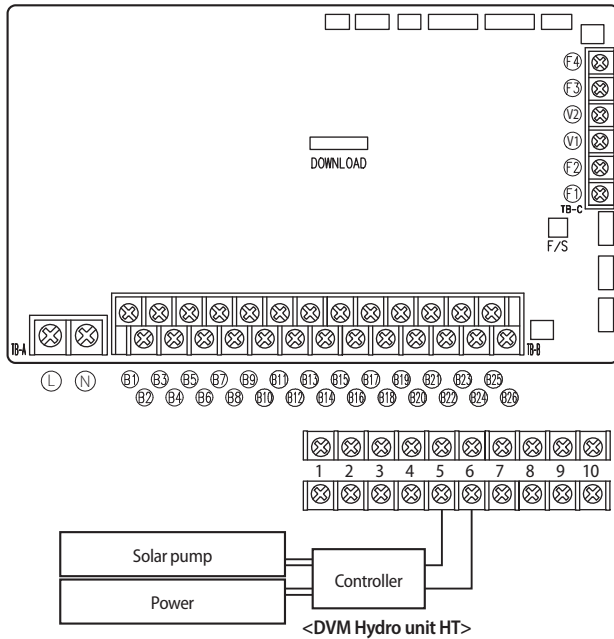

CAUTION

- Maximum allowable current of each terminal is below 10 mA.
- Ports number 13 and 14 (HT: 5. 6) is for input port for detection and they do not supply power to a solar pump.

Specification table

Part	Specification
Terminal block (Input)	13 and 14 (HT: 5. 6): No-voltage contact
Connection type	Connect to solar pump controller (contact signal)

System diagram for DVM Hydro unit HT

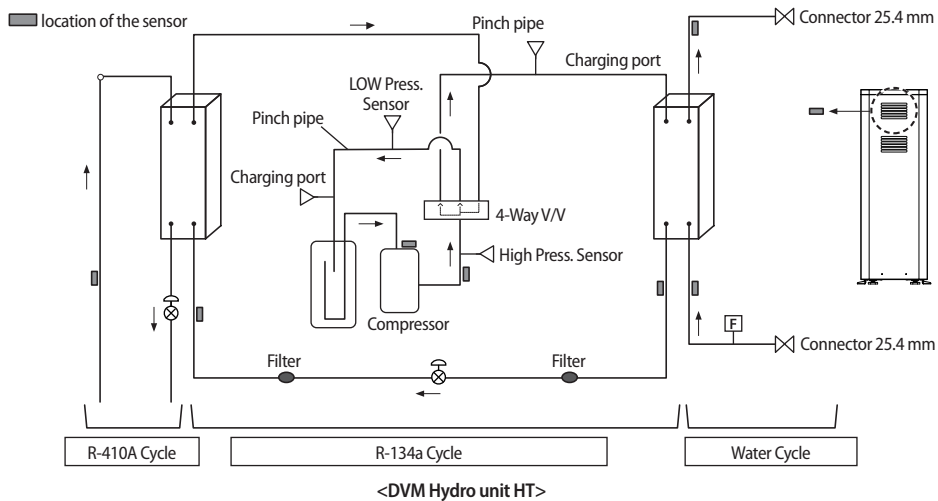



2020.09
Ver.1.0

Samsung Electronics Co., LTD.

Head Office (Suwon Korea) 129, Samsung-Ro, Yeongtong-Gu, Suwon City, Gyeonggi-Do, Korea 16677
Website : www.samsung.com, <http://btsp.samsungsbn.com> Email : airconditioner@samsung.com
Images and data in this book may subject to change without prior notice.